



# **GROUNDWATER MANAGEMENT IN MINING AREAS**

Proceedings of the 2<sup>nd</sup> IMAGE-TRAIN  
Advanced Study Course

Pécs, Hungary, June 23-27, 2003



EUROPEAN COMMISSION  
RESEARCH DIRECTORATE-GENERAL



Universität  
Karlsruhe (TH)

UNIVERSITY OF  
NEWCASTLE



CONFERENCE PAPERS/TAGUNGSBERICHTE  
CP-035

Wien/Vienna, 2004



## **Projektleitung/Project Management**

Gundula Prokop

## **Editors**

Gundula Prokop, Umweltbundesamt, Spittelauer Lände 5, 1090 Vienna, Austria  
e-mail: gundula.prokop@umweltbundesamt.at

Paul Younger, University of Newcastle upon Tyne NE1 7RU Newcastle upon Tyne, UK  
e-mail: p.l.younger@ncl.ac.uk

Karl Ernst Roehl, Karlsruhe University, Kaiserstrasse 12, 76128 Karlsruhe, Germany  
e-mail: roehl@agk.uni-karlsruhe.de

## **Veranstaltungsorganisation/Event Organisation**

The Umweltbundesamt being responsible for the overall co-ordination of the meeting.

University of Newcastle upon Tyne being responsible for the course programme.

Karlsruhe University being responsible for the on-site organisation.

Mecsekerc Rt. functioning as host and being responsible for the excursion to the abandoned uranium mining areas near Pécs.

## **Veranstaltungsfinanzierung/Event Funding**

The European Commission Research Directorate General

## **Satz und Layout/Typesetting and Layout**

Elisabeth Lössl, Umweltbundesamt

## **Danksagung/Acknowledgement**

Special thanks are due to Dr. Mihaly Csöväri and his team from Mecsek Ore Environment Corporation in Pécs for organising and supporting this course and for providing their expertise for the on-site excursions.

## **Impressum**

Medieninhaber und Herausgeber: Umweltbundesamt GmbH  
*Published by:* Spittelauer Lände 5, 1090 Wien/Vienna, Austria

Die unverändert abgedruckten Einzelreferate geben die Fachmeinung ihrer Autoren und nicht notwendigerweise die offizielle Meinung des Umweltbundesamtes wieder.

*The publisher makes no representation, express or implied, with regard to the accuracy of the information contained in this book and cannot accept any legal responsibility or liability for any errors or omissions that may be made.*

Druck/Printed by: Manz Crossmedia

© Umweltbundesamt GmbH, Wien/Vienna 2004  
Alle Rechte vorbehalten/all rights reserved  
ISBN 3-85457-716-8

## **FOREWORD**

Innovative Management of Groundwater Resources in Europe – Training and RTD Co-ordination (IMAGE-TRAIN) is an initiative funded by the European Union's Research Directorate General and has the ambition to improve cooperation and interaction between ongoing research projects in the field of soil and groundwater contamination and to communicate new technology achievements to young scientists by means of training courses.

### **Mine water management in Pécs**

The 2<sup>nd</sup> IMAGE-TRAIN Advanced Study Course was held in Pécs, Hungary from June 23 to 27 2003 and focused on mine water management. The choice of the venue was closely linked to the topic. Close to Pécs one of Europe's largest uranium mines operated between 1958 and 1997. At the end of the last millennium uranium mining practically vanished from Europe due to the enormous break down of the world market price. The closure of the uranium mining and processing sites near Pécs resulted in an enormous economic loss (2000 people lost their job) and an incredible environmental burden for the region.

At the uranium ore processing site near Pécs uranium ore was processed by conventional milling technologies. Uranium ore tailings were deposited in ponds constructed without or with very poor sealing. Process water from these ponds partly seeped through the underground causing a huge chemical contamination of groundwater. Main polluting components were above all magnesium sulphate and sodium chloride.

The remediation of the tailing ponds was urgently needed to solve the stabilisation of the ponds on the one hand and to restore the groundwater quality on the other hand. Different options were chosen to handle the problem: a pump and treat system with an on-site groundwater station, surface stabilisation of the tailing ponds with geo-material, multi layer covering and revegetation and a complex drainage and groundwater containment system. Furthermore, a pilot reactive barrier was installed to prevent the migration of uranium from contaminated groundwater.

Along the course the measures undertaken by Mecsekérc Rt. were comprehensively presented in theory as well as in practice along a one-day excursion.

### **European research on mine water management**

Two research projects of the 5<sup>th</sup> EU Framework Programme for RTD were involved in the organisation of this course:

- € PEREBAR – Long-Term Performance of Permeable Reactive Barriers used for the Remediation of Contaminated Groundwater. The Mecsekérc site functioned as a case study along this research project. The development of a tailored reactive barrier for uranium contaminated groundwater was a central part of the research undertaken.
- € PIRAMID – Passive In Situ Remediation of Acidic Mine and Industrial Drainage. Building on already existing research capacity in this area the key aim of the PIRAMID project was to produce comprehensive engineering guidelines for the passive remediation of acidic and/or metalliferous mine drainage and similar wastewaters.

### **Purpose of the course**

The key purpose of this course was to provide young scientists and engineers with up-to-date information of current research activities in the field of minewater management.

The course was attended by 35 participants from 16 different European countries. The share of women was 35 % and the average age was 31 years. Participants were selected according to selection criteria defined by the project's co-ordination team (i.e. university degree in a thematically related field, added value for current work).

The following report includes review papers of the key-note lectures.

With this course we intended to inspire young scientists and engineers in their future work and to support the strengthening process of the European research community regarding management of soil and groundwater resources.

*Gundula Prokop, IMAGE-TRAIN Co-ordinator  
On behalf of the IMAGE-TRAIN Scientific Co-ordination Team*

## Contents

<b>FOREWORD .....</b>	<b>3</b>
<b>COURSE PROGRAMME .....</b>	<b>6</b>
<b>IMPACTS OF MINING ON PHYSICAL HYDROGEOLOGY</b> P.L. Younger <i>University of Newcastle, UK.....</i>	<b>8</b>
<b>GEOCHEMICAL PROCESSES CONTROLLING MINEWATER POLLUTION</b> D. Banks <i>Holymoore Consultancy, UK.....</i>	<b>17</b>
<b>TRACER INVESTIGATIONS IN FLOODED MINES – THE STRASSBERG/HARZ MULTITRACER TEST</b> Ch. Wolkersdorfer, A. Hasche <i>TU Bergakademie Freiberg, Department of Hydrogeology, Germany .....</i>	<b>46</b>
<b>PASSIVE IN SITU REMEDIATION OF CONTAMINATED GROUNDWATER: PERMEABLE REACTIVE BARRIERS – PRBS</b> K.E. Roehl <i>Karlsruhe University, Germany .....</i>	<b>58</b>
<b>CASE STUDY: REMEDIATION OF A FORMER URANIUM MINING/PROCESSING SITE IN HUNGARY</b> M. Csoevári, Zs. Berta, J. Csicsak, J. Hideg, A. Varhegyi <i>Mecsekerc Rt, Hungary .....</i>	<b>81</b>
<b>WETLAND TREATMENT OF MINE WATERS</b> P.L. Younger <i>University of Newcastle, UK.....</i>	<b>72</b>
<b>MINE WATER REGULATION IN EUROPE: PRELIMINARY FINDING OF THE ERMITE PROJECT</b> J. Loredó <i>University of Oviedo, Spain.....</i>	<b>101</b>
<b>ADDRESS LIST .....</b>	<b>107</b>

## **COURSE PROGRAMME**

2<sup>nd</sup> IMAGE-TRAIN Advanced Study Course, Pécs June 23–27 2003 “Groundwater Management in Mining Areas”

### **Monday June 23**

- 9:00–9:30 Welcome by the host  
*Director Papp, Director of Mecsekérc Környezetvedelmy RT (HU)*
- 9:30–10:00 Introduction to the course  
*Gundula Prokop, IMAGE-TRAIN Co-ordinator, Umweltbundesamt (AT)*
- 10:00–10:30 Self Introduction by course participants
- 10:30–10:45 Coffee Break
- 10:45–12:30 Impacts of mining on physical hydrogeology  
*Paul Younger, University of Newcastle; School of Civil Engineering & Geosciences (UK)*
- 12:30–14:00 Lunch Break
- 14:00–17:00 Practical exercise: Modelling mine water flow (recharge estimation, GRAM algorithm etc)  
*Paul Younger, University of Newcastle; School of Civil Engineering & Geosciences (UK)*

### **Tuesday June 24**

- 9:00–12:00 Tracer investigations in flooded mines  
*Christian Walkersdorfer, Freiberg University of Mining and Technology, Department of Hydrogeology (DE)*
- 12:00–13:30 Lunch Break
- 13:30–17:00 Participants' forum: Presentations by course participants of their own case studies/issues

### **Wednesday June 25**

- 9:00–12:00 Geochemical processes controlling mine water pollution  
*David Banks, David Banks, Holymoor Consulting (UK)*
- 12:00–13:30 Lunch Break
- 13:30–17:00 Practical exercise : Geochemical modelling of mined systems (performance model and PHREEQCi)  
*Paul Younger, University of Newcastle; School of Civil Engineering & Geosciences (UK), David Banks, David Banks, Holymoor Consulting (UK)*

## Thursday June 26

### In situ remediation technologies

- 9:00–10:00 Part 1: Introduction to Permeable Reactive Barrier Systems  
*Karl Ernst Roehl, Karlsruhe University, Department of Applied Geology (DE)*
- 10:00–10:30 Part 2: Overview and types of Wetland Systems  
*Paul Younger, University of Newcastle; School of Civil Engineering & Geosciences (UK)*
- 10:30–10:45 Coffee Break
- 10:45–12:00 Case Study: Remediation of a former uranium mining/processing site (Mecsekérc site)  
*Mihaly Csöväri, Mecsekérc Környezetvedelmy RT (HU)*
- 12:00–19:00 Excursion: Mecsekérc former uranium mining/processing site including Lunch  
*Mihaly Csöväri, Mecsekérc Környezetvedelmy RT (HU)*

## Friday June 27

- 9:00–10:30 Mine water regulation in Europe: preliminary findings of the ERMITE project  
*Jorge Loredó, Oviedo University, Department of Mining (ES)*
- 10:30–10:45 Coffee Break
- 10:45–12:45 Open forum: Towards rational management of groundwater in mining areas  
*Paul Younger, University of Newcastle; School of Civil Engineering & Geosciences (UK)*
- 12:45–13:00 Handover of certificates and official closure of course  
*Gundula Prokop, IMAGE-TRAIN Co-ordinator, Umweltbundesamt (AT)*

## **IMPACTS OF MINING ON PHYSICAL HYDROGEOLOGY**

*P.L. Younger, University of Newcastle, School of Civil Engineering and Geosciences United Kingdom*

*Keywords: Mining, mine waste, impacts, hydrogeology*

### **Introduction**

This paper provides a brief overview of the impacts of mining on physical hydrogeology. For a more comprehensive account, the reader is referred to the recent text book of Younger et al. (2002). In the account which follows, the following topics are examined:

- € The types of mines which exist (deep, surface), their methods of working and the geometry of voids which they produce.
- € Mine wastes: their origins and nature.
- € The implications of the above for physical hydrogeology of mined ground.

### **Types of Mine**

Fundamentally, the mining industry distinguishes between two type of mine:

- (i) Deep Mine: Any mine in which the miner and/or his machinery work beneath a cover of soil or rock (irrespective of absolute depth below ground surface)
- (ii) Surface Mine: Any mine in which the miner and/or his machinery work in an excavated void which is open to the skies

The term “deep mine” is synonymous with “underground mine” or “subterranean mine”.

(In British usage, the unqualified use of the word “mine” generally means a deep mine). Deep mines can be further differentiated into “drift mines” or “shaft mines” depending on the mode of access to the underground workings. Access to deep mines can be either by means of a shaft (i.e. a vertical or sub-vertical tunnel) or an adit (an essentially horizontal or sub-horizontal tunnel from a hillside). In coal-mining districts, the term “drift” is often used synonymously with “adit”, hence the name “drift mine”.

Other types of mine access features represent some form of compromise between horizontal adits or vertical shafts, and these are generally termed “declines”, which refers to inclined tunnels from the ground surface to the workings. (Synonyms for 'decline' include “incline”, “inclined drift”, “slope entry” or (least commonly) “dib”).

### **Working of deep mines**

Working of all deep mines involves the following activities:

- € Development and maintenance of access (for humans, machinery, ancillary services and ventilation)



- ≠ Extraction of as much valuable mineral product as possible.
- ≠ Handling of waste rock

Distinctive arrangements of these activities can be recognised by the patterns of voids shown on mine plans (Figure 1).

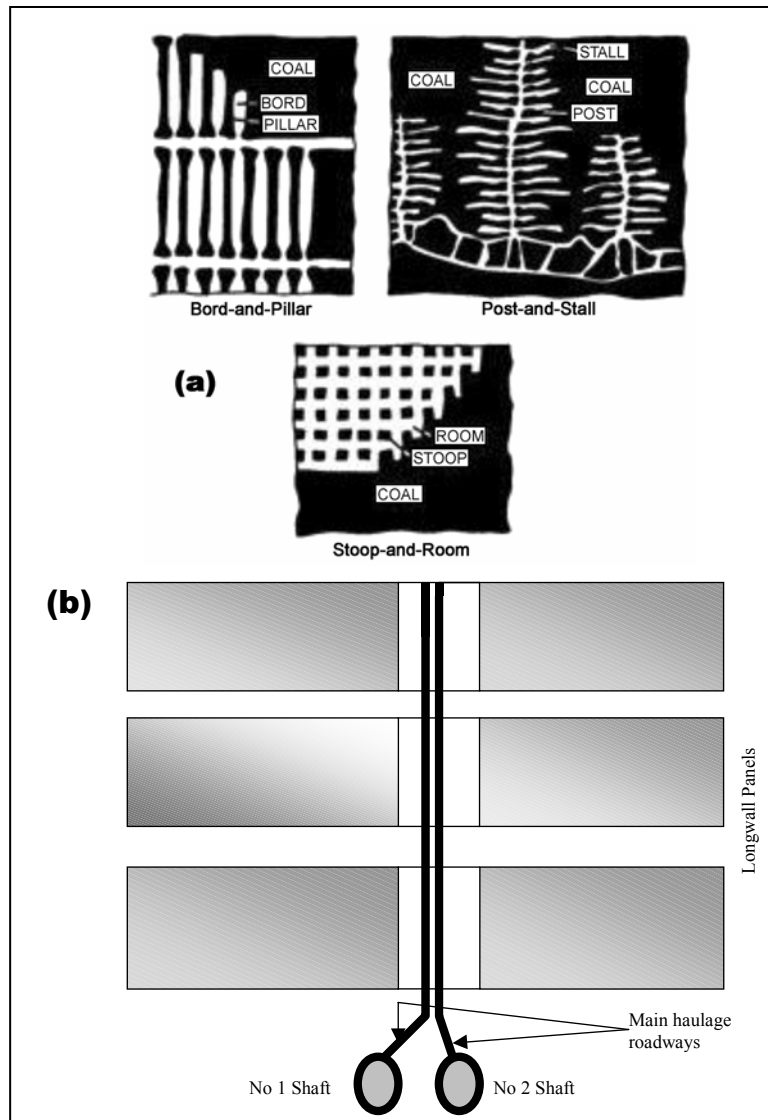

Fig. 1: patterns of underground mine voids associated with (a) various types of "bord-and-pillar" workings and (b) typical longwall workings.

Bord-and-pillar workings (Figure 1(a)) result in approximately rectilinear networks of inter-connecting roadways ("bords") separated by un-mined "pillars" of coal (or other mineral) left behind in order to provide roof support. This manner of workings was the main deep mining technique in Europe for many centuries. Because of the relatively low capital costs of bord-and-pillar working compared to longwall, it remains the principal technique in the USA (where most underground coal mining is undertaken by relatively small companies). It is also practised in situations where:

- ≠ there is a strong need to minimise surface subsidence, or to avoid propagation of roof fractures to overlying aquifers or surface water bodies
- ≠ The worked seam is dipping too steeply for the easy use of longwall techniques.

Typical dimensions of modern bord-and-pillar workings are as follows: bord widths of 6 m to 9 m (larger openings require auxiliary roof support) and “pillar” widths of 9 m–30 m. Pillars will be narrowest where the roof strata are most competent (= least fractured). So-called pillar-robbing (“second working”) of bord-and-pillar workings during retreat is often practised, i.e. removing pillars in part or as a whole in order to improve extraction rates from around 50 % to as much as 90 %. Obviously this greatly increases subsidence in overlying strata so has to be applied only in appropriate situations.

Longwall working (Figure 1(b)) involves the removal of all coal (it is rarely practised as such for other minerals) in entire, discrete 'panels', which may be up to 250 m wide. The “long wall” is the long, working face of such a panel, along which a drum shearer passes back and forth. As the face is cut away, the shearer and its hydraulic supports advance towards the retreating wall, and the area behind the supports is left to fall (forming “goaf”). The longwall is usually sheared away over a distance of 500 m to 1000 m perpendicular to the initial position of the working face. Extraction rates for longwall commonly exceed 90 %, and it is the main technique in modern European coal mining.

“Shortwall” works on the same principle as longwall, but with narrower panels (as narrow as 30m in extreme cases); this is usually done to minimise the vertical extent of subsidence and associated fracturing above the panel, which may be advisable when mining below water bodies.

The term “stopping” refers to a range of techniques applied to deposits with significant vertical extension (e.g. vertical/sub-vertical veins, as in many European metals mines). Varieties of stopping include “stope-and-pillar” (analogous to bord-and-pillar, but in the vertical azimuth), “overhand stopping” (e.g. shrinkage stopping), “block-caving” and “sub-level stopping”. Full details of these techniques are beyond the scope of this paper, and the reader should consult mining engineering texts such as that of Hartman & Mutmansky (2002) for further details.

## Surface Mines

Surface mines currently account for the bulk of world-wide mineral production (> 80 % in the mid-1990s and rising). The term 'surface mine' is approximately synonymous with “open-pit mine”, “quarry”, “opencast mine”, though these terms are also used to signify specific types of surface mines. As in deep mining, there are three Principal activities in surface mining:

- € stripping of overburden (i.e. excavation of non-economic deposits which overlie the ore or coal)
- € mining of the ore or coal
- € restoration and/or other after-use of the mine void

Types of surface mine are distinguished on the basis of how these activities are done, as follows:

- € An open-pit mine (*sensu stricto*) is a surface mine in which the overburden is removed to a disposal area, and the ore is worked from stepped horizontal benches (typically 18–45 m wide) each of which is separated from the subjacent benches by aprons of un-worked rock (9–30 m high, with slope angles in the range 50–70 °)
- € A quarry has slightly different meanings in UK English and US English. In UK usage, virtually all non-coal surface mines will usually be termed a “quarry”, whereas in US usage “quarry” refers specifically to surface mines which produce dimension stone (i.e. well-dressed stone used for ornamental cladding on buildings etc).

- € Open-cast mines (Figure 2) (also known colloquially as “strip mines” in US English) are surface coal mines which resemble open-pit mines, but with one important difference: the stripped overburden is not removed to a disposal area, but is “cast” (i.e. hauled and dumped) directly onto adjacent mined-out panels. Key features of a typical open-cast operation are the walls of un-mined strata (either “side-walls” or the highwall, i.e. the wall of rock which is retreating as it is gradually mined-out) and the “loose-wall”, i.e. the gradually advancing front of tipped overburden immediately behind the current working strip.
- € An auger mine is a technology of limited application which is used to increase the yield of an open-cast site by extracting coal from beneath the highwall by means of horizontal drilling with an auger (essentially a giant corkscrew). As such an auger mine is arguably a “deep mine” operated from the surface!



Fig. 2: Opencast coal mining operations: (left) working bench in front of the highwall of a shallow pit. (right) advancing loose-wall (on left) behind working bench

## Mine Wastes

It is estimated that more than 70 % of all the material excavated in mining operations world-wide is currently waste. In the EU over the last few years, more than 400 Mt of mine waste has been generated per annum, amounting to nearly 30 % of all waste generated in the EU. This is a vast proportion compared to that part of the EU's economy which is currently accounted for by mining.

The reason for the very large volume waste production by mining at present relates to the current preponderance of surface mining. Whereas mature deep mining provides scope to dispose of waste rock within mined voids, and thus produces a tiny proportion (around 1 %) of the total mass of mine waste produced annually around the world, surface mines inevitably disturb vast quantities of overburden. Whilst open-cast mines largely backfill their voids as they go, open-pit mines often don't backfill at all and at the end of mining they leave behind both an open void plus large adjoining waste rock piles.

Mine waste disposal occurs in two principal manners, depending on the origins and grain-size of the wastes:

- € Spoil (i.e. waste rock, or overburden) is generally loose-tipped to form spoil heaps, or else back-filled behind working bench
- € Tailings (i.e. generally fine-grained residues remaining after mineral processing to separate ore from gangue) are typically deposited as a slurry in tailings dams. (Paste disposal is a new option for tailings disposal in certain cases).

## Implications for physical hydrogeology

### How mining alters natural hydrogeology

#### Surface mining

Where surface mines are excavated into aquifer materials, they clearly remove part of the aquifer, which in itself may represent a loss of resource (e.g. increased evaporation from the post-mining pit-lake) or at least an increase in vulnerability for the surrounding aquifer resources (i.e. removal of the barrier to pollutants represented by the unsaturated zone).

Besides these obvious impacts, most other effects of surface mines on natural hydrogeology are rather subtle. A “halo” of increased permeability ( $\Omega$ 100 times greater than background values) can develop around open-pit walls, due to extensional fracturing induced by blasting and the reduction of lateral stresses. Indeed, permeability close to the void may be so high as to favour turbulent flow near the void, resulting in a near-pit water table which is much more steep than would be expected if groundwater flow remained strictly Darcian. This phenomenon has been extensively analysed by Dudgeon (1985), and is also discussed by Younger et al. (2002).

A further impact of pit lakes left behind after cessation of surface mining is that the water table tends to be steeper on the up-gradient side of the pit, and more gentle on the down-gradient side of the pit, than would be the case under natural conditions (Morgan-Jones et al., 1984). On the other hand, although many pit lakes are in hydraulic continuity with the surrounding ground water, in some cases the blinding of the pit floor with fine-grained sediments can effectively “perch” water in the open-pit, with little or no interaction with the surrounding ground water system.

Pit lakes are complex environments from a limnological and geochemical perspective.

Limnologically, the key difference between pit lakes and natural lakes can be quantified by a parameter known as the relative depth ( $D_R$ ) (Castro & Moore, 2000)

$$D_R = 100 (z_m/d)$$

where  $z_m$  is the maximum depth of the lake and  $d$  is some standardised diameter (e.g. for circular lakes,  $d = 2 \sqrt{A/p}$ , where  $A$  is the surface area).

Typical  $D_R$  values for natural lakes are usually  $< 2 \%$ , and few have values of more than  $5 \%$ . By contrast mine pit lake typically have  $D_R$  values in the range  $10$  to  $40 \%$ . Such high values of  $D_R$  have important hydrological consequences. Most notably a high  $D_R$  means that evaporative losses as % of stored water (and therefore evaporative concentration) from the pit lake will be limited compared to a natural lake with a similar surface area. High  $D_R$  also has profound effects on density stratification: with high  $D_R$  values, pit lakes promote the development of three-layer systems in which the third, deepest layer is never involved in seasonal overturn (“meromictic” conditions). For further discussion of the importance of mixing dynamics and coupled geochemical processes for the evolution of pit-lake water quality, the interested reader is referred to the recent, excellent review by *Bowell (2002)*.

#### Deep mining

As a rough 'rule-of-thumb', the caving-in of deep mines can be expected to cause fracturing and subsidence of overlying strata over a vertical distance typically half as high as the void is wide (e.g. a 200 m-wide longwall panel can be expected to affect around 100 m of overlying strata). The volume of rock affected by fracturing and subsidence above longwall panels can be resolved into 3 zones:

- € Zone 1: typically one-third as high as the void is wide: characterised by sagging, extensional fracturing and bed separation permeability increases 60 to 80 times above pre-mining value. (K: 1–20 m/d in Carboniferous Coal Measures in Europe)
- € Zone 2: usually about 25 %–30 % as thick as the underlying Zone 1: net compression, so that permeability remains at or below pre-mining values (K: 0.001–0.1 m/d)
- € Zone 3: Similar in thickness to Zone 2, Zone 3 is an extensional zone, so that permeability again increases (though not by so much as in Zone 1).

For further discussion of these phenomena and their practical implications, the reader should consult the recent comprehensive review of Booth (2002).

The hydrogeology of abandoned deep mines is essentially “non-standard” when compared with natural aquifers. The flow in flooded deep mines is usually highly channelised (i.e. most flow is associated with old mine voids) and very often turbulent (hence Darcy’s Law is inapplicable). Collapse of voids and erosion by turbulent flow can lead to permeability and storativity changes over a scale of days or even hours.

Records of water level rises in shafts accessing abandoned, flooding underground workings are known as “rebound curves”. These typically show staged variations in rebound gradient which are particularly clear on semi-log (“Jacob”) plots. The variations in gradient record vertical variations in storage properties as the water level successively passes through worked and unworked zones (corresponding hydraulically to alternating unconfined and confined storativity conditions).

Modelling of rebound processes has recently been approached using a number of alternative formulations (Adams & Younger, 2001). Essentially, the choice of the most appropriate model is a question of scale, with discrete pipe-network models being most appropriate for detailed analysis of small sub-areas of mine systems, and more coarse semi-distributed models (such as the GRAM model of Sherwood & Younger, 1997) being most appropriate for medium-to-large scale systems of variously inter-connected “ponds” of flooded workings. The use of standard porous medium models may be appropriate at the very largest scales of analysis, especially for rebounded systems where hydraulic gradients are shallow once more. Once an appropriate simulation code has been chosen, the predictive modelling of rebound processes is likely still to be hindered by a number of factors, including:

- € The lack of a tradition of hydrogeological data collection in the mining sector, which means that accurate flow and piezometric data rare
- € Uncertainties in mine plan data
- € The sheer computational expense of simulating all of the relevant details of very large inter-connected systems of mined voids.

Despite these setbacks, successful modelling of rebound processes has been undertaken for a number of major mined systems (e.g. Adams & Younger, 2001), and there is no doubt that further mine closures throughout Europe will necessitate more studies of this type in future (e.g. Younger, 2002).

## Hydrogeology of bodies of mine waste

### Spoil heap creation and hydrogeological properties

The way in which spoil heaps are formed fundamentally influences their internal hydrogeological character. Loose-tipping of poorly-sorted waste rock fragments tends to sort the sediments out into ‘cobbly zones’ (pebbles and cobbles) and fine-grained zones. This imparts profound heterogeneity to the spoil, giving rise to strongly preferential flow mechanisms. Modes of preferential flow differ between the unsaturated and saturated zones in mine spoil heaps:

*Unsaturated zone:* the pore system of the fine-grained fraction of the spoil will always be at or near saturation, whereas pores in cobbly zones will usually be fully drained; hence in the unsaturated zone water moves preferentially through the fine-grained fraction of the sediment.

*Saturated zone:* the cobbly zones are FAR more permeable than the fine-grained zones, so that in the saturated zone, water moves preferentially in cobbly zones.

Preferential flow can in some cases provoke preferential erosion of spoil heaps, leading to development of sinkholes and other features which give rise to surface subsidence (Figure 3a). Surface runoff can be channelled into such features (Figure 3b), further exacerbating erosion and also denying surface environments some much-needed water.

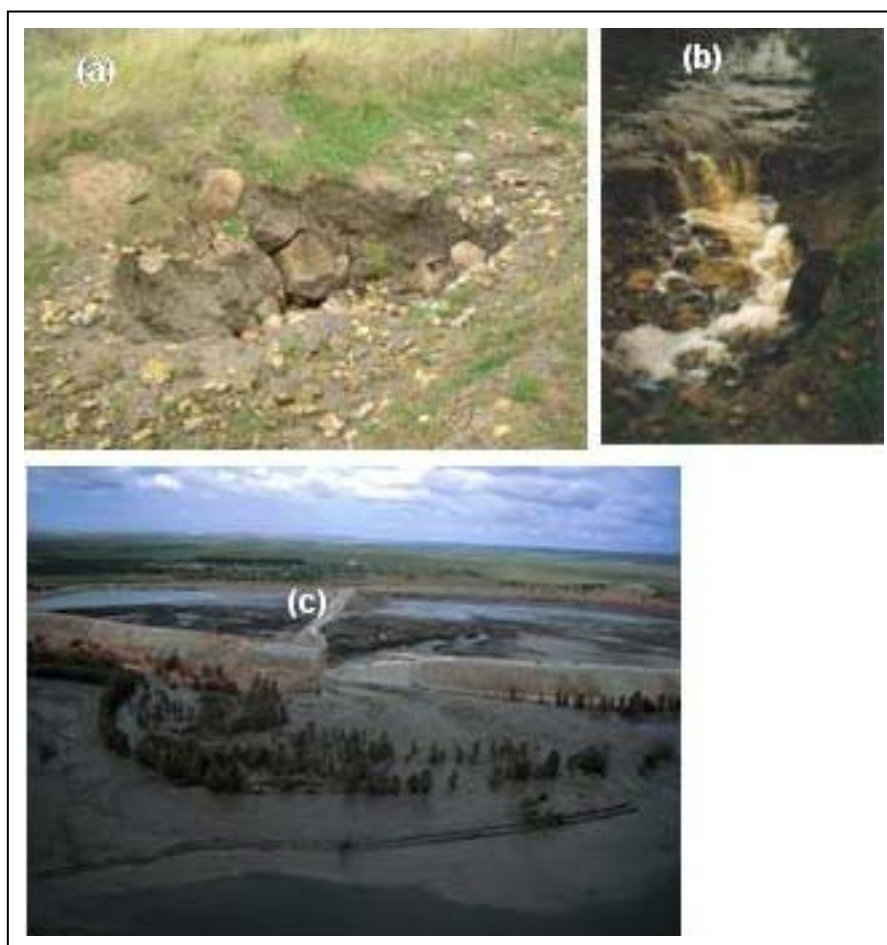

**Fig. 3:** *Geotechnical stability problems associated with the hydrogeological behaviour of waste rock depositories. (a) Subsidence 'crown hole' developed above a preferential subsurface storm-flow pathway in open-cast backfill. (b) The entire flow of a stream disappearing into the same crown hole during a storm. (c) The failure of the Aznalcóllar Tailings Dam in SW Spain in April 1998 – an emblematic event in the recent history of mining environmental management in the EU.*

Depending on the lithology of the waste rock, spoil heaps may be dominated by surface runoff or subsurface flow. For instance, the more shale in the waste rock, the more likely is a spoil heap to give rise predominantly to surface runoff. In areas where much of the waste rock is hard crystalline rock, infiltration and perched groundwater systems are the norm. The relative dominance of surface/subsurface flow has important implications for pollutant-release dynamics:

*Surface runoff-dominated spoil heaps* release their pollutants when heavy rains follow dry spells: peak flows and peak contaminant loads tend to coincide.

*Subsurface-dominated spoil heaps* often have dilution in wet periods, with peak contaminant concentrations during baseflow periods.

This distinction has important implications for remedial design options (Younger et al., 2002).

### Tailings Dams

Tailings are usually deposited from suspension in water. Besides easing physical transport of the tailings, sub-aqueous emplacement also helps prevent pyrite oxidation. However, the mixture of fine-grained sediments and water can give rise to problems with the geotechnical behaviour of tailings dams. In particular, inadequate control of water in tailings and their impounding dams can contribute to rotational/sliding failures which then allow vast volumes of tailings to escape from the tailings dam, as happened at Aznalcóllar, Spain, in April 1998 (Figure 3(b)) and at Baia Mare, Romania, in 1999. Such problems are avoidable, and although the relevant precautions are generally built-in to tailings dam designs, problems tend to arise where later raising of the dam (which might be decades after the initial design, depending on the fortunes of the related mining operation) is implemented in a manner which departs from the original design specifications. Changes in EU laws to prevent this sort of calamity occurring in future are currently very much on the agenda (e.g. European Commission, 2003).

### Conclusions

Mining affects natural hydrogeology quite profoundly, in ways which are often not readily amenable to analysis using conventional methods of groundwater hydrology. Similarly, bodies of mine waste have distinctive hydrological characteristics which complicate their analysis and their geotechnical behaviour. Nevertheless, a conceptual framework now exists by means of which rational hydrogeological analyses in mined areas can be reliably undertaken.

### References

- Adams, R. & Younger, P.L. (2001): A strategy for modeling ground water rebound in abandoned deep mine systems. *Ground Water*, **39**, pp. 249–261.
- Booth, C.J. (2002): The effects of longwall coal mining on overlying aquifers. In Younger, P.L., and Robins, N.S., (eds) *Mine Water Hydrogeology and Geochemistry*. Geological Society, London, Special Publications, **198**, pp. 17–45.
- Bowell, R.J. (2002): The hydrogeochemical dynamics of mine pit lakes. In Younger, P.L., and Robins, N.S., (eds) *Mine Water Hydrogeology and Geochemistry*. Geological Society, London, Special Publications, **198**, pp. 159–185.
- Castro, J.M. & Moore, J.N. (2000): Pit lakes: their characteristics and the potential for their remediation. *Environmental Geology*, **39**, pp. 1254–1260.
- Dudgeon, C.R. (1985): Effects of non-Darcy flow and partial penetration on water levels near open-pit excavations. In: *Proceedings of the 18th Congress of the International Association of Hydrogeologists*, Cambridge, England, September 1985. pp. 122–132.

- European Commission (2003): *Proposal for a Directive of the European Parliament and of the Council on the management of waste from the extractive industries*. Commission of the European Communities, Brussels. COM(2003) 319 final (2.6.2003). 56 pp.
- Hartman, H.L. & Mutmanský, J.M. (2002): *Introductory Mining Engineering*. (Second edition). Wiley, New York. 570 pp.
- Morgan-Jones, M., Bennett, S., & Kinsella, J.V. (1984): The hydrological effects of gravel-winning in an area west of London, United Kingdom. *Ground Water*, **22**, pp. 154–161.
- Sherwood, J.M. & Younger, P.L. (1997): Modelling groundwater rebound after coalfield closure. In Chilton, P.J., et al., (Editors), *Groundwater in the urban environment, Volume 1: Problems, processes and management*. (Proceedings of the XXVII Congress of the International Association of Hydrogeologists, Nottingham, UK, 21–27 September 1997). A.A. Balkema Publishers, Rotterdam. pp. 165–170.
- Younger, P.L. (2002): Coalfield closure and the water environment in Europe. *Transactions of the Institution of Mining and Metallurgy (Section A: Mining Technology)*, **111**, pp. A201–A209.
- Younger, P.L., Banwart, S.A. & Hedin, R.S. (2002): *Mine Water: Hydrology, Pollution, Remediation*. Kluwer Academic Publishers, Dordrecht. (ISBN 1-4020-0137-1). 464 pp.

## Contact

Paul L. Younger  
School of Civil Engineering and Geosciences  
University of Newcastle  
Drummond Building  
UK - NE1 7RU Newcastle upon Tyne  
Phone: + 44 191 222 7942, Fax.: + 44 191 222 6669  
E-mail: p.l.younger@ncl.ac.uk



## **GEOCHEMICAL PROCESSES CONTROLLING MINEWATER POLLUTION**

*D. Banks, Holymoor Consultancy, United Kingdom*

*Keywords: Groundwater, mine water, hydrochemistry, geochemistry, sulphide, coal, acid-base, redox, kinetics*

### **Abstract**

Minewater is a subset of groundwater, subject to broadly similar hydrochemical processes. In “normal” groundwaters, access to oxidising species is poor and acid-base reactions tend to dominate over oxidation reactions. Acid-base reactions such as carbonate dissolution and silicate hydrolysis consume protons and carbon dioxide, and release alkalinity and base cations. In mines, the atmospheric environment is rapidly introduced to the deep reducing geosphere (or *vice versa* in the case of mine waste deposits). This carries the possibility of intense and rapid oxidation of sulphide minerals such as pyrite, to such an extent that these acid-generating redox reactions may dominate over acid-base “neutralisation” reactions and result in the phenomenon of “acid rock drainage” (ARD). In ARD, a negative correlation is typically observed between pH and concentrations of many metals and metalloids, base cations and sulphate. This correlation is due to (i) genetic co-variation – generation of protons, sulphate and metals in sulphide weathering reactions, (ii) pH-dependent solubility of many ARD-related metals and (iii) low pH intensifying carbonate dissolution and silicate hydrolysis to release aluminium, silica and base cations. This paper examines the reactions involved in ARD generation and neutralisation, and attempts to clarify key concepts such as pH, Eh, alkalinity, acidity and equilibrium constants.

### **PART 1: AN OVERVIEW**

#### **Introduction**

Groundwater is often defined as water occurring within the subsurface geological environment. Mine water is thus merely a type of groundwater, subject to the same geochemical processes as “normal” groundwater. Mine water often appears very different to the pure spring water beloved of poets and bottled water manufacturers, however: it may be highly acidic, brightly coloured and packed full of salts and potentially toxic metals. So what is it that creates the difference between our flask of Evian and our sampling bottle of mine water from San José silver/tin mine? Why are some mine waters alkaline (Banks et al., 2002b), while others are acidic and rich in aluminium, iron and other metals (Banks, 1994)? This paper attempts to provide an introduction to some of the answers. We should start, however, by examining, in outline, some of the processes which give all groundwaters (including mine waters) their characteristic chemical signatures.

## The Hydrochemistry of Groundwater

Every groundwater has its own unique hydrochemical fingerprint. This is derived from the interplay of various processes at various stages along the groundwater's flow path:

### Recharge Chemistry

Groundwater may retain some of the characteristics of the water (rainfall, snowmelt or infiltrating river water) that was the source of its recharge. For example, newly recharged groundwater will often contain:

- ∓ An isotopic signature ( $^2\text{H}$ ,  $^3\text{H}$ ,  $^{18}\text{O}$ ) characteristic of the rainfall at the geographic location, time and altitude of recharge
- ∓ An "atmospheric" chloride content, which may increase with decreasing distance from the coast (due to marine aerosols in the atmosphere, Banks et al. 1998).
- ∓ A content of atmospheric "pollutants" from industry or motors: nitrate, sulphate, chloride
- ∓ A high content of dissolved oxygen

### Soil Zone

The soil zone is a highly microbiologically active environment. Respiration within the soil zone produces  $\text{CO}_2$ . Thus, groundwater leaving the soil zone will often be charged with high concentrations of dissolved  $\text{CO}_2$  (with an isotopic  $^{13}\text{C}$  signature reflecting soil zone processes).

### Water-Rock Interaction

This innocent term covers a huge range of geochemical processes that describe various ways in which groundwater reacts with minerals in the subsurface. The most important of these will be discussed in the next section. In general, water-rock interaction processes in "normal" groundwater tend to result in:

- ∓ Consumption of dissolved  $\text{O}_2$  and  $\text{CO}_2$
- ∓ Elevation of pH and production of alkalinity
- ∓ Release of base cations

### Mixing

Along its flow path, groundwater may mix with other water "facies", e.g.

- ∓ Mixing with deep saline "formation" water within the aquifer
- ∓ Mixing with intruding saline water from a surficial source (e.g. sea water)

## Water-Rock Interaction

The main reactions taking place between water and mineral phases in the subsurface fall into four main categories:

### Dissolution Reactions

E.g. halite:  $\text{NaCl} \leftrightarrow \text{Na}^+ + \text{Cl}^-$

or fluorite:  $\text{CaF}_2 \leftrightarrow \text{Ca}^{2+} + 2\text{F}^-$

### Ion Exchange Reactions

These often take place on the surface of minerals such as clays:

e.g.  $\text{Ca-clay} + 2\text{Na}^+ \leftrightarrow \text{Na}_2\text{-clay} + \text{Ca}^{2+}$

### Acid-Base Reactions

The most common rock-forming minerals (carbonates, silicates) are bases that consume protons (acid) on reacting with groundwater. Note that dissolved carbon dioxide is regarded as an acid, as it dissociates to release protons:

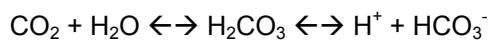

Examples of acid base reactions include the weathering of calcite or plagioclase feldspar:

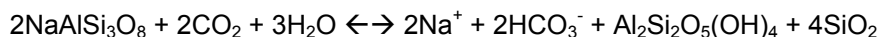

Note that these reactions tend to:

- ≠ consume  $\text{CO}_2$  and elevate pH
- ≠ release bicarbonate alkalinity
- ≠ release base cations

In most “normal” groundwaters, these types of reactions dominate, resulting in groundwaters of neutral to slightly alkaline pH (Frengstad & Banks, 2000), dominated by base cations ( $\text{Ca}^{2+}$ ,  $\text{Mg}^{2+}$ ,  $\text{Na}^+$ ) and bicarbonate.

### Redox Reactions

Here, electrons are transferred between reacting species, causing *oxidation states* to be altered. For example, the oxidation of organic matter:

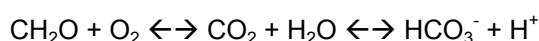

Oxidation reactions often (but not inevitably) release acid. Reduction reactions often consume acid and release alkalinity. For example, the (bacterially catalysed) oxidation of pyrite releases protons (acid):

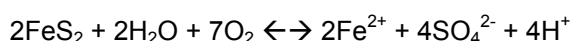

## What is so Special About Mine Water ?

The earth's immediate subsurface is a reaction front between the atmosphere (generally oxidising and acidic) and the geosphere (generally reducing and basic). Groundwater is the circulating medium which carries atmospheric reactants (oxygen, carbon dioxide) into the geosphere. The zone of groundwater circulation is typically the zone where redox and acid-base reactions occur.

In normal groundwater environments, the contents of oxidisable minerals (e.g. pyrite) are so low or the access to oxidising species (e.g. oxygen) is so poor, that acid-base reactions (which consume protons) dominate over redox oxidation reactions (which may generate protons). Thus, "normal" groundwaters have typically neutral to slightly alkaline pH (Frengstad & Banks, 2000), dominated by base cations ( $\text{Ca}^{++}$ ,  $\text{Mg}^{++}$ ,  $\text{Na}^+$ ) and bicarbonate.

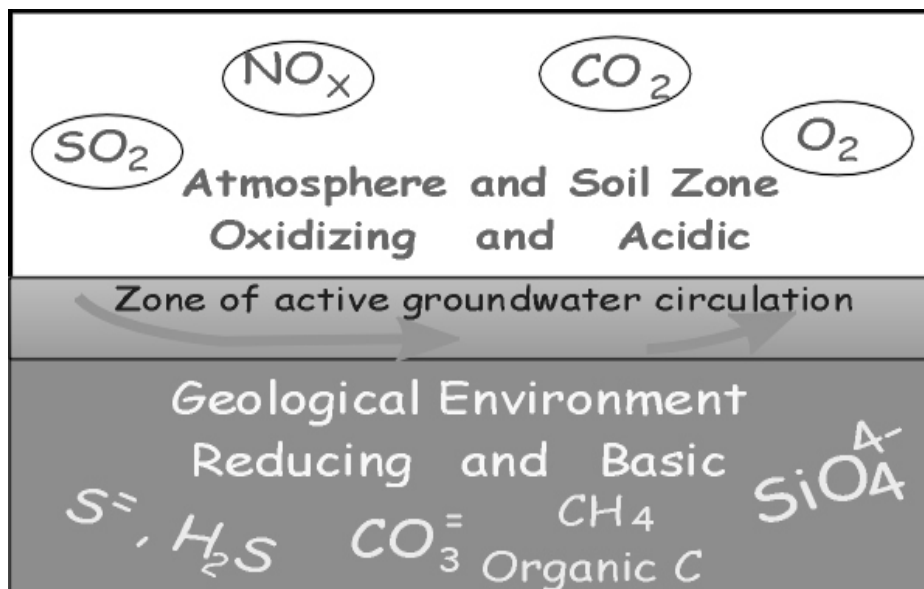
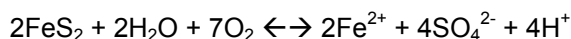

Fig. 1: The zone of groundwater circulation is a reaction front between the oxidising, acidic atmosphere and the reducing, basic geosphere. The zone of groundwater circulation is characterised by acid-base and redox reactions. The rate of reaction will increase where flaws in the geosphere (e.g. mines) allow rapid circulation of water and oxygen, or where geosphere material is transported directly to the surface environment (mine waste tips).

When we dig mines, we introduce the rapid circulation of oxygen and water into the deep geosphere, in zones where there are high concentrations of oxidisable minerals (sulphides). Similarly, when we create mine waste tips, we are bringing deep sulphide-rich geosphere up into the atmosphere, with often excellent access to circulating water and oxygen. Thus, *in mine or spoil tip environments, oxidation reactions may dominate over acid-base (neutralization) reactions, resulting in the phenomenon of **acid rock drainage (ARD)**.*

Thus, where sulphide oxidation is the dominant reaction:



mine waters may be dominated by:

- € Low pH
- € Elevated sulphate concentrations
- € Elevated concentrations of metals

It should here be noted that not all sulphide minerals release protons on oxidation:

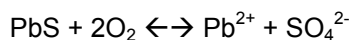
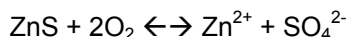

However, if pyrite/marcasite is also present, the acidic environment generated will assist in mobilising other metals such as Zn and Pb, whose solubility is pH-dependent.

## Characteristics of Mine Waters

Tables 1 and 2 present analytical characteristics of various mine waters from metal sulphide mines (Table 1) and coal mines (Table 2). Table 3 shows leachates from selected mine waste tips. From the Tables, the following points should be noted:

- € There is considerable variation in mine water chemistry, even amongst mines of the same type. This can be ascribed to factors such as: access to and rate of circulation of water and oxygen, neutralisation potential of host rocks and ambient groundwater, morphology and mineral content of sulphide minerals, age of mine discharge. Particularly aggressive (i.e. metal-rich, acidic) mine waters would thus be expected where:
  - o Mines or spoils have a high pyrite content, especially if fine-grained
  - o Mines or spoils have good access to oxygen (i.e. unflooded mines)
  - o Water throughput is low. Lack of dilution may produce very aggressive mine waters (e.g. San José)
  - o Recent flooding of a mine has resulted in a “first flush” of accumulated pyrite weathering products from a mine
- € Metals mines generally have the potential to generate more aggressive mine waters than coal mines.
- € The most aggressive discharges emanate from recently flooded (or, sometimes, pumping) mines.
- € As pH and alkalinity increase, contents of metals, sulphate and base cations generally decrease. This is due to several factors:
  - o Metals, protons and sulphate are all released upon sulphide weathering. A co-variation in these parameters would thus be expected
  - o Low pH promotes hydrolysis of carbonates and silicates, thus releasing base cations to the water
  - o Low pH promotes solubility and mobilisation of most heavy metals (including Fe, Zn, Cu, Al, Pb etc.)
- € Chloride concentrations are independent of pH.

The final water in Table 3 is from natural landslipped, broken strata (pyritiferous Millstone Grit shales) at Mam Tor mountain, Derbyshire, UK. This demonstrates that “acid rock drainage” can have a purely natural origin (Vear & Curtis, 1981, Banks, 1997, Banks et al., 1997a).

Tab. 1: Hydrochemical characteristics of three different metal sulphide mine waters:

Mine	San José Bolivia	Kongens Gruve Norway	Magpie Sough UK
Flow rate (l/s)	8	5.8 (average)	-
Temperature (°C)	20.8	n/a	n/a
pH	1.47	2.7	7.2
Alkalinity (meq/l)	0	0	4.28
Cl <sup>-</sup> (mg/l)	32670	n/a	19
SO <sub>4</sub> <sup>2-</sup> (mg/l)	8477	901	33
Ca <sup>2+</sup> (mg/l)	1780	47.8	98
Na <sup>+</sup> (mg/l)	17256	n/a	8
Fe (mg/l)	2460	134	<0.0005
Al (mg/l)	559	33.1	0.005
Mn (mg/l)	27.4	n/a	<0.0002
Zn (mg/l)	79.4	36.3	0.074

*San José., Bolivia: a pumped discharge from a tin/silver polymetallic sulphide mine (Banks et al., 2002a).*

*Kongens Gruve, Norway: gravity discharge from an abandoned a Cu/Zn massive sulphide mine (Iversen & Knudsen, 1997).*

*Magpie Mine, UK: old gravity discharge from a PbS/barite/fluorite deposit hosted in limestone (Edmunds et al., 1989, Banks et al., 1996).*

Tab. 2: Hydrochemical characteristics of four different coal mine waters:

Mine	Ynysarwed Wales	Dunston Chesterfield, UK	Morlais Wales	Mine No. 3 Svalbard
Flow rate (l/s)	15–35	c. 20	c. 100–200	c. 0.056
Temp. (°C)	-	9.4	14.2	4.7
pH	4.2	6.3	6.9	8.2
Alkalinity (meq/l)	2.76	3.74	6.07	36
Cl <sup>-</sup> (mg/l)	32	26	25	236
SO <sub>4</sub> <sup>2-</sup> (mg/l)	1554	210	455	7.43
Ca <sup>2+</sup> (mg/l)	222	64.5	91.8	15.5
Na <sup>+</sup> (mg/l)	109	51.4	155	925
Fe (mg/l)	180	10.6	26.6	<0.01
Al (mg/l)	<0.5	<0.045	<0.01	<0.02
Mn (mg/l)	6.1	1.26	0.93	0.004
Zn (mg/l)	0.061	<0.007	<0.002	0.055

*Ynysarwed (new discharge, unpublished analytical data, sampled 15/9/94), Carboniferous Coal Measures of South Wales.*

*Dunston (historic discharge, Banks et al. 1997a), Carboniferous Coal Measures of UK East Midlands*

*Morlais (c. 20 year-old discharge, Banks et al. in prep), Carboniferous Coal Measures of South Wales*

*The Svalbard mine water is a pumped discharge from the active Mine No. 3, Bjørndalen, near Longyearbyen, Svalbard, in Tertiary strata (Banks et al., 2002b).*

Tab. 3: Three leachates from mine waste tips, and one leachate from natural landslipped pyritiferous strata (Mam Tor).

Mine	Løkken Norway	Sverdrupbyen Svalbard	Orgreave Yorkshire, UK	Mam Tor Derbyshire, UK
Flow rate (l/s)	0.84	c. 0.25	c. 0.033	c. 0.8
Temp. (°C)	-	1.9	-	3.4
pH	2.11	2.7	7.4	3.08
Alkalinity (meq/l)	0	0	4.72	0
Cl <sup>-</sup> (mg/l)	-	7.0	625	7.9
SO <sub>4</sub> <sup>2-</sup> (mg/l)	17036	1077	2370	1480
Ca <sup>2+</sup> (mg/l)	330	48.2	136	197
Na <sup>+</sup> (mg/l)	n/a	18.0	947	6.8
Fe (mg/l)	4720	179	0.27	27.3
Al (mg/l)	580	27.5	<0.022	51.3
Mn (mg/l)	n/a	3.2	0.33	23.9
Zn (mg/l)	87.4	1.3	0.059	1.04

Løkken, Norway. Mine waste from a Cu/Zn mine in a massive sulphide ore (Arnesen et al., 1994).

Svalbard. Coal mine spoil tip, Sverdrupbyen, Longyearbyen. Tertiary coals (Banks et al., 2002b).

Orgreave, near Sheffield, UK. Coal mine spoil from a deep Carboniferous Coal Measures mine. The formation water is saline and alkaline and has not yet been fully flushed from the mine waste (Banks et al., 1997a).

## The “First Flush” Phenomenon

While a mine is worked and dewatered by pumping, sulphide oxidation proceeds in dewatered strata. Intermediate oxidation products (sulphate and hydroxysulphate minerals) accumulate in these unsaturated strata.

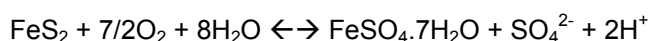

Examples of these intermediate products include:

∄ Melanterite:  $\text{Fe}^{\text{II}}\text{SO}_4 \cdot 7\text{H}_2\text{O}$

∄ Jarosite:  $\text{HFe}^{\text{III}}_3(\text{SO}_4)_2 \cdot (\text{OH})_6$ ,  $\text{NaFe}_3(\text{SO}_4)_2 \cdot (\text{OH})_6$

∄ Coquimbite:  $\text{Fe}^{\text{III}}_2(\text{SO}_4)_3 \cdot 9\text{H}_2\text{O}$

∄ Alunite:  $\text{KAl}_3(\text{SO}_4)_2 \cdot (\text{OH})_6$

∄ Jurbanite:  $\text{AlSO}_4\text{OH} \cdot 5\text{H}_2\text{O}$

These secondary products may form stalactites, stalagmites, efflorescences and growths in abandoned mines, as was observed in the San José mine in Oruro, Bolivia (Banks et al., 2002a).

When the mine closes and floods, rising mine water levels dissolve and mobilise all these accumulated secondary products and acidic pore waters, resulting in a highly potent “first flush” of concentrated mine water.

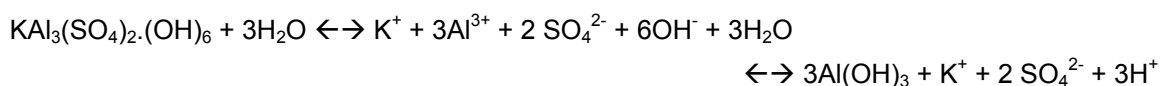

With time, the high initial acidity and metal concentrations of the first flush decay. The concentrations often seem to follow a quasi-exponential decay curve, indicative of flushing out of accumulated oxidation products (“*vestigial*” acidity/contaminant loading) from the mine system with fresh recharge water. The concentrations tend, in the long term, towards a steady state contaminant loading that reflects new, ongoing (“*juvenile*”) acidity production from pyrite weathering.

Figure 2 shows the decay of “first flush” concentrations following the overflow of Wheal Jane tin mine in Cornwall. In fact, Younger (2000) and Younger et al. (2002) have studied empirical data and found that the time taken for exponential decay flushing ( $t_f$ ) can be related to the time taken for the mine to fill with mine water following cessation of pumping ( $t_r$ ). In other words, the rate of decay is related to the floodable mine volume, as one would expect in a flushing model. Younger (2000) and Younger et al. (2002) found that  $t_f$  is approximately equal to four times  $t_r$  (Figure 3).

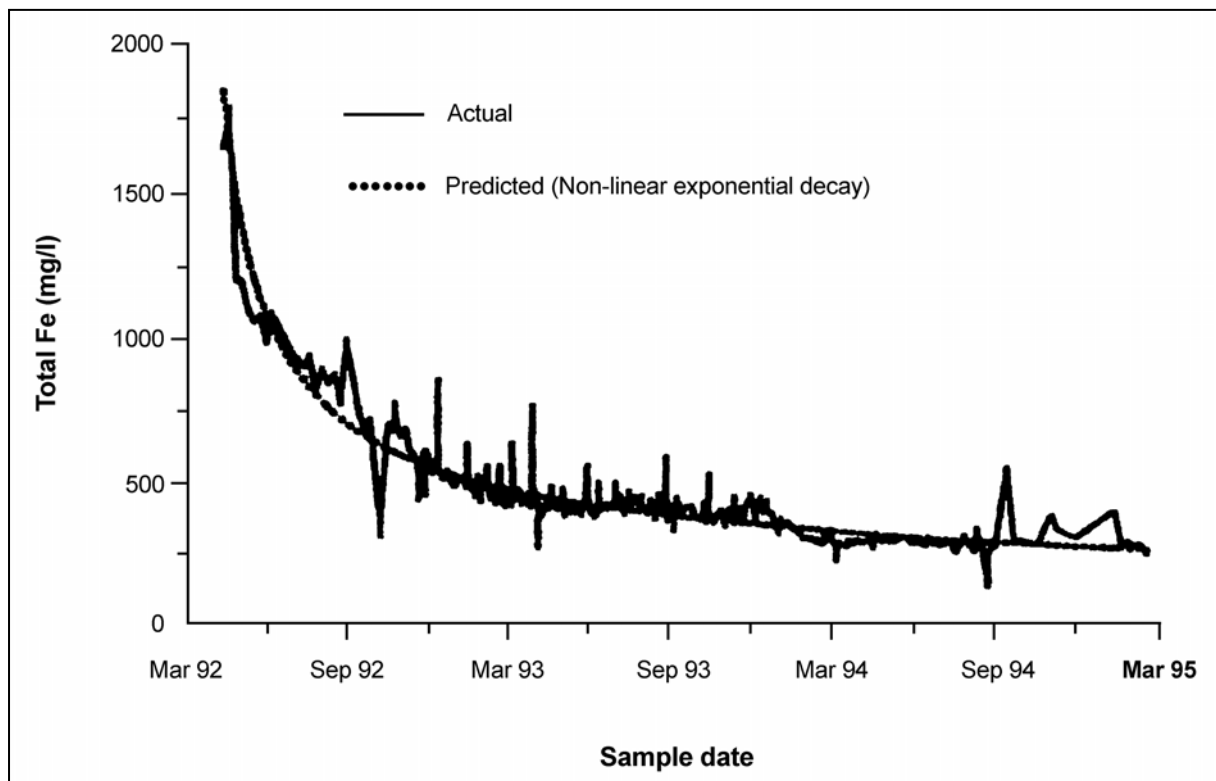

Fig. 2: Evolution of contaminant loading from Wheal Jane tin mine, following its overflow in 1992. Note the exponential decay of “first flush” concentrations towards a steady state (after Younger et al., 2002).



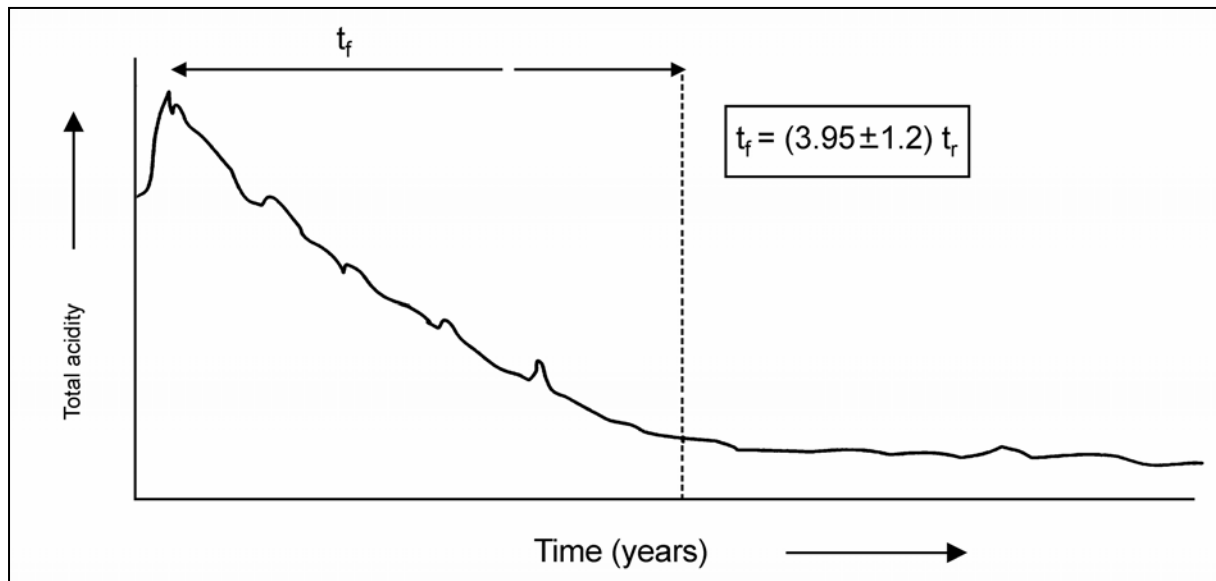

Fig. 3: Time taken for decay of “first flush” concentrations to a steady state condition (after Younger et al., 2002).

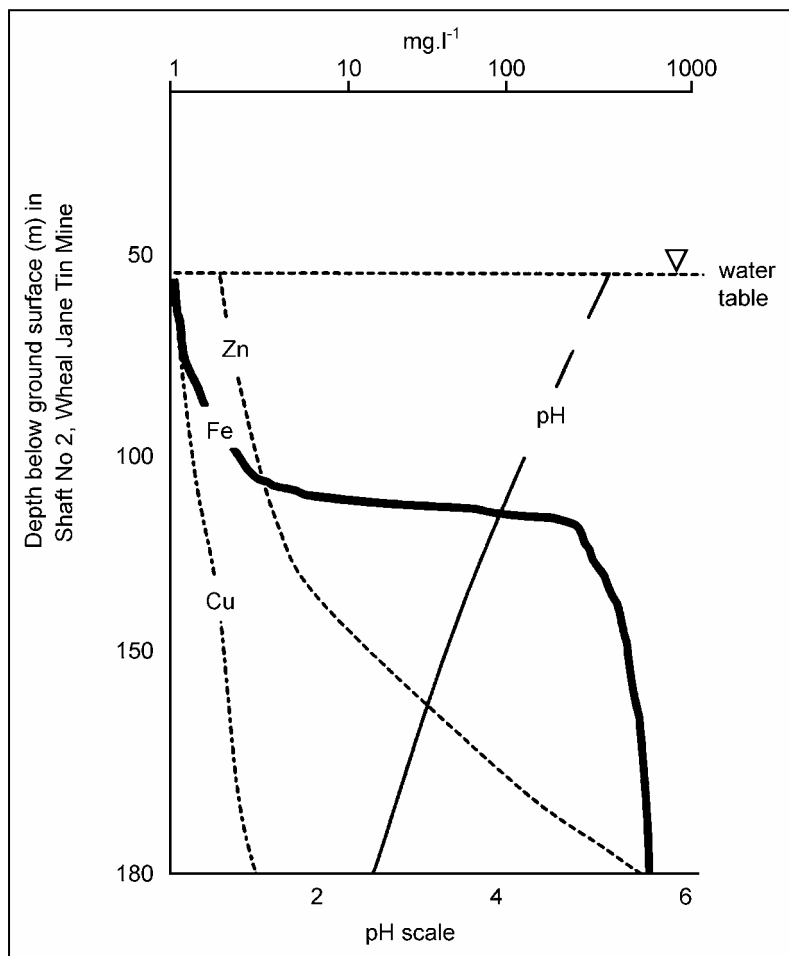

Fig. 4: Stratification of chemistry during flooding within Wheal Jane tin mine, Cornwall (after Younger et al., 2002). Note that such stratification may be destroyed by turbulence once the mine overflows or is pumped (Nuttall et al., 2002).

It should be remembered, however, that the volume being actively flushed *may* not be the total volume of the mine. Some mine systems develop a stratification (see Figure 4), where only the upper portion of the mine is being actively flushed, and the lower part contains “stagnant”, highly contaminated mine water.

### Can We Predict the Quality of Mine Drainage Water

Well, no, not really. There are usually too many unknown variables. We can, however, make some general observations.

1. Acidic, contaminant-loaded mine waters are characteristic of mine systems which are unsaturated, with rapid throughflow of water and good access for oxygen, e.g. workings from surface outcrops, which may be under-drained by a sough or adit (Figure 5a).
2. Flooded workings (especially coal mines), with poor access for oxygen and slow water throughflow, are often characterised by more circum-neutral mine waters (Figure 5b).
3. Some researchers have found tentative correlations between coal mine water iron concentrations and (a) stratigraphical proximity to marine beds in the UK Carboniferous Coal Measures (characterised by high sulphur contents) and (b) distance to outcrop of most closely associated coal seam (MCACS) – Figure 6.

Younger (2000), having studied some 81 UK coal mine discharges concluded that:

- € If the worked seam was within 25 m (stratigraphically) of a marine bed, peak first-flush concentrations in excess of 100 mg/l Fe could be expected, Otherwise, concentrations not exceeding some 10s of mg/l are likely
- € For coal mines >0.5 km from the outcrop of the shallowest worked seam, long term Fe concentrations of around 7  $\pm$  1.6 mg/l were typical. If <0.5 km, an Fe concentration of 19  $\pm$  2.9 mg/l was regarded as characteristic.
- € Fe concentrations could be related to the sulphur content of the worked seam, if known (Table 4)

Tab. 4: Fe concentrations ( $\pm$  standard error at 95 % confidence level) for worked coal seams of differing sulphur content, based on 81 British coal mine discharges (after Younger, 2000)

S content of worked seam	“First flush” peak concentration of Fe, mg/l	Long term, post-flush concentration of Fe, mg/l (for discharges < 0.5 km from outcrop of shallowest seam)
< 1 wt %	0.15 $\pm$ 0.27	0.018 $\pm$ 0.76
1–2 wt %	98 $\pm$ 14	12 $\pm$ 8
2–3 wt %	267 $\pm$ 40	33.8 $\pm$ 22
3–4 wt %	873 $\pm$ 163	110 $\pm$ 78
4–5 wt %	1494 $\pm$ 248	190 $\pm$ 127

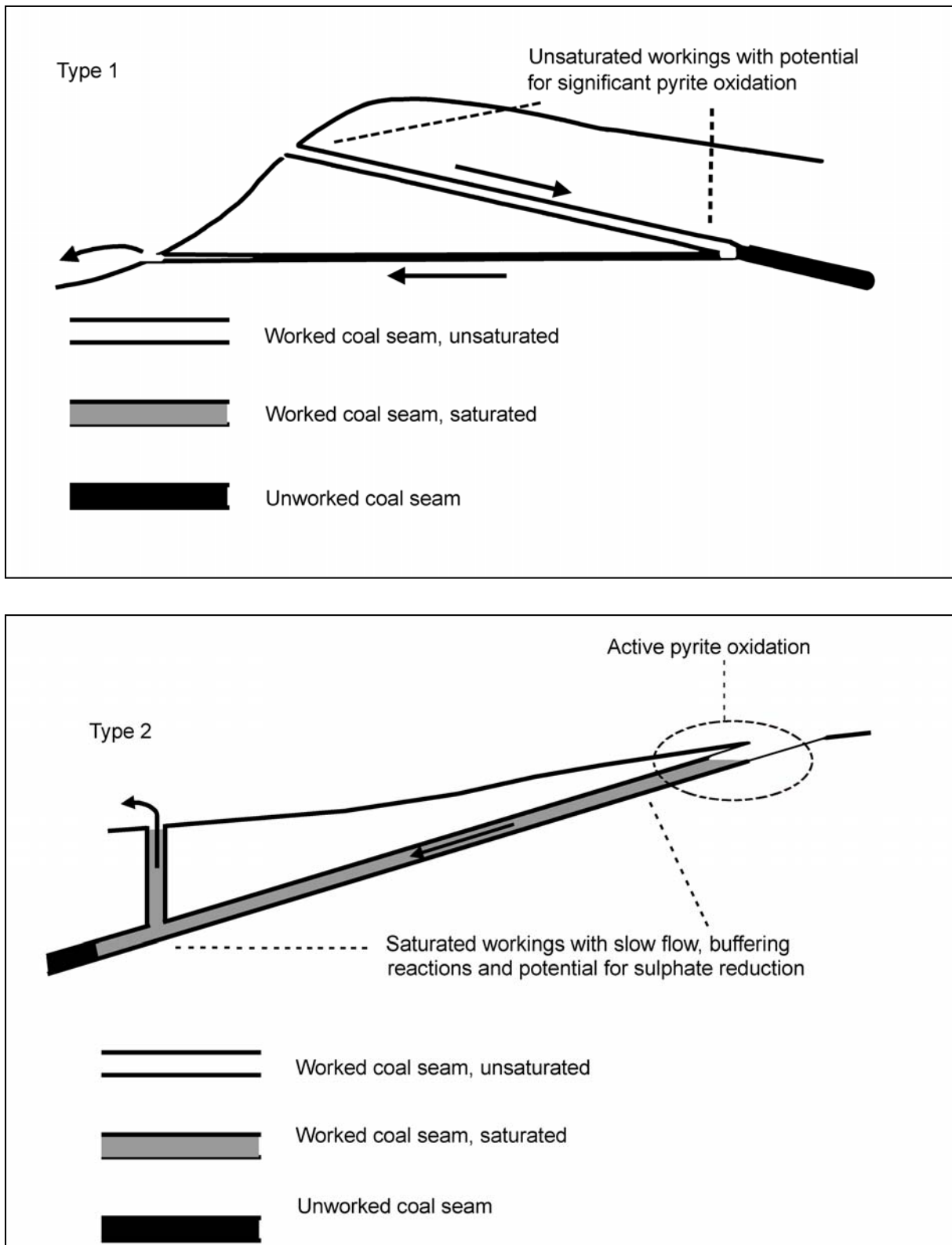

Fig. 5: Coal mine workings which characteristically produce (a) net acidic, aggressive mine waters are derived from unsaturated, under-drained workings. Those (b) producing more circum-neutral, net alkaline waters, are typically from flooded mine systems (after Banks et al., 1997).

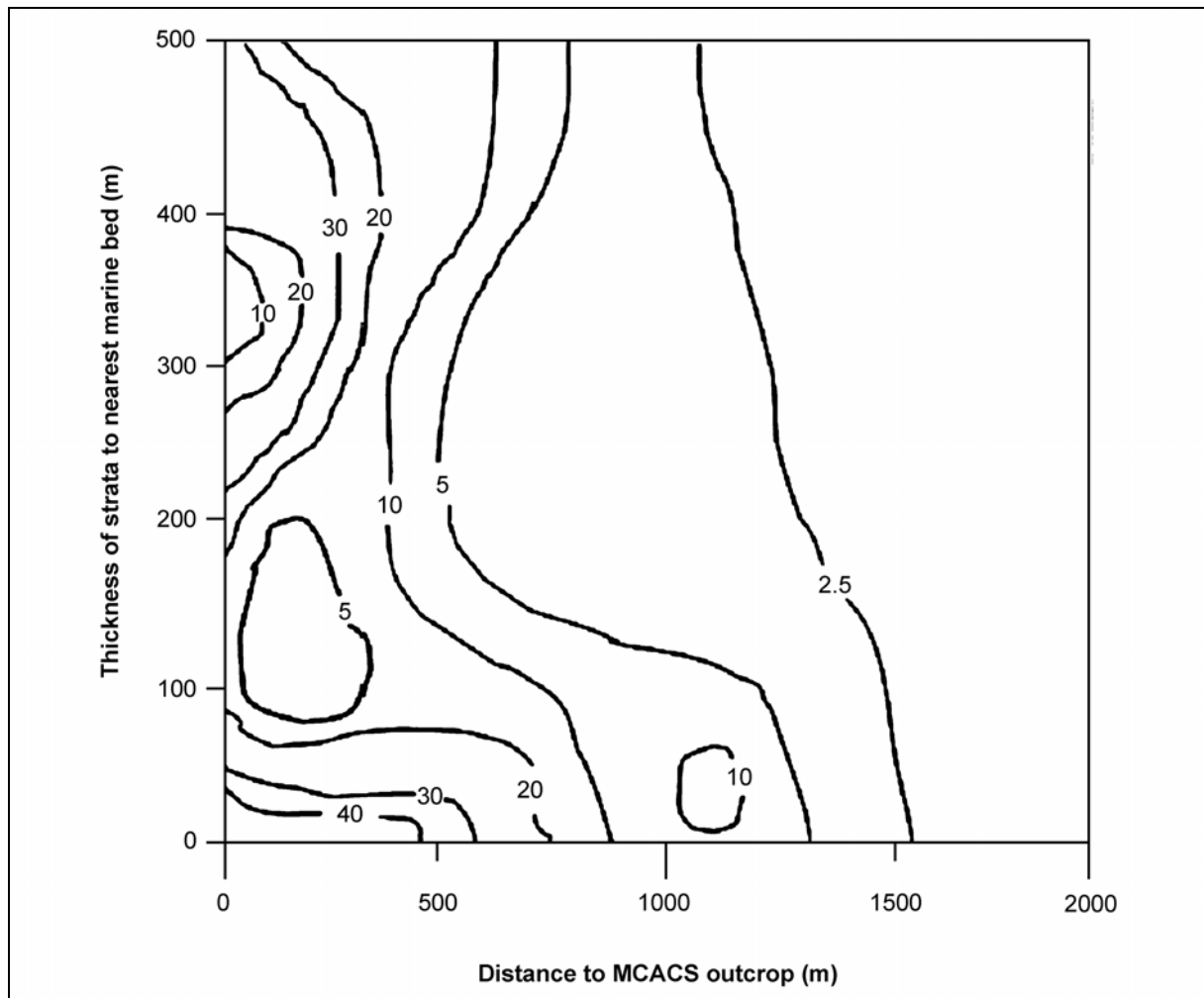
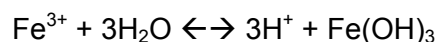
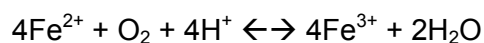

Fig. 6: Contours of total iron (mg/l) in UK mine-water discharges after completion of the main period of flushing, as a function of both stratal thickness to the nearest marine bed and the distance to MCACS (Most Closely Associated Coal Seam) outcrop (after Younger, 2000).

### Precipitation of Ochre and Other Minerals in Recipient Watercourses

When minewater emerges from a mine, increased access to oxygen and possible increase in pH on mixing with recipient waters, may cause oxidation, hydrolysis and precipitation of metal oxyhydroxides or other salts. For example, ferrous iron may oxidise and precipitate as an orange ferric oxyhydroxide ("ochre"), which may be written as  $\text{Fe}(\text{OH})_3$  or  $\text{FeOOH}$ :



The combined reaction is thus:

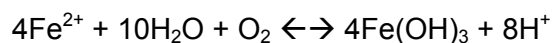

The overall ochre precipitation reaction is thus proton-generating. It is thus potentially self-limiting: generation of protons may lower the pH to a point where ferric ions no longer precipitate as a hydroxide, *unless* adequate neutralisation capacity (i.e. alkalinity) is present in the water. Similarly, dissolved aluminium may precipitate as a white hydroxide

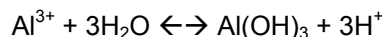

However, aluminium is only soluble in the most acidic mine waters. Thus, precipitates from acidic mine waters tend to contain aluminium hydroxide and may be whiter or yellower in colour than those precipitating from more circum-neutral mine waters, which are typically more red-dish-orange in coloration.

Many other minerals may be found in stream bed precipitates. In very aggressive mine waters, (for example, San José, see Table 1) both calcium and sulphate concentrations may be high, leading to precipitation of gypsum:

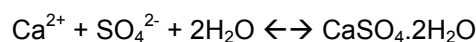

## PART 2: CHEMICAL FUNDAMENTALS

### Master Variable: pH

pH is a measure of the activity of hydronium (hydrogen) ions (protons) in solution

$$\text{pH} = -\log_{10}(\text{H}^+)$$

where () denotes activity in mol/dm<sup>3</sup> or mol/l. Thus, in water of pH=7, the activity of hydrogen ions is 10<sup>-7</sup> mole/l or 0.0001 mg/l. In water of pH = 3, the activity is 10<sup>-3</sup> mole/l hydrogen ions or 1 mg/l.

pH is often described as a “*master variable*” because it controls much of the hydrochemistry of a water sample, and the mineralogical reactions which it can undergo. For example, it controls the solubility of metal ions such as Al, Fe and Zn (Figures 7a,b,c). In these concentration vs. pH diagrams, the solid lines show the concentrations of a variety of metal hydroxide species in the water at a given pH value, while the dashed line shows the total solubility of the metal in water. It will be noted that Al is highly insoluble in water at pH values between 5 and 8 (typical groundwater pH). In acidic and alkaline waters, however, the solubility begins to become significant (i.e. >10<sup>-6</sup> M).

Ferric iron, in contrast, is practically insoluble (<10<sup>-6</sup> M) at all pH values greater than around 3–4, a fact which has great importance when treating mine waters. Zinc is, however, more soluble, and its minimum solubility is only reached at appreciably higher pH values than Al and Fe, namely around pH 9–10. This partially explains why Zn is so difficult to remove from mine waters by simple pH adjustment techniques.

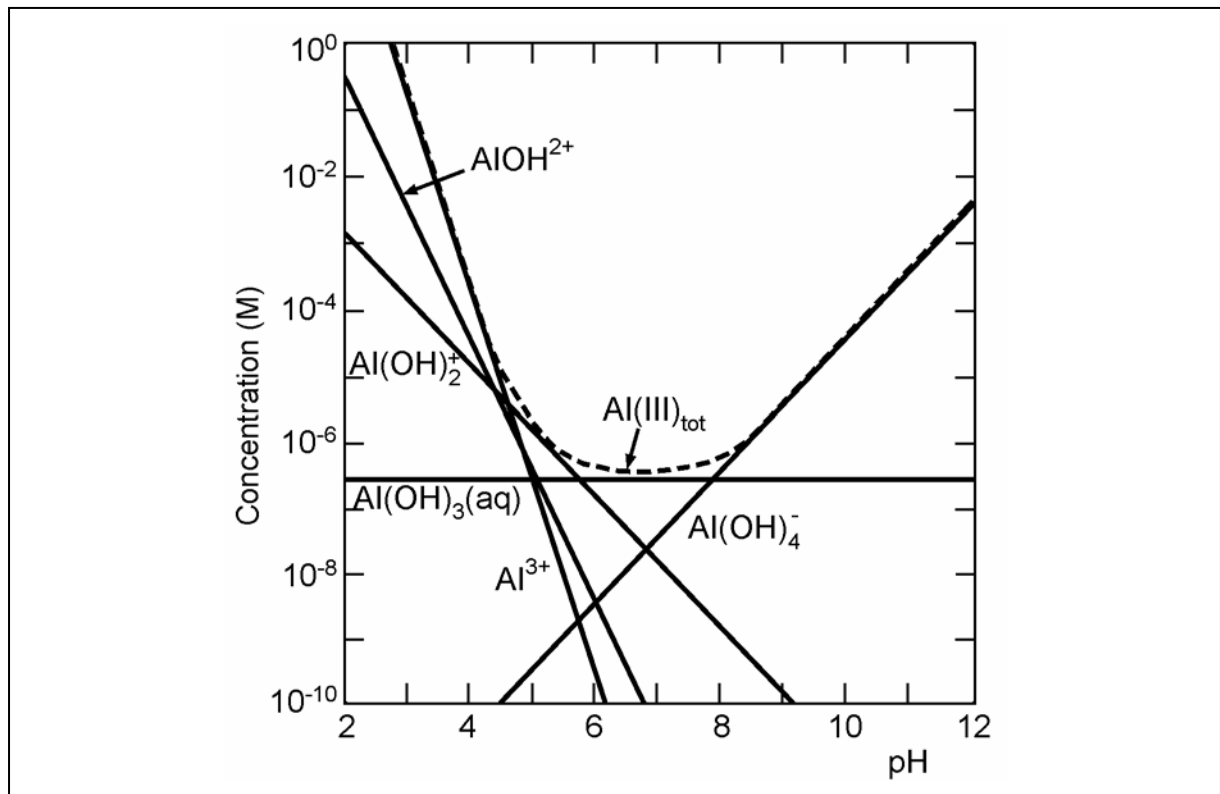

Fig. 7a: pH dependence of solubility of aluminium hydroxide species in water. The dashed line represents total Al solubility (after Stumm & Morgan, 1996 and Younger et al., 2002).

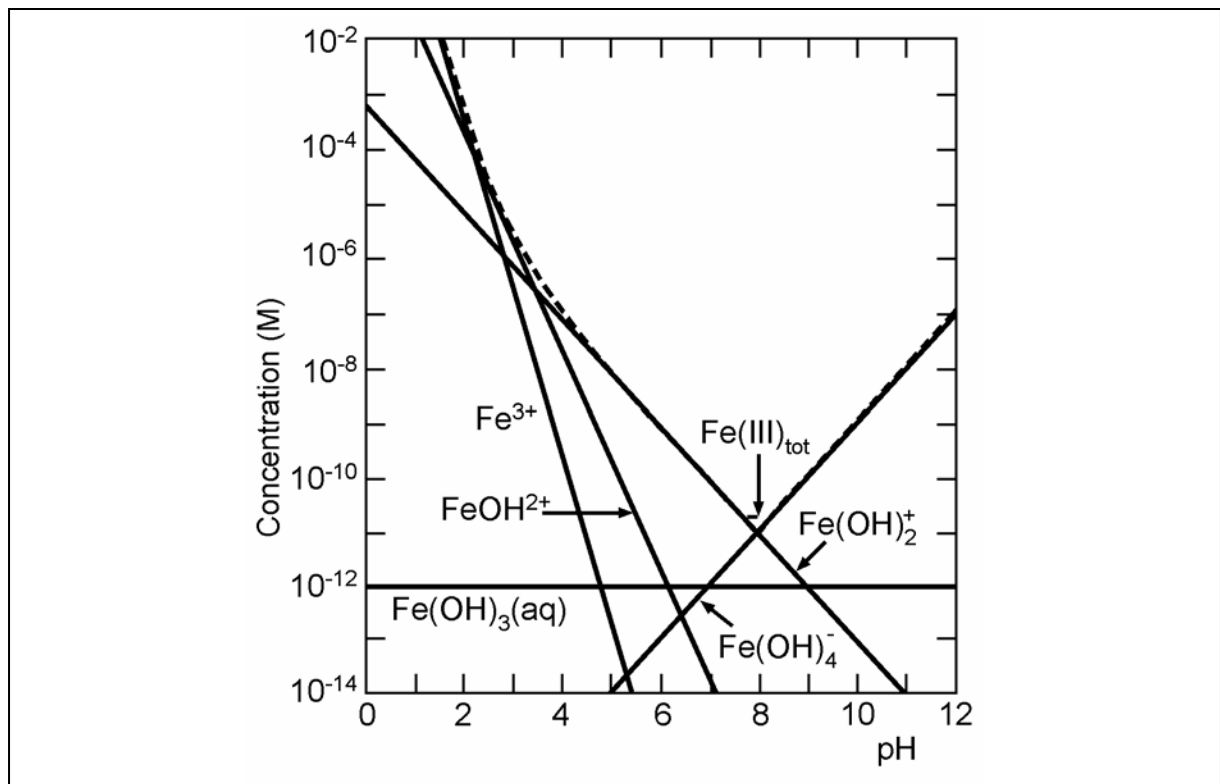

Fig. 7b: pH dependence of solubility of ferric hydroxide species in water. The dashed line represents total  $\text{Fe}^{\text{III}}$  solubility (after Stumm & Morgan, 1996 and Younger et al., 2002).

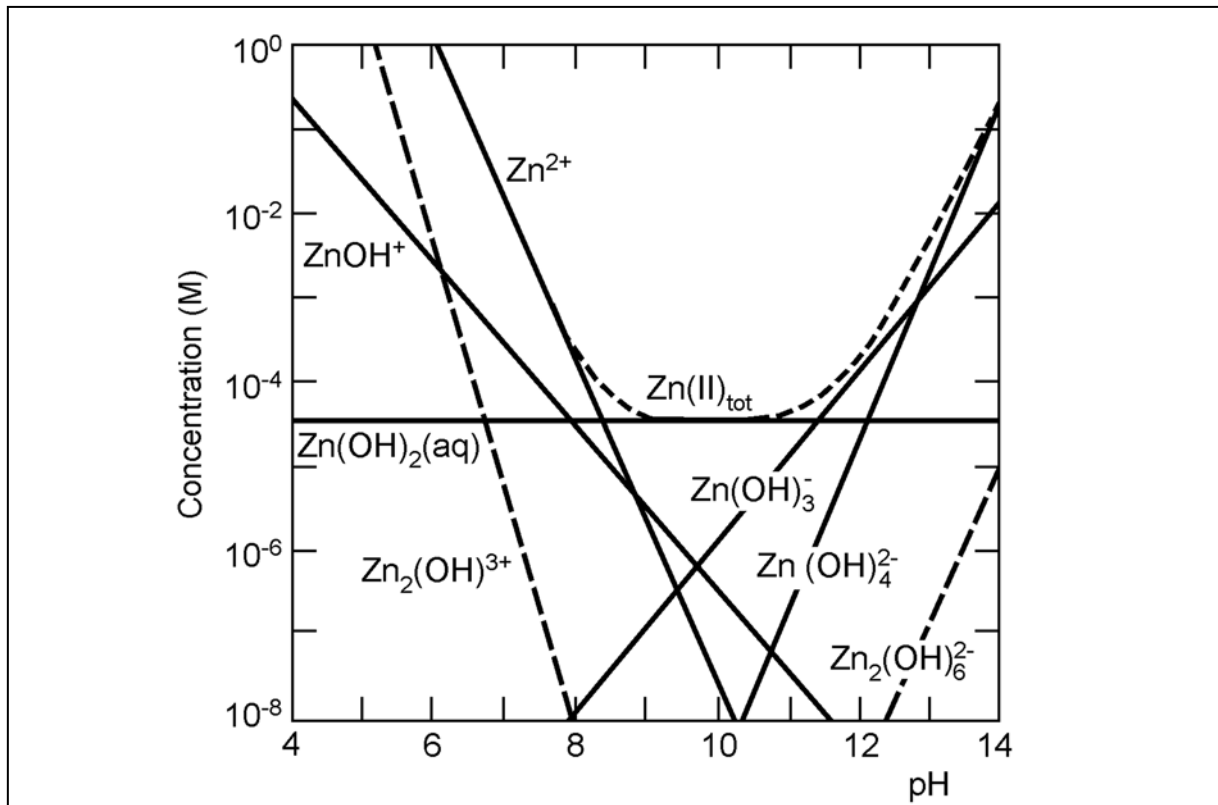

Fig. 7c: pH dependence of solubility of zinc hydroxide species in water. The dashed line represents total Zn solubility (after Stumm & Morgan, 1996 and Younger et al., 2002).

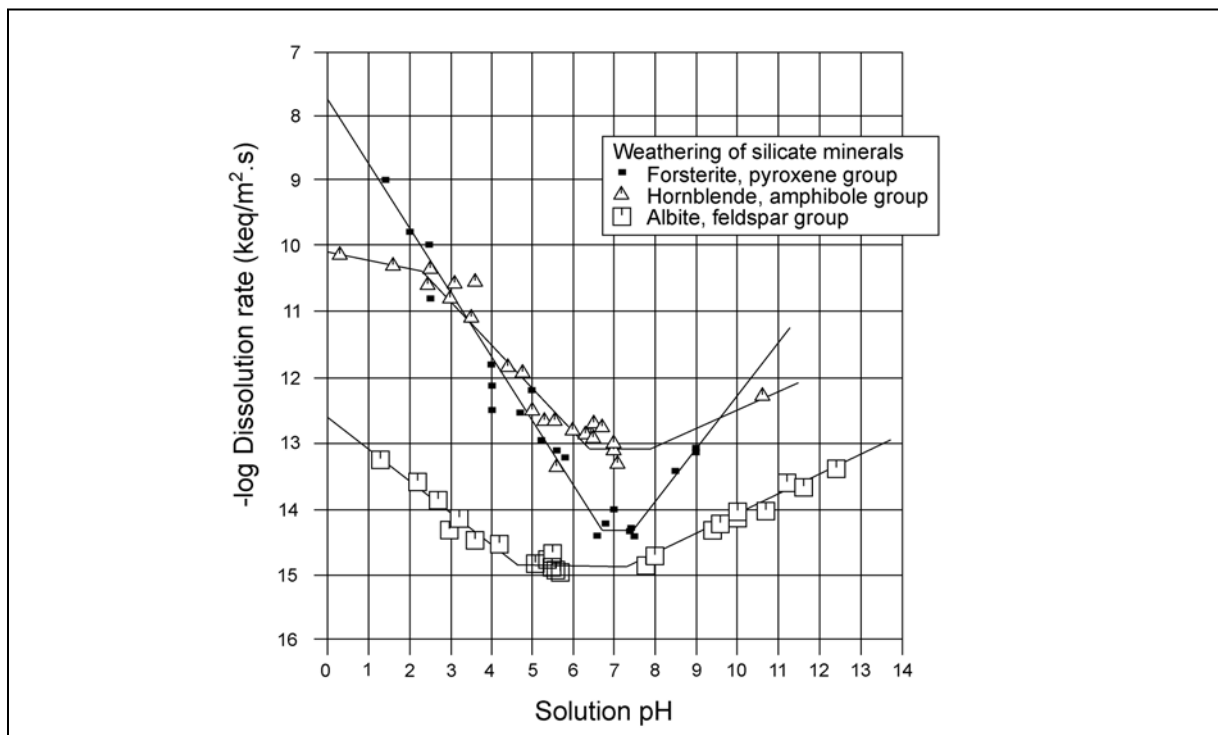
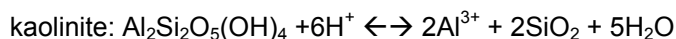
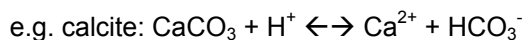

Fig. 8: Experimentally determined reaction (dissolution) rates for selected silicate minerals at varying pH values at 25°C (after Sverdrup & Warfvinge, 1988 and Appelo & Postma, 1996).

pH can also be regarded as a master variable because it controls the rate (Figure 8) and extent of acid-base reactions: i.e. most weathering reactions:



## Equilibrium Constants

Reversible reactions in solution can be characterised by an equilibrium constant  $K_{\text{eq}}$  where:

$$K_{\text{eq}} = \phi (\text{products}) / \phi (\text{reactants})$$

and where ( ) is an activity in mole/dm<sup>3</sup>

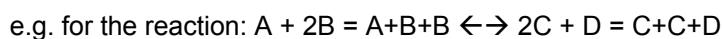

$$K_{\text{eq}} = [(\text{C}).(\text{C}).(\text{D})]/[(\text{A}).(\text{B}).(\text{B})] = [(\text{C})^2(\text{D})]/[(\text{A})(\text{B})^2]$$

For example, water dissociates reversibly to hydrogen and hydroxide ions:

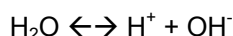

The dissociation constant (at 25°C) is:

$$K_{\text{eq}} = (\text{H}^+)(\text{OH}^-)/(\text{H}_2\text{O}) = (\text{H}^+)(\text{OH}^-) = 10^{-14} \text{ mol}^2/\text{dm}^6$$

NOTE: activity of water and solid phases are, by default, set to unity. Thus, in a neutral solution  $(\text{H}^+) = (\text{OH}^-) = 10^{-7} \text{ mol}/\text{dm}^3$ . In other words, pH = 7 at 25°C in a neutral solution.

## Gypsum

If we take, as a slightly more sophisticated example, the precipitation and dissolution of gypsum, we can attempt to answer the question: If gypsum is dissolved in water at 25°C, what activities (concentrations) of calcium and gypsum result ??



from hydrochemical data Tables (Appelo & Postma 1996), we can find that, at 25°C,  $K_{\text{eq}} = 10^{-4.58}$

$$K_{\text{eq}} = (\text{Ca}^{2+}).(\text{SO}_4^{2-}).(\text{H}_2\text{O})^2/(\text{CaSO}_4 \cdot 2\text{H}_2\text{O}) = (\text{Ca}^{2+}).(\text{SO}_4^{2-}) = 10^{-4.58} \text{ mol}^2/\text{dm}^6$$

Thus, as  $(\text{Ca}^{2+}) = (\text{SO}_4^{2-})$ , the activity of both calcium and sulphate must be:  $10^{-2.29} \text{ mol}/\text{dm}^3$ , for dissolution of gypsum in water at 25°C. If we make the (rather naughty, and strictly untenable) assumption that activity approximates to concentration, we can suggest the *approximate* concentrations of calcium and sulphate one might expect upon gypsum saturation:

Calcium weighs 40,080 mg/mol, thus  $10^{-2.29} \text{ mol}/\text{dm}^3 \text{ Ca} = 206 \text{ mg}/\text{l}$

Sulphate weighs 96,064 mg/mol, thus  $10^{-2.29} \text{ mol}/\text{dm}^3 \text{ SO}_4^{2-} = 493 \text{ mg}/\text{l}$

Programs such as MINTEQA2 (USEPA 1991) and PHREEQC (Parkhurst, 1995) allow more rigorous calculations to be made, taking full account of speciation of ions, and calculation of activity coefficients.



We can thus state that mine waters containing *more* than the above activities of calcium and sulphate will tend to have a tendency to precipitate gypsum. We can define a *Saturation Index (SI)*, the ratio of the product of the activities of the relevant ions to the  $K_{eq}$ :

$$SI = \log_{10}[(Ca^{2+}) \cdot (SO_4^{2-}) / K_{eq}]$$

If  $SI = 0$ , an equilibrium exists. If  $SI > 0$ , there is a tendency for gypsum to precipitate and the water is said to be *oversaturated* with respect to gypsum. If  $SI < 0$ , there is a tendency for gypsum to dissolve and the water is said to be *undersaturated* with respect to gypsum.

For example, the San José mine water of Oruro, Bolivia (Table 1) contains:

$$1780 \text{ mg/l Ca} = 0.044 \text{ mol/dm}^3$$

$$8477 \text{ mg/l sulphate} = 0.088 \text{ mol/dm}^3$$

If we again make the rather naughty assumption that concentration approximates to activity (and if we ignore temperature):

$$SI = \log_{10} [(Ca^{2+}) \cdot (SO_4^{2-}) / K_{eq}] = \log_{10} [(0.044)(0.088) / 10^{-4.58}]$$

$$= \log_{10}(0.00387) + 4.58 = -2.41 + 4.58 = 2.2$$

Thus, we can guess that the water is significantly *oversaturated* and that gypsum will tend to precipitate in the minewater channel. We should run a speciation program, such as PHREEQC, to confirm this, however, and to take full account of activity effects.

### Iron Oxyhydroxide

We can use the concept of equilibrium constants to examine the solubility of ferric hydroxide, to understand how diagrams such as Figure 7b are generated.

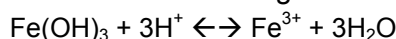

Ferric oxyhydroxide can take a number of forms (amorphous, microcrystalline) and its  $K_{eq}$  is difficult to pin down to an absolute value. However, Appelo & Postma (1996) suggest a value of:

$$K_{eq} = 10^4 = (Fe^{3+}) / (H^+)^3$$

Thus, for systems in equilibrium with  $Fe(OH)_3$

$$\log(Fe^{3+}) = 4 + 3\log(H^+)$$

$$\log(Fe^{3+}) = 4 - 3pH$$

This equation approximately corresponds to the line marked  $Fe^{3+}$  on Figure 7b. So, when  $pH = 6$ ,  $(Fe^{3+}) = 10^{-14} \text{ mol/dm}^3$ . When  $pH = 2$ ,  $(Fe^{3+}) = 10^{-2} \text{ mol/dm}^3 = 10 \text{ mmol/l}$ . This explains the very low solubility of ferric iron at high pH and appreciable solubility at very low pH.

### Master Variable: Eh

The redox potential, Eh (measured in mV) describes the redox state of a solution. The lower the value, the more reducing the solution. The higher the value, the more oxidising. Eh is, in fact, a measure of the electron activity of the solution, in the same way that pH is a measure of the proton activity. Eh controls the oxidation state of elements that can exist in several oxidation states, e.g. Fe and S (Figure 9).

Garrels & Christ (1965) produced a diagram illustrating typical Eh and pH conditions for various terrestrial environments (Figure 10).

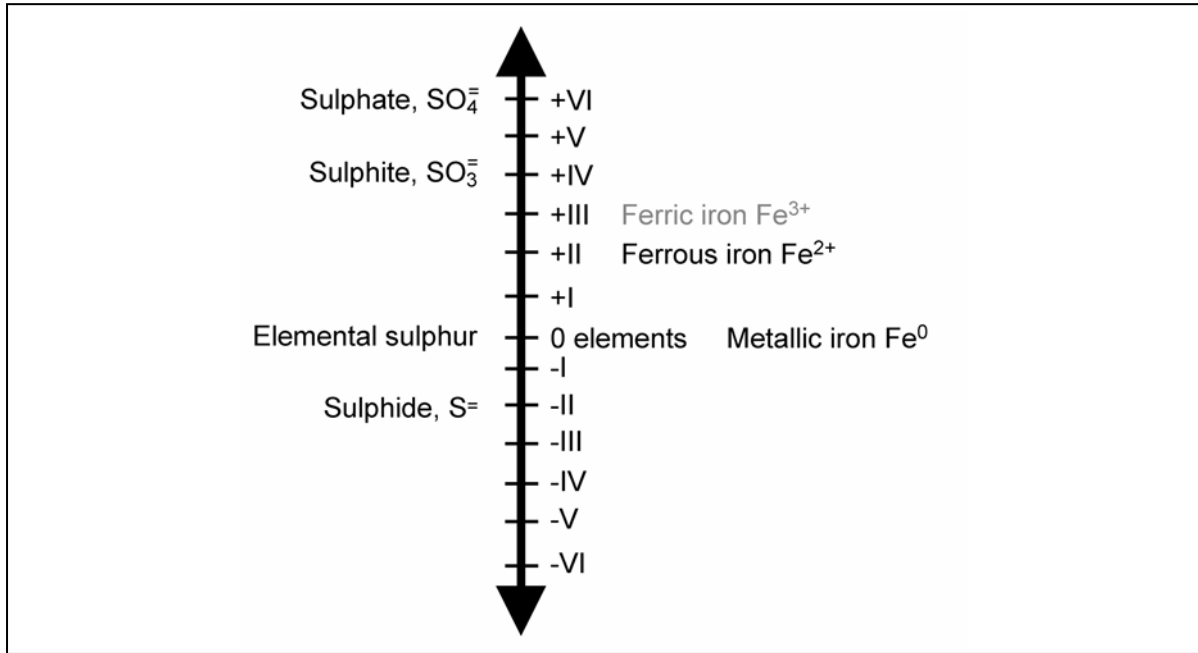

Fig. 9: Redox "ladder" showing some of the possible oxidation states of iron and sulphur.

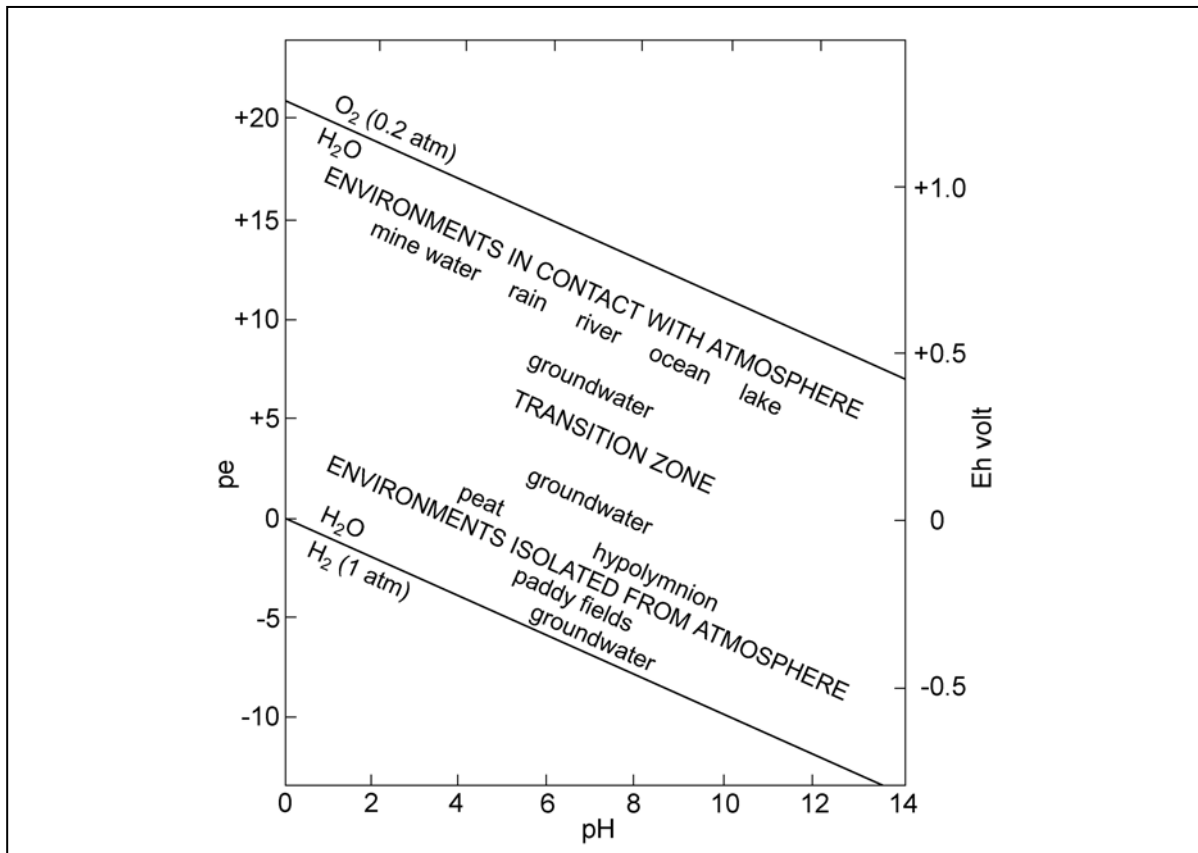

Fig. 10: The stability of water and the range of natural redox and pH environments (after Garrels & Christ, 1965 and Appelo & Postma, 1996).

Figure 10 is an example of a powerful tool used by hydrochemists: the pH – Eh diagram. Such diagrams (Figure 11) show the stable phases of a combination of elements in solution for a variety of Eh and pH values. It is important to realise that each diagram is valid only for specific total element concentrations and for given temperature and pressure conditions. The example in Figure 11 illustrates the following:

- € That pyrite is stable in circum-neutral, reducing conditions: i.e. the subsurface geosphere
- € By moving vertically from the pyrite field (i.e. by increasing Eh), we see that pyrite becomes unstable and gives way to siderite or ferric oxyhydroxide fields. In acid conditions, as in mine water, dissolved ferrous (and, under extremely oxidising and acid conditions, ferric) ions are the most stable phases.

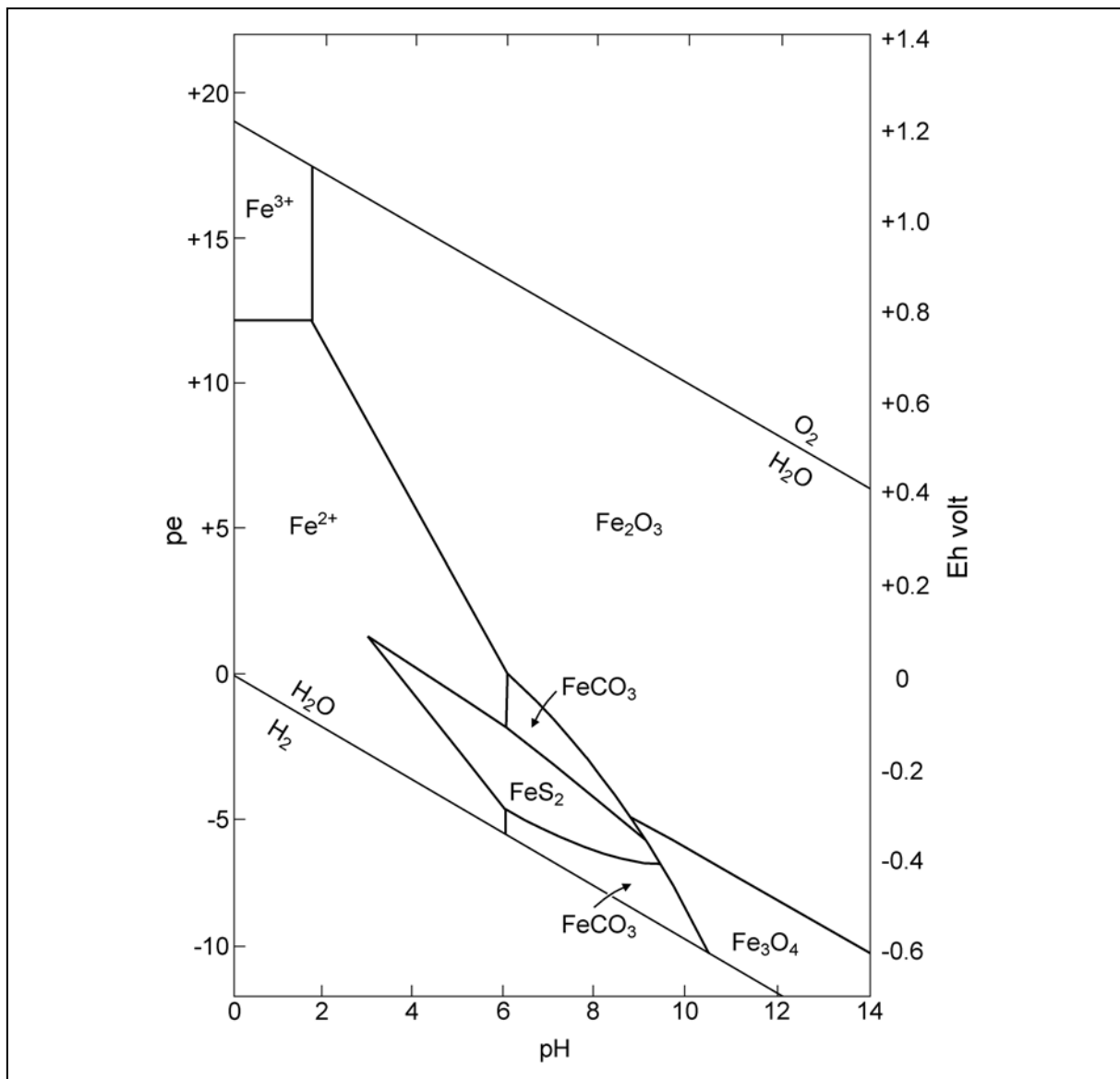

Fig. 11: Eh-pH diagram for the system Fe-C-S-H<sub>2</sub>O, where Total S = 10<sup>-6</sup> M, Total C = 10<sup>0</sup> M, Fe<sup>2+</sup> = 10<sup>-6</sup> M and T = 25°C (after Appelo & Postma, 1996).

## Acidity and Alkalinity

These terms cause great confusion to hydrochemists, largely because they are constructed, rather than *a priori* concepts, and because there are several similar, but subtly different, definitions of the concepts. Broadly speaking, alkalinity can be defined as:

- € The capacity of a solution to neutralise acid
- € The total (in meq/l) of basic species in a solution
- € The amount of strong acid (meq/l) needed to reduce the pH of the solution to a given value (often around 4.3)

In most natural groundwaters, alkalinity (in meq/l) can be said to be approximately given by:

$$\text{Alkalinity} = -[\text{OH}^-] + 2[\text{CO}_3^{2-}] + [\text{HCO}_3^-]$$

where [ ] = concentration in mmol/l. Similarly, *acidity* can be defined as:

- € The capacity of a solution to neutralise alkalis
- € The total (in meq/l) of acidic species in a solution
- € The amount of strong alkali (meq/l) needed to increase the pH of the solution to a given value (often around 8.2)

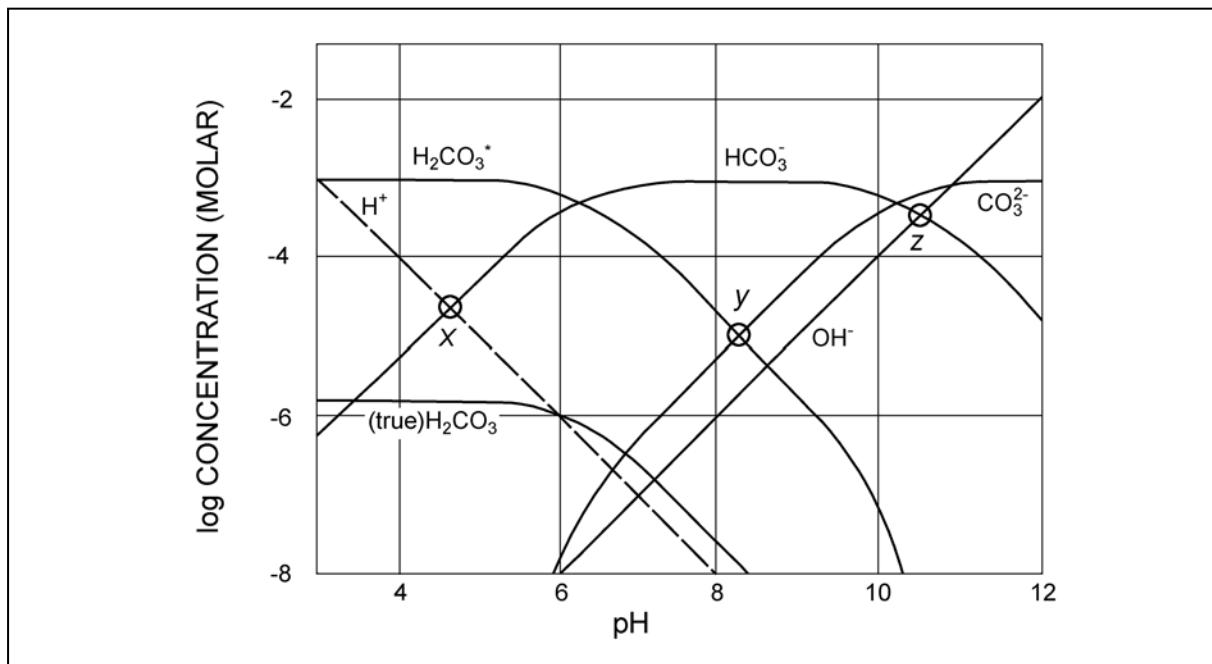
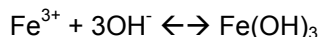
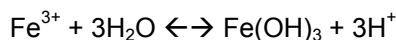

Fig. 12: Concentrations of individual inorganic carbon species in water as a function of pH in a system closed to  $\text{CO}_2$  (after Stumm & Morgan, 1996).

One may ask: what's special about pH 4.3 and pH 8.2 as the titration end points. In fact, by the time pH has decreased to pH 4.3 during acid titration, almost all the bicarbonate in a solution has been used up and converted to carbonic acid. Likewise, by the time pH has been raised to 8.2 during an alkali titration, carbonic acid has effectively been converted to bicarbonate in a closed system. In fact, theoretical considerations (Younger et al., 2002) suggest that, for acid mine drainage problems, where mine water is exposed to environments that are open to  $\text{CO}_2$  and where the carbonate system dominates, a more suitable end-point for alkalinity and acidity titrations would be pH = 5.64.

Acidity and alkali are best measured in the field by empirical titration. However, acidity can also be estimated from chemical analyses. Acidity is due not only to protons ( $H^+$ ) but to potentially oxidisable and hydrolysable metals



Thus, in a sense, each ferric ion in solution has the ability to liberate three protons (or consume three hydroxide ions) on hydrolysis, and is thus equivalent to three units of acidity.

Similarly:

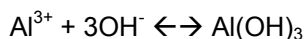

$Al^{3+} = 3$  units of acidity

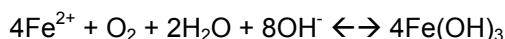

$Fe^{2+} = 2$  units of acidity

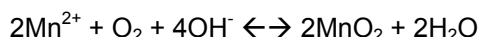

$Mn^{2+} = 2$  units of acidity

Thus, calculated acidity (in meq/l) is given by (e.g. Hedin et al. 1994).

$$\text{Acidity} = [H^+] + 3[Fe^{3+}] + 3[Al^{3+}] + 2[Fe^{2+}] + 2[Mn^{2+}] + \dots \text{other relevant species}$$

where [ ] is a concentration, in mmol/l. This is only an approximation, however, and is subject to inaccuracies due to the facts that:

- (i) not all ferric iron in solution will be in the form of  $Fe^{3+}$ . It may form complex species.
- (ii) ferric iron and aluminium and other metals may be present in analytical samples in the form of iron oxyhydroxide colloids, or even humic colloids.

If alkalinity of a minewater exceeds acidity, it is said to be “net alkaline”. If acidity of a minewater exceeds alkalinity, it is said to be “net acid”. These concepts have important implications for how mine waters are to be treated: i.e. whether they are suitable for active or passive treatment, whether they can be treated using aerobic wetlands or anaerobic basins.

### PART 3: PREDICTING MINE WATER CHEMISTRY

The chemistry of a mine water will be determined by the master variables:

- € pH (proton activity), which will be determined by the balance between amounts and rates of proton generating reactions and proton consuming (alkalinity generating) reactions
- € Eh (electron activity), determined by access to oxidizing species (e.g. oxygen) and access to reducing species (e.g. organic C)

Some engineers have tried to assess *acidity generating potential* of waste heaps or mines by:

- € summing the acid generating species present (e.g. sulphides)
- € summing the acid consuming species present (e.g. carbonates)

In the least sophisticated methods, the acid generating species are typically quantified by analysing total S and assuming it is all present as sulphide. The acid consuming species are quantified by assessing the neutralising potential by treatment of crushed rock with hot HCl and then titration. Clearly, this acid-base accounting approach is fraught with problems:

- € not all sulphides generate acid
- € sulphur may be present as sulphate

- ∄ not all sulphide may be exposed to oxygen (heterogeneity)
- ∄ hot HCl treatment may overestimate field reactivity
- ∄ silicate weathering may also consume protons
- ∄ carbonates may not come into effective contact with mine water (heterogeneity)
- ∄ rates of reaction are important, as well as quantities
- ∄ particle size is not considered

The approach is probably most applicable for homogeneous mine waste tips, over a short-to-medium term time period. More sophisticated techniques use reaction cells and less aggressive conditions and are assessed in some detail by Banwart et al. (2002).

In fact, the pH of the mine water, which in turn will be dominant control on the metal concentrations in the water, will ultimately be controlled by:

- ∄ the rates of proton-generating reactions
- ∄ the rates of proton consuming reaction

and these rates *may* not be constant with time.

### Proton-Generating Reactions

These include, pyrite oxidation and metal hydrolysis

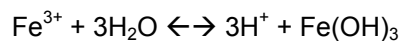
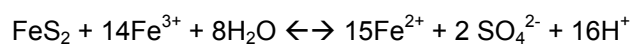
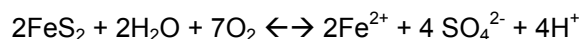

It should be noted that pyrite can be oxidised both by oxygen *and* by ferric iron, if present in the mine system. Oxidation by  $\text{Fe}^{3+}$  is considerably faster than by  $\text{O}_2$ . Thus, production of  $\text{Fe}^{3+}$  in the mine system by oxidation of  $\text{Fe}^{2+}$ , which is a typically slow reaction, is often the limiting step in the kinetics of pyrite oxidation (Figure 13).

Reaction cell experiments yield apparent (normalised, lab-determined) reaction rates ( $r_{\text{py}}$ : dimension  $[\text{M.L}^{-2}.\text{T}^{-1}]$ ) for pyrite oxidation that are sometimes assumed to be up-scalable to field conditions ( $R_{\text{py}}$ ) by simple factors such as:

- ∄  $m_{\text{py}}$ , the mass of pyrite present [M]
- ∄  $a_{\text{py}}$ , the specific surface area  $[\text{L}^2.\text{M}^{-1}]$

$$R_{\text{py}} = r_{\text{py}} \cdot a_{\text{py}} \cdot m_{\text{py}}$$

However, many more factors will affect pyrite oxidation kinetics than just surface area:

- ∄ concentrations of reactants ( $\text{O}_2$ ,  $\text{Fe}^{3+}$ ) – abiotic rate increases as concentrations increase
- ∄ temperature (abiotic rate decreases with temperature)
- ∄ pH (abiotic rate decreases as pH decreases)
- ∄ bacterial activity
  - bacterially mediated pyrite oxidation may be 25–34 times faster than abiotic oxidation
  - bacterially mediated  $\text{Fe}^{2+}$  oxidation may be 106 times faster than abiotic oxidation
  - *Thiobacillus ferrooxidans* thrives at a pH range of 1.5 to 3.0.
- ∄ nutrient concentrations, temperature will influence bacterial activity

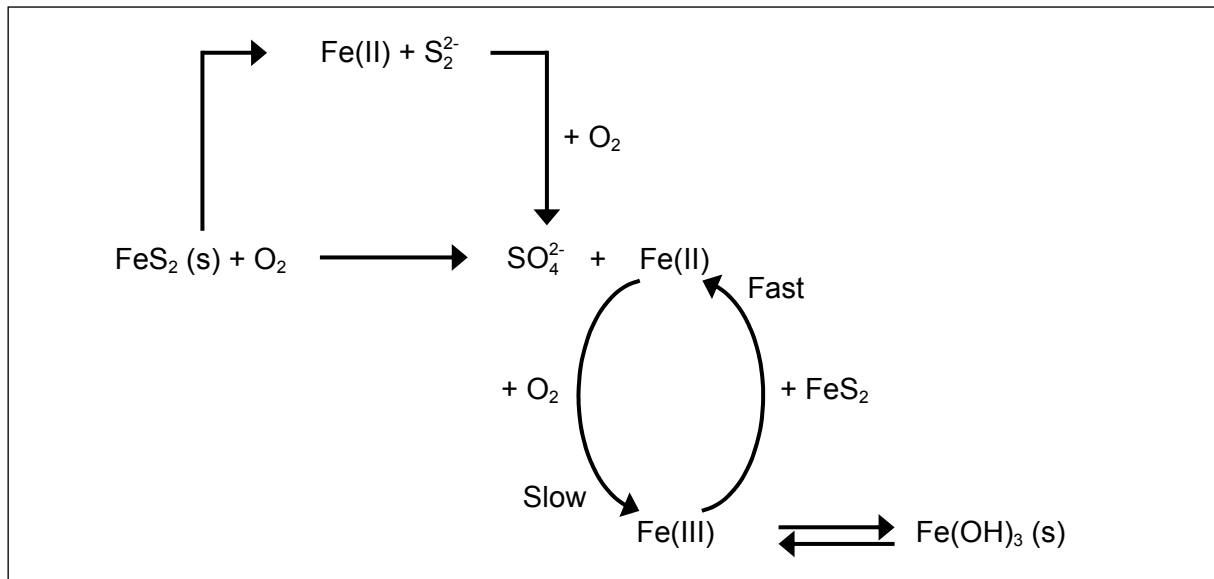

Fig. 13: Simplified diagram illustrating reaction pathways for pyrite oxidation (modified after Stumm & Morgan, 1981).

In other words, *bacteria* cause pyrite oxidation to occur under acidic conditions, and in particular, they catalyse appreciably the rate determining step ( $\text{Fe}^{2+}$  oxidation). It is open to question whether laboratory reaction cells can adequately simulate *in situ* microbiological conditions.

Although the number of interacting processes involved in mine water biogeochemistry can appear to be so intimidatingly large as to render the prediction of water's hydrochemical composition intractable, it may be possible to dramatically simplify the problem by identifying one rate-determining step. For example, in fine-grained mine wastes, the migration of oxygen into the wastes may be slow enough that it becomes such a rate-determining process, imposing a limit on the biotic or abiotic oxidation of pyrite. The complexity of issues then reduces to a physical problem of characterising the rate of migration of the oxidation front and a chemical problem of quantifying the rate of consumption of oxygen by sulphide oxidation or by organic carbon (which may be a competing process for oxygen).

### Proton-Consuming, Alkalinity-Generating Reactions

These include, reaction with carbonate minerals, if present:

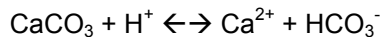

FAST

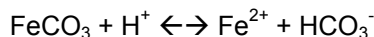

(Note that, although siderite has an immediate neutralising effect, it releases iron that may ultimately hydrolyse and re-release protons, contributing to net acidity).

Bicarbonate, if present in ambient groundwater, may also neutralise protons:

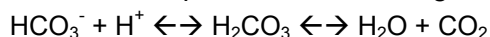

Silicate weathering (SLOW)

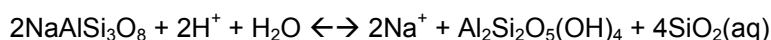

Clay hydrolysis

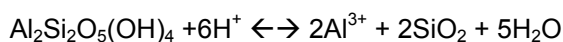

Sulphate reduction

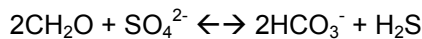

Rates of carbonate and silicate dissolution increase with increasingly acidic pH conditions (Figure 14 and Plummer et al., 1978). However, typically, calcite reacts several orders of magnitude more quickly than pyrite oxidises (especially at low pH) and most silicates react several orders of magnitude slower.

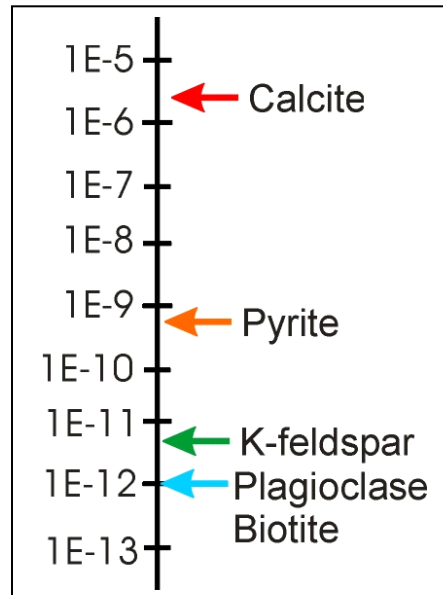

Fig. 14: Schematic showing relative abiotic laboratory mineral reaction rates (mole/m<sup>2</sup>/s) for pH=7 (modified after Younger et al., 2002).

As a result of these differing reaction kinetics, Strömberg & Banwart (1994, 1999) have predicted that minewater chemistry might be expected to evolve over time (see also Wiggering, 1993). In the early life of a mine waste tip, for example, any calcite present would be used up rapidly by the oxidation of pyrite. Thus, initially, the presence of minor amounts of calcite would be expected to maintain a relatively high pH in the leachate from the mine waste. Due to fast reaction kinetics, the calcite would eventually be consumed, if present in less amounts than pyrite. pH would then drop, as silicate weathering would be too slow to effectively neutralise acid generated by pyrite oxidation. With time, however, the pyrite content would diminish and silicate neutralisation might become significant. Thus the leachate draining from a mine waste pile comprising:

- ∄ a dominant fraction of silicate waste rocks
- ∄ some residual pyrite
- ∄ a minor content of calcite,
- ∄ residual deep saline and alkaline pore water

might be expected to evolve as through the following four phases, assuming the mine waste behaved homogeneously:

- ∄ Phase 1: Flushing of saline pore water from waste rock. Alkaline saline leachate
- ∄ Phase 2: Consumption of calcite by acid generated by pyrite weathering. Circum-neutral pH.
- ∄ Phase 3: Calcite fully consumed. pH drops dramatically as pyrite oxidation proceeds unbuffered
- ∄ Phase 4: Pyrite begins to be used up. Silicate buffering becomes significant. pH rises.



Of course, in real, heterogeneous, mine wastes, the picture will not be so simple. Such flushing and geochemical processes may take places in zones, related to the progressive inward/downward migration of recharge water and oxygen, or within “hot spots” or preferential pathways with good access to water and oxygen throughflow.

## PART 4: FINALLY

### Other Types of Mine Water Pollution

Of course, although sulphide oxidation, leading to the phenomenon of acid rock drainage, is the most familiar type of mine drainage pollution, other issues may also arise (Banks et al., 1997b):

- € Salinity: saline mine waters may be derived from salt mines, or from deep coal (e.g. Tilmanstone, Kent: Buchan 1962) or metals mines (e.g. San José, Bolivia: Banks et al., 2002a), where deep saline formation waters may be encountered. Alternatively, saline waters may be derived from intrusion of sea water in near-coastal mines. At Tilmanstone, disposal (infiltration) of saline mine waters led to significant contamination of the regionally important Chalk aquifer.
- € Ammonium: deep coal mines, especially in shaley, mudstone environments (e.g. in the East Midlands of the UK: Banks et al., 1997a,b) are known to produce pumped mine waters with a high content of ammonium (and a high salinity, Downing & Howitt, 1969). Discharge of ammonium to recipient watercourses is regarded as a significant water quality issue in this context.
- € Nitrate: use of nitrogen-based explosives in mining or quarrying can lead to elevated nitrate concentrations in groundwaters. This phenomenon is documented to have led to the contamination of a borehole near a quarry at Kopperå, Norway (T. Moseid, pers. comm.) and is suspected at some Siberian iron ore mines (Banks et al., 2002b).
- € Oil/drilling fluids: Contamination by oils or drilling fluids used in the mining or quarrying process is also a recognised threat (Arnesen & Iversen, 1995).
- € Radium and barium: in deep coal mine waters, which are low in sulphate (reducing environment), the solubility product of the relevant sulphate mineral (barite) may not be a limiting factor for barium solubility. Thus, elevated concentrations of barium, and its chemical analogue, radium, may occur. This phenomenon is documented from the Tyneside coalfields of the UK, and the Silesian coalfields of Poland (Banks et al., 1997b, Lebecka et al. 1994).
- € Organics: the presence of organic micro-contaminants in mine waters from coal or lignite mines is poorly researched. However, a tentative link between refractory fluorescent substances in waters related to lignite exposures with Balkan endemic nephropathy has been suggested (Goldberg et al., 1994).

### Minewater: an Environmental Resource

While minewater pollution tends to experience an unremittingly negative press coverage, it should be remembered that mine waters can also be regarded as an environmental resource, as documented by Banks et al. (1996):

- € Mine water discharges may provide low-N, bacteriologically pure baseflow to rivers: for example, the Rivers Drone and Dove in Derbyshire and Yorkshire, UK, which are otherwise very highly loaded with sewage effluent.

- € Mine water discharges from limestone-hosted sulphide mines can be of high enough quality to be used as sources of drinking water (e.g. Meerbrook Sough, Derbyshire, UK)
- € Mine waters can be sources of minerals (such as alkali salts, barium: Tyneside, UK) or can be employed as mineral water spas (Matlock, Derbyshire, UK [Albu et al., 1997] and Joachimstal)
- € Ferruginous mine waters have been used in practice as flocculating agents at sewage treatment works (Buxton, Derbyshire, UK: Roberts & Leach, 1985). Ferric sulphate is a recognised flocculent salt.
- € Mine water is an ideal source upon which to base heat pump solutions for space-heating and cooling of housing complexes, large commercial developments or public buildings. Examples can be found from Scotland, Norway, Canada and the USA (Banks et al., 2002c, in prep.)

## Acknowledgements

Much of the material presented above has been developed during the author's participation in short courses held with Professors Paul Younger and Steve Banwart at the Universities of Bradford and Newcastle, and with Dr Ingar Walder of SARB Consulting at the University of Göttingen (Germany) and the Kjeøy Conference Centre (Norway). The author thus owes a huge debt to these three specialists. While the author has endeavoured to draw upon examples and case studies from his own experience, he has to a large degree based this lecture upon the fundamental structure used by Steve Banwart in the book by Younger et al. (2002), and has derived several of the illustrations therefrom.

## References

- Albu, M., Banks, D. & Nash, H. (1997): *Thermal and Mineral Groundwater Resources*. Chapman & Hall, 447 pp.
- Appelo, C.A.J. & Postma, D. (1996): *Geochemistry, groundwater and pollution*. Balkema, Rotterdam, 536 pp.
- Arnesen, R.T., Nygaard, K., Iversen, E.R., Christensen, B., Slørdahl, A. & Bollingmo, Å. (1994): *Vannfylling av Wallenberg gruve [Water filling of Wallenberg mine – in Norwegian]*. Norsk Institutt for Vannforskning (NIVA) Report No. O-92174, 79 pp.
- Arnesen, R.T. & Iversen, E.R. (1995): *Transport av tungmetaller fra norske kisgruver [Transport of heavy metals from Norwegian sulphide mines – in Norwegian]*. Norsk Institutt for Vannforskning (NIVA) Report No. O-94021, 164 pp.
- Banks, D. (1994): The abandonment of the Killingdal sulphide mine, Norway: a saga of acid mine drainage and radioactive waste disposal. *Mine Water and the Environment* 13, 35–48.
- Banks, D., Younger, P.L. & Dumbleton, S. (1996): The historical use of mine-drainage and pyrite-oxidation waters in central and eastern England, United Kingdom. *Hydrogeology Journal* 4(4), 55–68.
- Banks, D. (1997): Hydrogeochemistry of Millstone Grit and Coal Measures groundwaters, south Yorkshire and north Derbyshire, UK. *Quarterly Journal of Engineering Geology* 30, 237–256.
- Banks, D., Burke, S.P. & Gray, C.G. (1997a): Hydrogeochemistry of coal mine drainage and other ferruginous waters in north Derbyshire and south Yorkshire, UK. *Quarterly Journal of Engineering Geology* 30, 257–280.

- Banks, D., Younger, P.L., Arnesen, R.-T., Iversen, E.R. & Banks, S.B. (1997b): Mine water chemistry: the good, the bad and the ugly. *Environmental Geology* 32, 157–174.
- Banks, D., Frengstad, B., Midtgård, Aa.K., Krog, J.R. & Strand, T. (1998): The chemistry of Norwegian groundwaters: I. the distribution of radon, major and minor elements in 1604 crystalline bedrock groundwaters. *The Science of the Total Environment*, 222, 71–91.
- Banks, D., Holden, W., Aguilar, E., Mendez, C., Koller, D., Andia, Z., Rodriguez, J., Sæther, O.M., Torrico, A., Veneros, R. & Flores, J. (2002a): Contaminant source characterisation of the San José mine, Oruro, Bolivia. In Younger P.L. & Robins, N.S. (eds.) "Mine Water Hydrogeology and Geochemistry": *Geological Society Special Publication* 198, 215–239.
- Banks, D., Parnachev, V.P., Frengstad, B., Holden, W., Vedernikov, A.A. & Karnachuk, O.V. (2002b): Alkaline mine drainage from metal sulphide and coal mines: examples from Svalbard and Siberia. In Younger P.L. & Robins, N.S. (eds.) "Mine Water Hydrogeology and Geochemistry": *Geological Society Special Publication* 198, 287–296.
- Banks, D., Skarphagen, H., Wiltshire, R. & Jessop, C. (2002c): Mine water as a resource: space heating and cooling via use of heat pumps. *Proc. Conference "Mine water treatment: a decade of progress"*, Newcastle, Nov. 11–13, 2002.
- Banks, D., Skarphagen, H., Wiltshire, R. & Jessop, C. (*in prep.*): Heat pumps as a tool for energy recovery from mining wastes. In Gieré, R. & Stille, P. "Energy, Waste and the Environment: a Geochemical Perspective", *Geological Society Special Publication*.
- Banks, S.B. & Banks, D. (2001): Abandoned mines drainage: impact assessment and mitigation of discharges from coal mines in the UK. *Engineering Geology* 60, 31–37.
- Banwart, S.A., Evans, K.A. & Croxford, S. (2002): Predicting mineral weathering rates at field scale for mine water risk assessment. In Younger P.L. & Robins, N.S. (eds.) "Mine Water Hydrogeology and Geochemistry": *Geological Society Special Publication* 198, 137–157.
- Buchan, S. (1962): Disposal of drainage water from coal mines into the Chalk in Kent. *Proc. Society Water Treatment and Examination* 11, 101–105.
- Downing, R.A. & Howitt, F. (1969): Saline groundwaters in the Carboniferous rocks of the English East Midlands in relation to the geology. *Quarterly Journal of Engineering Geology* 1: 241–269.
- Edmunds, W.M., Cook, J.M., Kinniburgh, D.G., Miles, D.L. & Trafford, J.M. (1989): *Trace-element occurrences in British groundwaters*. British Geol. Survey Research Report SD/89/3.
- Frengstad, B. & Banks, D. (2000): Evolution of high-pH Na-HCO<sub>3</sub> groundwaters in anorthosites: silicate weathering or cation exchange? In: Sililo et al. (eds.): "Groundwater: Past Achievements and Future Challenges", Proc. XXXI<sup>st</sup> Congress of the International Association of Hydrogeologists. Cape Town, South Africa. Balkema, Rotterdam, 493–498.
- Garrels, R.M. & Christ, C.L. (1965): *Solutions, minerals and equilibria*. Harper & Row, New York, 450 pp.
- Goldberg, M.C., Feder, G.L. & Radovanovic, Z. (1994): Correlation of Balkan endemic nephropathy with fluorescent organic compounds in shallow ground water. *Applied Hydrogeology* 2, 4/94: 15–22.
- Hedin, R.S., Narin, R.W. & Kleinmann, R.L.P. (1994): *Passive treatment of coal mine drainage*. U.S. Bureau of Mines Information Circular 9389, U.S. Dept. of Interior, 35 pp.
- Iversen, E.R. & Knudsen, C.H. (1997): Kjemisk rensing av gruvevann fra Kongens Gruve i Nordgruvefeltet, Røros [Chemical treatment of minewater from the King's Mine in the northern mining field, Røros – in Norwegian]. *Norsk Institutt for Vannforskning (NIVA), Report 3632–97*, Project O-96099, Oslo.
- Lebecka, J., Chalupnik, S., Michalik, B., Wysocka, M., Skubacz, K. & Mielnikow, A. (1994): Radioactivity of mine waters in the Upper Silesian Coal Basin and its influence on the natural environment. *Proceedings of the 5th International Mine Water Congress, Nottingham, UK*, 18<sup>th</sup>–23<sup>rd</sup> September 1994: 657–662.
- Nilsen, R. & Banks, D. (1997): The interaction of water and dilute sulphuric acid with ore and rock material from selected Norwegian sulphide mines. *Norges geologiske undersøkelse Bulletin* 433, 58–59.

- Nuttall, C.A., Adams, R. & Younger, P.L. (2002): Integrated hydraulic-hydrogeological assessment of flooded deep mine voids by test-pumping at the Deerplay (Lancashire) and Frances (Fife) Collieries. In Younger P.L. & Robins, N.S. (eds.) "Mine Water Hydrogeology and Geochemistry": *Geological Society Special Publication* 198, 315–326.
- Parkhurst, D.L. (1995): *User's guide to PHREEQC ± a computer program for speciation, reaction-path, advective transport and inverse geochemical calculations*. US Geological Survey Water Resources Investigation Report 95-4227, Lakewood, Colorado.
- Plummer, L.N., Wigley, T.M.L. & Parkhurst, D.L. (1978): The kinetics of calcite dissolution in CO<sub>2</sub>-water systems at 5° to 60°C and 0.0 to 1.0 atm. CO<sub>2</sub>. *American Journal of Science* 278, 179–216.
- Roberts, A.F. & Leach, J.R. (1985): *The coal mines of Buxton*. Scarthin Books, Cromford, Derbyshire, UK, 95 pp.
- Stromberg, B. & Banwart, S.A. (1994): Kinetic modelling of geochemical reactions at the Aitik mining waste rock site in northern Sweden. *Applied Geochemistry* 9, 583–595.
- Stromberg, B. & Banwart, S.A. (1999): Experimental study of acidity-consuming processes in mining waste rock: some influences of mineralogy and particle size. *Applied Geochemistry* 14, 1–16.
- Stumm, W. & Morgan, J.J. (1981): *Aquatic chemistry (2<sup>nd</sup> Ed.)*. John Wiley & Sons, New York, 780 pp.
- Stumm, W. & Morgan, J.J. (1996): *Aquatic chemistry (3<sup>rd</sup> Ed.)*. John Wiley & Sons, New York.
- Sverdrup, H.U. & Warfvinge, P. (1988): Weathering of primary silicate minerals in the natural soil environment in relation to a chemical weathering model. *Water, Air and Soil Pollution* 38, 387–408.
- Vear A and Curtis C (1981): A quantitative evaluation of pyrite weathering. *Earth Surface Processes and Landforms* 6, 191–198.
- US EPA (1991): *MINTEQA2/PRODEFA2, a geochemical assessment model for environmental systems: version 3.0 user's manual*. US Environmental Protection Agency EPA/600/3-91/021, NTIS accession no PB91 182 469
- Wiggering H (1993): Sulfide oxidation – an environmental problem within colliery spoil dumps. *Environmental Geology* 22, 99–105.
- Younger, P.L. (1995): Hydrogeochemistry of minewaters flowing from abandoned coal workings in the Durham coalfield. *Quarterly Journal of Engineering Geology*, 28(4), S101–S113.
- Younger, P.L. (1997): The longevity of minewater pollution: a basis for decision-making. *The Science of the Total Environment* 194/195, 457–466.
- Younger, P.L. (2000): Predicting temporal changes in total iron concentrations in groundwaters flowing from abandoned deep mines: a first approximation. *Journal of Contaminant Hydrology* 44, 47–69.
- Younger, P.L., Banwart, S.A. & Hedin, R.S. (2002): *Mine water: hydrology, pollution remediation*. Kluwer, Dordrecht, 442 pp.

## Contact

David Banks  
Holymoor Consultancy  
8 Heaton Street, Brampton  
Chesterfield, Derbyshire  
S40 3AQ  
Phone: + 44 1246 23 00 68  
E-mail: david@holymoor.co.uk

## **TRACER INVESTIGATIONS IN FLOODED MINES – THE STRASSBERG/HARZ MULTITRACER TEST**

*Ch. Wolkersdorfer, A. Hasche, TU Bergakademie Freiberg, Department of Hydrogeology, Freiberg/Saxony, Germany*

*Keywords: Tracer test, flooded underground mine, tracer, abandoned mine, microspheres, hydrodynamics*

### **Abstract**

After having constructed three new water adits, the water budget of the abandoned Straßberg mine increased substantially. To solve the questions arisen from this, a multi-tracer test was conducted. By the use of potassium chloride, coloured club moss spores, and microspheres, the hydrodynamic relation between the three mining districts could be shown. Generally, the flow direction is from north to south, the mean effective flow velocities ranging from 0.1–1.5 m min<sup>-1</sup>. Furthermore, it is clear now, that a dam between two of the three pits is hydraulically inactive at the current flow situation. No reasons, up to now, were found for the increased water budget infiltrating from the Brachmannsberg mining district. It could be shown, that solid tracers in conjunction with a reliable injection and sampling technique are a good means to investigate the hydrodynamic conditions within this abandoned underground mine.

### **Introduction**

In 1991, economic and environmental reasons caused the closure of the Straßberg fluorspar mine, owned by the GVV (Gesellschaft zur Verwahrung und Verwertung von stillgelegten Bergwerksbetrieben mbH; Company for remediation and utilisation of abandoned mines Ltd; Kuyumcu & Hartwig, 1998). Situated in the Mid Harz Fault Zone of the eastern Harz Mountains (Fig. 1), approximately 30 km south of Quedlinburg and 6 km west of Harzgerode, the Straßberg mine (TK 4332 Harzgerode) was the most important producer of fluorite in the former GDR (Mohr, 1978). Besides fluorite, the hydrothermal polymetallic mineralisation of the vein structures comprises several ore minerals of Permian to Cretaceous age (e.g. pyrite, galena, sphalerite, chalcopyrite, arsenopyrite, wolframite, scheelite, siderite; Kuschka & Franzke, 1974).

At the beginning of the mining, which might go back more than 1000 years, silver, copper, and lead were the targets of the miners. From the 18<sup>th</sup> century until 1990, mining focused on fluorspar, which was mainly found in the deeper parts of the mine (Bartels & Lorenz, 1993). Sinking the Fluor dayshaft at the Straßberg pit in 1910 marked the start of the last production period and between 1950 and 1970, the VEB Harzer Spatgrube joined the three most important deposits of the Straßberg mining district by driving two deep adits on the 5<sup>th</sup> and 9<sup>th</sup> level (from north to south: Brachmannsberg pit: No 539 shaft, Straßberg pit: Fluor shaft and Glasebach pit: Glasebach shaft). Whilst the 3.5 km long Nordquerschlag (northern adit) connects the Brachmannsberg and Straßberg pit on the 5<sup>th</sup> level, the 1.5 km long Glasebachquerschlag (Glasebach adit) connects the Straßberg and Glasebach pits on the 9<sup>th</sup> level. Ultimately, when the ore reserves in the Brachmannsberg underground pit decreased in the 1980ies, a dam was constructed in the northern adit, to separate the water to be flooded Brachmannsberg pit from the Straßberg pit.

Tab. 1: Mean composition of the mine water in the Straßberg mine during the time of the tracer test (May 30<sup>th</sup>–July 27<sup>th</sup> 2000) in mg L<sup>-1</sup>. Li: < 0.1 mg L<sup>-1</sup>, NO<sub>3</sub>: < 0.5 mg L<sup>-1</sup>.

Shaft	n	Na	K	Ca	Mg	Fe	Mn	Cl	SO <sub>4</sub>	HCO <sub>3</sub>	F
No 539	15	22	2	56	21	21	12	28	198	64	5
Fluor	11	15	2	140	29	22	6	17	387	77	8
Glasebach	9	14	5	178	32	10	13	17	385	184	7

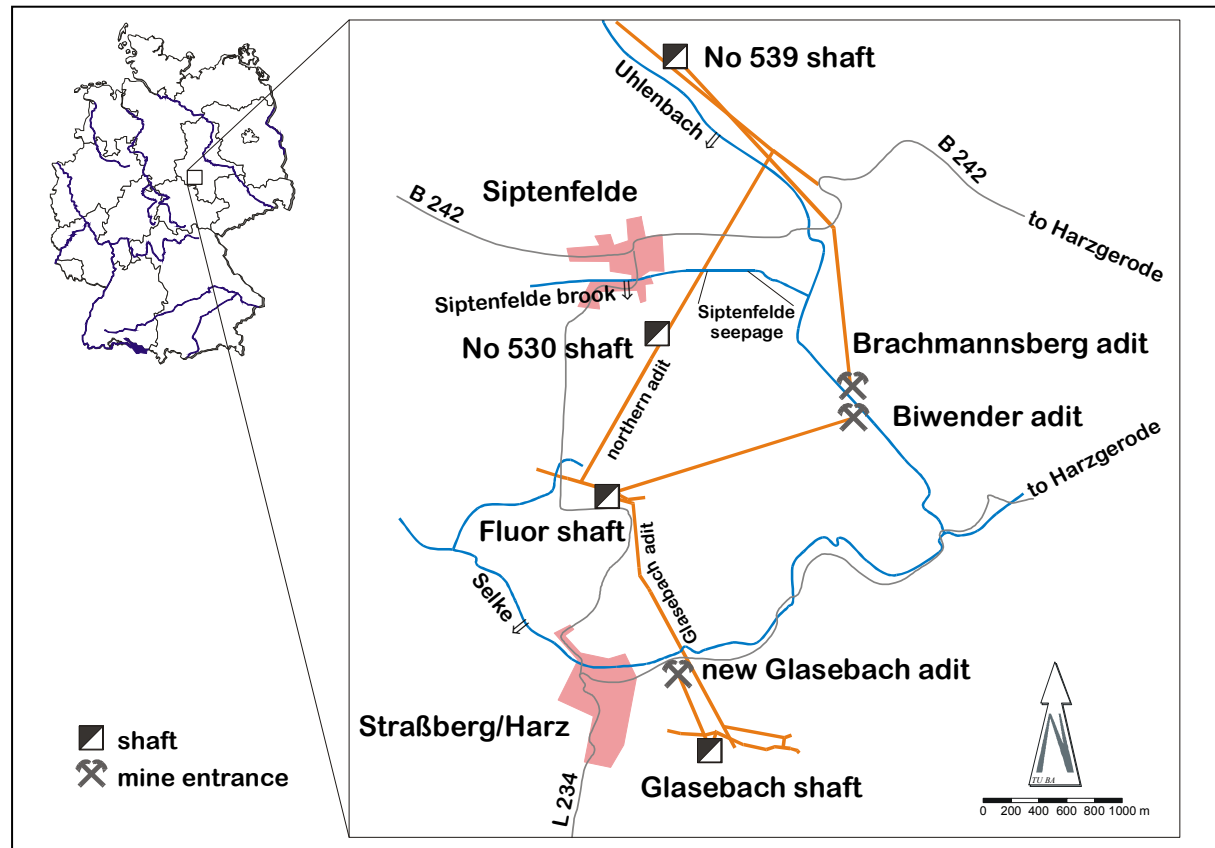

Fig. 1: Location of the Straßberg mine in the eastern Harz mountains and its main galleries and shafts

On May 31<sup>st</sup> 1991, by stopping the drainage water pumps, the Straßberg and Glasebach underground pits started to be flooded (Tab. 1). Between July 1992 and August 1998, accompanying in-situ temperature and conductivity measurements within the No 539 shaft and the Fluor shaft (310 and 147 m deep, respectively), clearly showed that a stratification within the water body was taking place (Kindermann, 1998, Rüterkamp & Messer, 2000). In the Fluor shaft, 3 water bodies, being separated from each other at the 2<sup>nd</sup> (328 mHN) and 5<sup>th</sup> (243 mHN) levels, established. Only 2 water bodies, separated by the 4<sup>th</sup> (357 mHN) level, could be recognised in the No 539 shaft. Evidence for the stratification were differences in temperature, conductivity, and metal-concentration between each of the water bodies (Tab. 2), the uppermost always low, the lowermost higher contaminated by iron, manganese, and sulphate.

Consequently, in 1993 the DMT – German Mining Technology, proposed to construct three new adits (Brachmannsberg adit, Biwender adit, new Glasebach adit; Fig. 1), to drain and treat the lower contaminated mine water within the uppermost water bodies at a water level of

357,7 mHN (Rüterkamp & Messer, 2000). These three adits were built between 1995 and 1998 and are draining the mine since then. Two provisional active water treatment plants near the Fluor shaft and in the Uhlenbach Valley (close to the entrances of the Brachmannsberg and Biwender adits) are cleaning the circum-neutral mine water (pH 6.2–8.0,  $n = 22$ , 95 % conf.) by the use of conventional liming technology.

After completion of the 3-adit-system in 1998, the stratification totally broke down in the No 539 shaft and partly in the Fluor shaft (Rüterkamp & Messer 2000, appendixes 1 and 5), resulting in a generally higher contaminant load than expected. Similar circumstances already had been found and investigated during the flooding of the Niederschlema-Alberoda mine (Erzgebirge/Germany, Wolkersdorfer, 1997a). There, as long as the water level was under a main level, stratification could be seen in the shafts above the last level that had been flooded. When the main level was flooded a new loop established and the stratification broke down immediately (Wolkersdorfer, 1996). Furthermore, the annual water budget of the Straßberg mine increased by almost  $2 \cdot 10^6 \text{ m}^3$ .

Due to the new circumstances after installing the 3-adit-system, the mine's owner suggested to conduct a tracer test within the flooded part of the mine. The aim of the tracer test was to investigate the hydrodynamic conditions within the mine and the pathways of the water between the three pits. Furthermore, it should be examined, if there was a connection between a small brook, the Siptenfelde brook, used as a sewer and the underground mine. Therefore a multi-tracer test with sodium chloride, microspheres, and club moss (*Lycopodium clavatum*) spores was carried out (Wolkersdorfer, 2000).

This paper describes the implementation and the results of the tracer test at the abandoned Straßberg mine conducted in June 2000.

Tab. 2: Selected constituents of the mine waters in the Fluor and No 539 shaft in  $\text{mg L}^{-1}$  before and after the 3-adit-system taken in use (after Rüterkamp & Messer, 2000). mHN: meters above Sea Level (Kronstadt elevation).

Depth, mHN	Fluor shaft						Depth, mHN	No 539 shaft					
	25.8.1997			24.2.2000				26.8.1997			24.2.2000		
	Fe	Mn	SO <sub>4</sub>	Fe	Mn	SO <sub>4</sub>		Fe	Mn	SO <sub>4</sub>	Fe	Mn	SO <sub>4</sub>
~ 340	40	8	466	31	6	359	367	22	1	143	23	1	204
284	42	9	478	27	11	417	272	79	2	389	22	1	196
204	52	19	600	50	18	525							

## Methods

### Previous Tracertests in Underground Mines

Published results of tracer tests in abandoned underground mines are rare. Until now, the results of only two tracer tests in flooded underground mines using colloidal tracers (microspheres with 15  $\mu\text{m}$  diameter and club moss spores) are published (Wolkersdorfer 1996, Wolkersdorfer et al., 1997a, 1997b). Skowronek & Zmij (1977) traced the pathway of a water inrush into a shaft and Goldbrunner et al., (1982) investigated the water inflow into a producing alpine magnesite mine. Aldous & Smart (1987) conducted a tracer test in an abandoned and flooded coal mine field by injecting a fluorescent dye tracer into the surrounding overburden. Another tracer test with fluorescent dyes was performed in a flooded mine by Davis (1998; Rico, Dolores County, Colorado). A yet unpublished tracer test with discontinuous sam-

pling of microspheres (0,4 µm diameter) was carried out in the Königstein mine (Elbtalzone/Germany; Käss, pers. comm. 2000). However, microspheres had been used successfully in ground water tracing (McKay et al., 1997, Moline et al., 1997, Turin & Reimus, 1997, Petrich et al., 1998, Becker et al., 1999).

To guarantee reliable results, continuous sampling of the tracer used is necessary. Unfortunately, microspheres and club moss spores cannot be sampled continuously, but quasi continuously using filters, that have to be changed regularly (Käss, 1998). Niehren & Kinzelbach (1998) presented an on-line microsphere counter (flow cytometer) for microspheres with a diameter of 1 µm and a flow rate of up to 1 mL min<sup>-1</sup> to be used in ground water studies. Due to the requirements on a tracer test in a flooded mine (rough underground conditions, high flow rates), and the conditions of the mine water itself (e.g. high suspension load), using a flow cytometer was unfeasible. Therefore, the methods, filter systems, and procedures described by Wolkersdorfer et al. (1997a) were used in a modified form.

## Tracer Injection

As the area under investigation extends about 5 km in north-south and 2 km in east-west direction, several injection and sampling points were needed (Fig. 1, Tab. 3). Coloured fluorescent microspheres with a 15 µm diameter (Triton Technology Inc, San Diego CA, USA; Zhang et al., 1998) were injected at 4 localities, thereunder one were also coloured club moss spores (Sigma-Aldrich Chemie GmbH, Deisenhofen/Germany) were used. 350 m east of Siptenfelde, saturated sodium chloride brine (Kali + Salz GmbH, Bernburg/Germany) was introduced into the Siptenfelde brook. Details of the tracer quantity injected and the injections times can be found in the Table (Tab. 3).

Based on the assumption, that 277,000 m<sup>3</sup> of water are in the mine and that 13,000 m<sup>3</sup> of water per day will be exchanged, the tracer amount was calculated. This resulted in 40 mL of microspheres per injection point, 500 g of spores and 20,000 L of saturated brine to be used for a successful tracer test.

For injecting the microspheres (June 5<sup>th</sup> 2000), two different injection techniques were used. In the No 539 shaft, the Fluor shaft and the Glasebach shaft, 3 LydiAs (Lycopodium Apparatus: probe for injecting colloidal tracers) were lowered down to 266 mHN (92 m below water level), 110 mHN (247 m below water level) and 354 mHN (4 m below water level), respectively. At the partly plugged No 530 shaft, connecting the northern adit to the surface, a different injection technique was used. 40 mL of microspheres were mixed with 50 L of clear water, poured into a borehole through the plug and flushed into the mine with another 1000 L of water.

Tab. 3: Injection points, depth in shafts, and injection times of the 7 tracers used. Add 40 hours to the times marked with an asterisk, as LydiA (Lycopodium Apparatus) opened approximately 40 hours later.

Injection points (depth)	Tracers	Quantity	Injection time
Siptenfelde brook	NaCl brine	20 m <sup>3</sup> (6.2 t)	June 2 <sup>nd</sup> : 9:08–10:15
No 539 shaft (92 m)	microspheres “blue”	40 mL	June 5 <sup>th</sup> : 14:44 *
No 530 shaft (20 m)	microspheres “orange”	40 mL	June 5 <sup>th</sup> : 9:50–10:13
Fluor shaft (247 m)	microspheres “red”	40 mL	June 5 <sup>th</sup> : 12:18 *
Fluor shaft (247 m)	spores “malachite green”	264.9 g	June 5 <sup>th</sup> : 12:18 *
Fluor shaft (247 m)	spores “saffron coloured”	279.5 g	June 5 <sup>th</sup> : 12:18 *
Glasebach shaft (4 m)	microspheres “green”	40 mL	June 5 <sup>th</sup> : 8:11 *



Tab. 4: Pump capacity of mini piston pumps and total amount of water pumped through the filter systems during the tracer test (June 5<sup>th</sup>–June 26<sup>th</sup> 2000).

Sampling point	Pump capacity	Water pumped through filters
No 539 shaft	0.08–0.13 L min <sup>-1</sup>	2,421 L
Fluor shaft	0.08–0.09 L min <sup>-1</sup>	2,419 L
Glasebach shaft	0.12–0.69 L min <sup>-1</sup>	5,038 L

To test the reliability of the microspheres and for correlation reasons, 544.4 g of club moss spores (malachite green, saffron coloured) were injected into the Fluor shaft at the same depth as the microspheres.

At the time of the tracer injection (June 2<sup>nd</sup> 2000), 30 L min<sup>-1</sup> of water were flowing in the Siptenfelde brook (measured at the pipe outlet Siptenfelde) and the water trickled away 410 m east of Siptenfelde (“Siptenfelde seepage”). Usually, the flow in the Siptenfelde brook ranges from 300–600 L min<sup>-1</sup> and it flows into the Uhlenbach brook, the latter one flowing into the river Selke. During summer time, the flow decreases and as soon, as the flow is lower than 300 L min<sup>-1</sup>, the Siptenfelde brook does not reach its mouth. 350 m east of Siptenfelde, near “tree one”, 20,000 L of saturated sodium chloride brine were introduced into the Siptenfelde brook with a flow rate of 300 L min<sup>-1</sup>. All of the brine was trickled away 150 m downstream “tree one”

During the tracer test, approximately 4.5 m<sup>3</sup> min<sup>-1</sup> of mine water flew out of No 539 shaft, 3 m<sup>3</sup> min<sup>-1</sup> left the Fluor shaft and 1 m<sup>3</sup> min<sup>-1</sup> the Glasebach shaft.

## Tracer Sampling and Analyses

Due to the tracers' characteristics, two different sampling techniques were used. The sodium chloride was detected by continuous conductivity measurements with sampling points at the Uhlenbach brook (PIC GmbH, Munich/Germany), No 539 shaft (LogIn GmbH, Gommern/ Germany), Fluor shaft (LogIn GmbH, Gommern/Germany) and the Glasebach shaft (EcoTech GmbH, Bonn/Germany). Filter systems, each with 300 µm and 15 µm filters (NY 300 HC, NY 15 HC; Hydro-Bios, Kiel/Germany), for collecting the solid tracers (microspheres, spores) were installed at No 539 shaft, Fluor shaft, and Glasebach shaft. Sampling was done by the use of mini piston pumps (Pleuger Worthington GmbH, Hamburg/Germany) being installed 5–10 m under the water surface (Tab. 4). Every 12 hours the filter system was changed and the filters were stored in 500 mL brown glass bottles.

Most of the 147 filter samples contained noticeable amounts of Fe-oxides. Therefore, oxalic acid was added to remove both, Fe-oxides and carbonates. In the laboratory, after at least one day of reaction, the filters were carefully rinsed and the solids filtered through 8 µm cellulose nitrate filters (Sartorius, Göttingen/Germany) with 47 mm diameter, using Nalgene plastic filters for membrane filtering with a hand vacuum pump. After each filtration the Nalgene filters, the filter unit, and the working tables in the laboratory were cleaned to exclude any kind of contamination during sample preparation.

After drying and mounting the 147 cellulose nitrate filters to glass plates, the fluorescent microspheres and the spores were counted under a fluorescence microscope (Leica, Wetzlar). Depending on the number of solid tracers on the filters, an aliquot part of the whole filter was counted and the whole number of solid tracers collected was calculated on the basis of these data.

In addition to the tracer test, 21 water samples were collected on a regularly basis (Tab. 1). The detailed results of these samples will be described elsewhere.

## Results

### Sodium chloride

An increase in conductivity could only be detected at the Fluor shaft (Fig. 2). Neither of the other sampling points (Uhlenbach brook, No 539 shaft, Glasebach shaft) showed a significant change in conductivity that would be caused by the sodium chloride tracer. During the time of conductivity measurements in the Fluor shaft (May 30<sup>th</sup> to July 31<sup>st</sup>) a total of 39 % (2.4 t) of the tracer injected (6.2 t) could be recovered. Considering the geological and tectonic conditions, this recovery rate is unexpectedly high, proving a good hydraulic connection between the Siptenfelde brook and the mine.

Approximately 1 day after a rainfall, the conductivity in the Fluor shaft increases significantly for 1 minute (June 11<sup>th</sup>, 7:49 p.m.) to 247 minutes (June 11<sup>th</sup>, 10:28 p.m.), the highest peak occurring on July 3<sup>rd</sup>, 9:34 p.m. (185 minutes). Each peak starts quickly and tails out slowly within the time mentioned before (see inset in Fig. 2). Based on a distance of 2,250 m between the Siptenfelde seepage and the Fluor shaft, a mean effective velocity of 1.5 m min<sup>-1</sup> can be calculated for the meteoric and mine water flowing between the brook and the shaft's outflow (Tab. 5).

### Club moss spores (*Lycopodium clavatum*)

Club moss spores were only detected at the Fluor shaft and the Glasebach shaft (Fig. 4). A total of 323,220 spores in the Fluor shaft and 200,820 in the Glasebach shaft could be found after June 8<sup>th</sup>. Based on the ratio of the water pumped and the water flowing out of the three shafts, the recovery rate is as high as 6 %.

Within the Fluor shaft, 2.5 days after tracer injection, the club moss spores peak reached 199,200 in a relatively short time and decreased to nearly 4,000 after 1.5 days. A second peak with 6,500 spores can be seen 6 days after tracer injection. From the injection point to the water's surface, the spores have to travel 238 m, thus the mean effective velocity calculates to 0.1–0.2 m min<sup>-1</sup>.

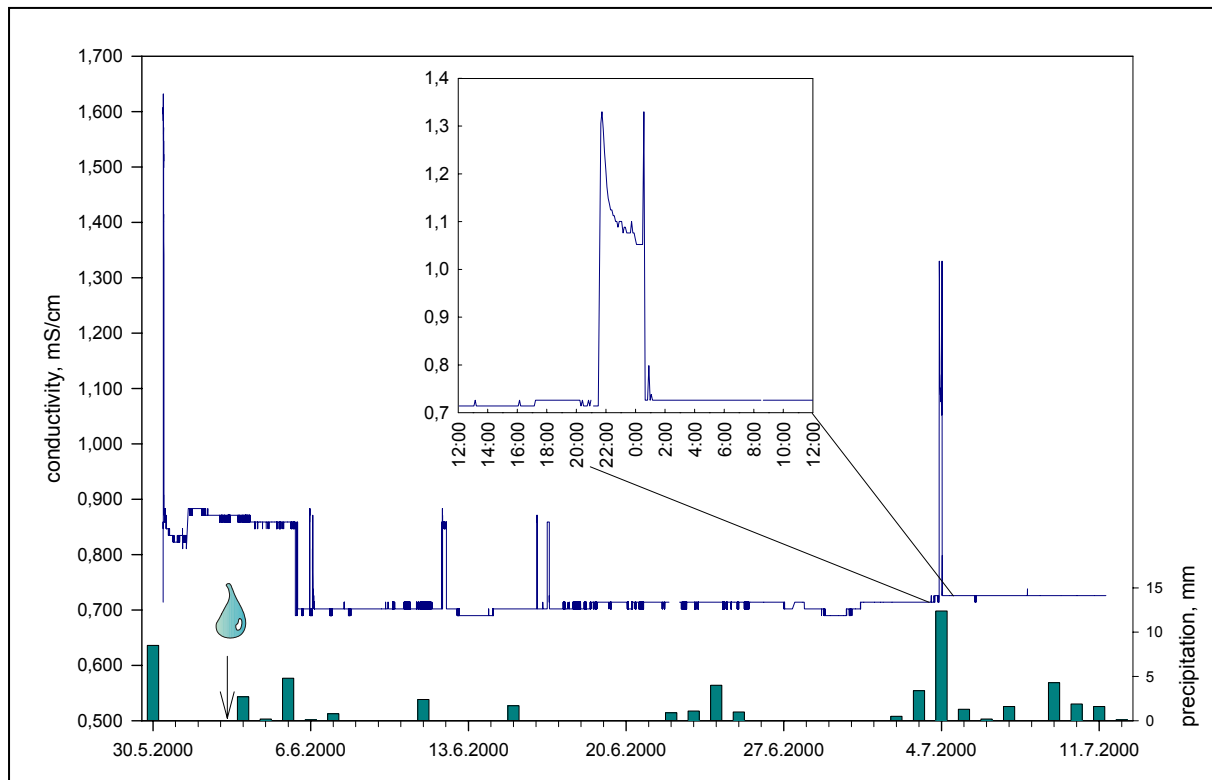

Fig. 2: Plot of precipitation (Siptenfelde station) and conductivity in the Fluor shaft. The arrow marks the time of the injection of the sodium chloride tracer into the Siptenfelde brook. Changes before June 6<sup>th</sup> are due to moving the conductivity probe upwards in the shaft by 5 m.

Unfortunately, within the Glasebach shaft, a very high contamination occurred, the reason for it being unclear. Even before the first tracer injection and in the blind sample, 1,000–6,000 spores were present. As there a bulk of unused filter nets from another tracer test was used, it might be possible, that these filter nets had been contaminated during their storage. Which of the peaks are due to contamination or to different flow paths, cannot be solved with the data available. Taking into account the complicated mine geometry between the Fluor and Glasebach shafts, the latter possibility cannot be fully excluded. Nevertheless, 10.5 days after tracer injection a clear peak with 25,000 spores exists and another one with 7,400 spores 3 days after tracer injection. Once again, the maximum is reached very quickly, whilst the peak is tailing out within 2 days. Between the injection point in the Fluor shaft and the detection point in the Glasebach shaft, the tracer had to travel 3.180 m at the shortest pathway. Taking into consideration the two peaks and the shortest travel distance, the mean effective velocity calculates to be 0.2–1.2 m min<sup>-1</sup>.

## Microspheres

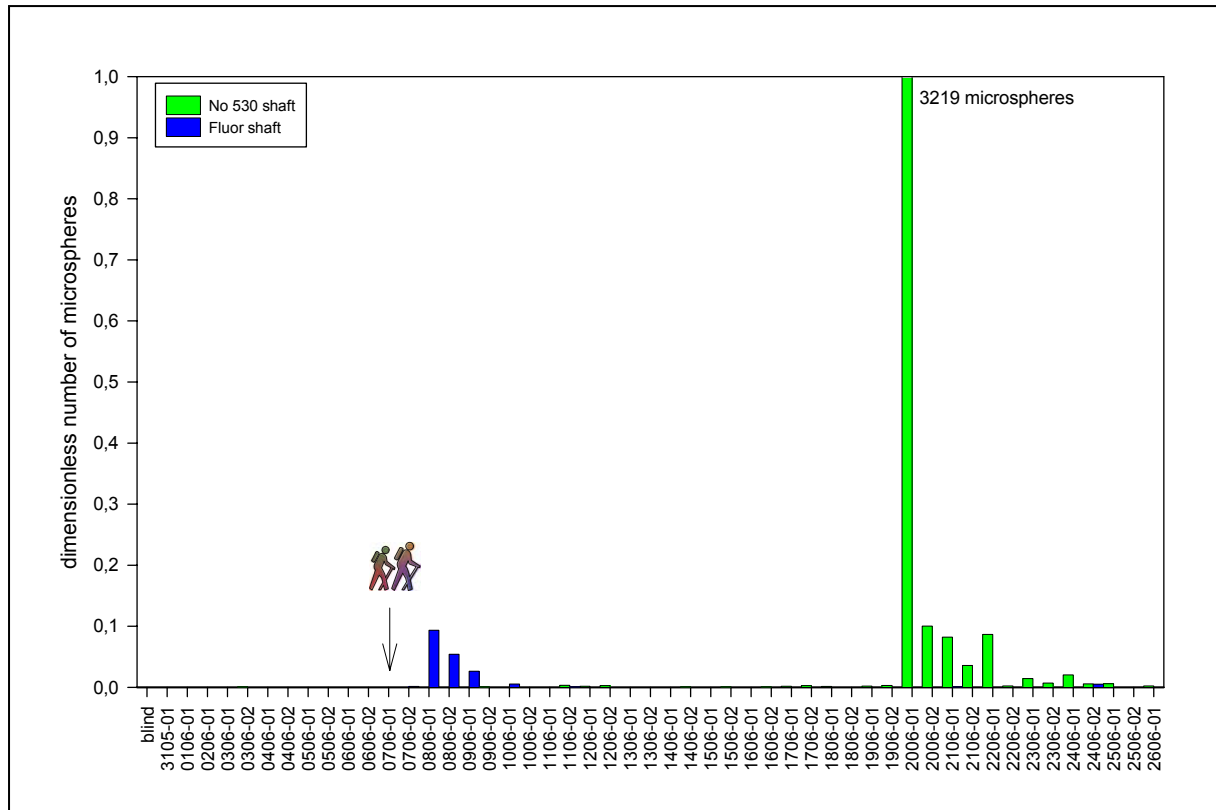

Fig. 3: Breakthrough curves of the microspheres detected at the Fluor shaft. (max.: 3,219 microspheres). Arrow marks time of tracer injection.

From the microspheres injected in the No 539, No 530, Fluor, and Glasebach shaft, only the microspheres from the No 530 and Fluor shaft could be detected. It cannot be excluded that the LydiAs lowered into the No 539 and Glasebach shaft did not open properly.

In the Fluor shaft, microspheres from the Fluor shaft and the No 530 shaft could be detected (Fig. 3). 1 day after the tracer injection, 220 microspheres from the deep part of the Fluor shaft could be detected at the shafts' outflow. As already observed, the peak sets in very quickly and tails out within 1.5 days. The other peaks of microspheres from the Fluor shaft are negligible. 13 days after tracer injection, 3,219 microspheres from the No 530 shaft reach the sampling point at the Fluor shaft. Still 2.5 days and 4 days later a significant tracer signal could be observed. Based on the shortest distances of 238 m and 1,773 m, the mean effective velocities are 0.1–0.2 m min<sup>-1</sup>.

Tab. 5: Mean effective velocity of mine water in the Straßberg mine. No tracer from No 539 shaft could be detected anywhere.

from	to	tracer	velocity $v_{\text{eff}}$	distance
No 530 shaft	Fluor shaft	microspheres	0.1 m min <sup>-1</sup>	1,773 m
No 530 shaft	Glasebach shaft	microspheres	0.3 m min <sup>-1</sup>	4,798 m
Fluor shaft	Fluor shaft	microspheres	0.2 m min <sup>-1</sup>	238 m
Fluor shaft	Fluor shaft	club moss spores	0.1 m min <sup>-1</sup>	238 m
Fluor shaft	Glasebach shaft	microspheres	0.3 m min <sup>-1</sup>	3,180 m
Fluor shaft	Glasebach shaft	club moss spores	0.2–1.2 m min <sup>-1</sup>	3,180 m
Siptenfelde brook	Fluor shaft	NaCl-brine	1.5 m min <sup>-1</sup>	2,250 m

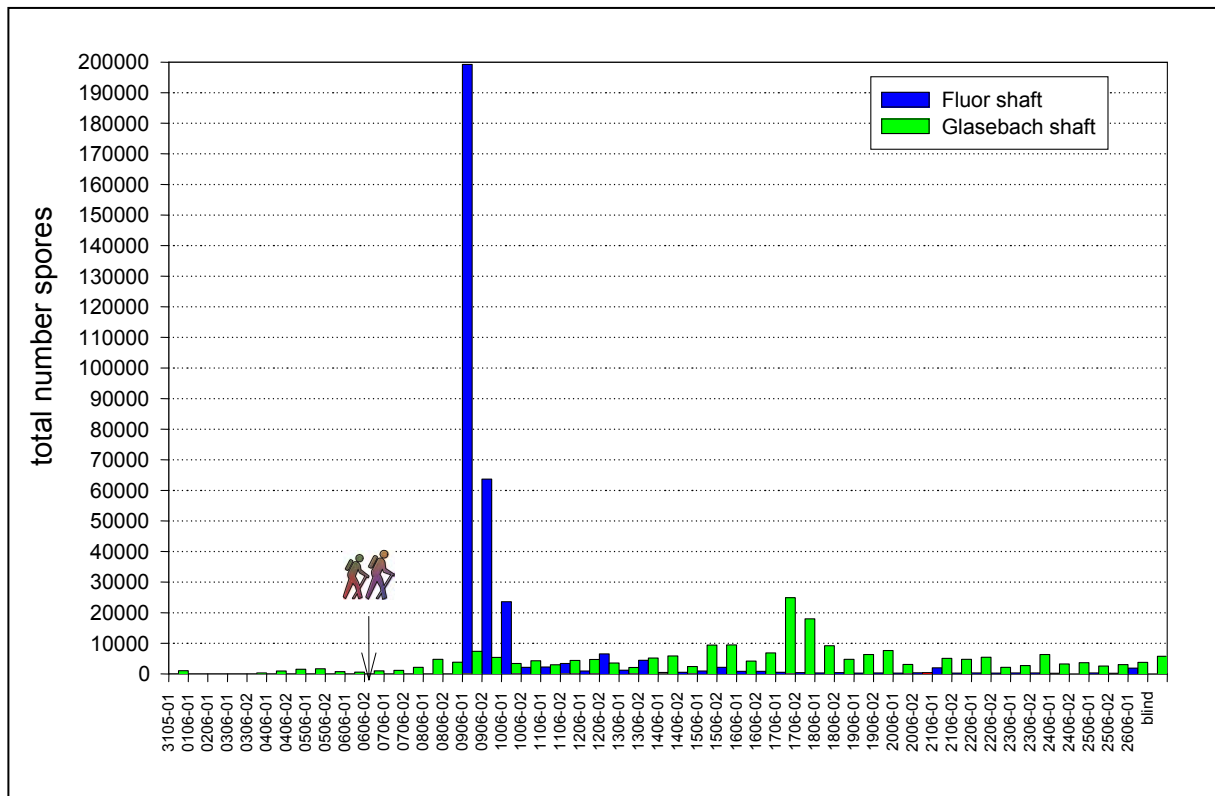

Fig. 4: Breakthrough curves of the club moss spores detected at the Fluor and Glasebach shafts. Arrow marks time of tracer injection. No spores were detected at the No 539 shaft. Noticeable amounts of spores at the Fluor shaft arrive 2.5 days and at the Glasebach shaft 11 days after tracer injection.

Only Microspheres from the No 530 shaft could be detected at the Glasebach shaft (Fig. 5). All the other microspheres, including those injected into the Glasebach shaft itself, could not be found abundant enough to draw useful conclusions. 13 days after tracer injection, 9,748 microspheres from No 530 shaft occurred at the sampling point Glasebach shaft. As already observed in the Fluor shaft, the peak tails out slowly and even 3 days later a significant amount of microspheres could be detected. As the distance between the No 530 and Glasebach shafts is 4,798 m, a mean effective velocity of  $0.3 \text{ m min}^{-1}$  calculates.

## Conclusions

All of the tracers positively injected into the 5 injection points, could be detected by at least one of the 4 sampling points. Therefore, both, the injection and sampling methods, proved to be suitable for the Straßberg mine. Unfortunately, the tracer test gave no results to the question, why the mine's total water budget increased by  $2 \cdot 10^6 \text{ m}^3$  after installing the 3-adit-system.

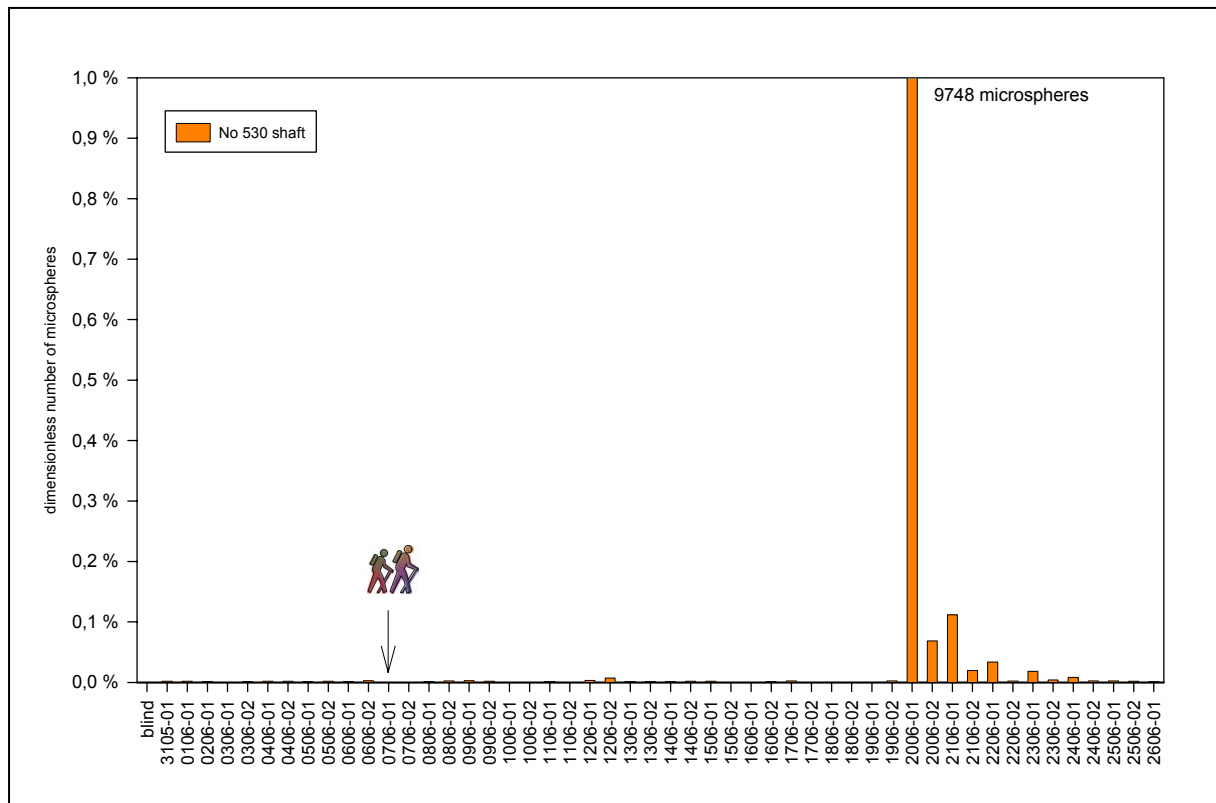

Fig. 5: Breakthrough curves of the microspheres detected at the Glasebach shaft (max.: 9,748 microspheres). Arrow marks time of tracer injection.

From the results it is clear now, that all parts of the mine are hydraulically well connected. Generally, the flow direction throughout the tracer test was from north to south, thus explaining the similar chemical composition of the mine water in the Fluor and Glasebach shafts. This was a new result, because previous to the tracer test, it was believed, that the general flow direction of the mine water was from south to north. Finally, under the current flow regime, with the 3-adit-system working, no stratification will be achieved again.

Furthermore, the sodium chloride tracer confirmed the assumption, that there is a connection between the Siptenfelde seepage and the mine. The breakthrough curves clearly show, that the hydraulic dispersion within the flow path through the partly unsaturated fissured aquifer and the mine's drifts and shafts is rather small and that the tracer is transported after rainfall events only. Because more than one third (39 %) of the injected sodium chloride tracer was recovered within the 6 weeks of the tracer test, it must be assumed that there is a good connection between the Siptenfelde seepage and the northern adit. Comparing the velocities of the microspheres arriving from the No 530 shaft ( $0.1\text{--}0.2\text{ m min}^{-1}$ ) and the sodium chloride tracer ( $1.5\text{ m min}^{-1}$ ), the transport from the Siptenfelde seepage into the mine (approx. 180 m) must be very fast.

Both tracers pass the dam in the northern adit or at least the fissured rock around it, without having problems. From the breakthrough curves, showing a small hydraulic dispersion, it is more likely, that the tracers pass a broken pipe in the dam, than the surrounding rock. Consequently, all the results show, that the dam is hydraulically ineffective.

Comparing the numbers of tracers arriving from the No 530 and Fluor shaft, the composition of the water leaving the Fluor and Glasebach shafts can be explained. Water leaving the Fluor shaft, is composed of water from the Brachmannsberg pit and the Straßberg pit whilst water leaving the Glasebach shaft consists of water from all three pits: the Brachmannsberg,

Straßberg and Glasebach pit. No water from the Glasebach pit flows north into the Straßberg pit and no water from the Straßberg pit flows north to the Brachmannsberg pit.

Finally, the results clearly proofed, that the modified injection and sampling techniques used for the Straßberg tracer test is a good means for hydrodynamic investigations in flooded mines.

## Acknowledgements

The authors would like to express their gratitude to Hans-Joachim Kahmann and Klaus Heinrich of BST Mansfeld GmbH and the GVV for their financial and personal support of the tracer test. We would also like to thank the staff of the BST Mansfeld, especially the Köhn family, at the Straßberg mine, who spent a lot of time taking care of us. Our colleagues at the TU Bergakademie Freiberg supported us whenever help was needed. This study had been financially supported by the BST Mansfeld, the DFG Graduate School “Geowissenschaftliche und Geotechnische Umweltforschung” (speaker: Univ.-Prof. Dr. B. Merkel) at the TU Bergakademie Freiberg and the EU Project PIRAMID (contract no. EVK1-CT-1999-00021). This paper expresses the views held by the authors and does not necessarily reflect those held by the BST Mansfeld, the GVV, or any authorities involved.

## Literature

- Aldous, P.J. & Smart, P.L. (1987): *Tracing Ground-Water Movement in Abandoned Coal Mined Aquifers Using Fluorescent Dyes*. *Ground Water* 26(2):172–178.
- Bartels, C. & Lorenz, E. (1993): *Die Grube Glasebach – ein Denkmal des Erz- und Fluoritbergbaus im Ostharz*. *Der Anschnitt* 45(4):144–158.
- Becker, M.W., Reimus, P.W. & Vilks, P. (1999): Transport and attenuation of carboxylate-modified latex microspheres in fractured rock laboratory and field tracer tests. *Ground Water* 37(3):387–395.
- Davis, M.W. (1994): *Identification and remediation of a mine flooding problem in Rico, Dolores County, Colorado with a discussion on the use of tracer dyes*. Colorado Geological Survey Open File Report 91-1:18.
- Goldbrunner, J.E., Ramspacher, P., Zojer, H., Zötl, J.G., Moser, H., Rauert, W. & Stichler, W. (1982): *Die Anwendung natürlicher und künstlicher Tracer in einem hochalpinen Magnesitbergbau*. *Beitr Geol Schweiz – Hydrol* 28(II):407–422.
- Käss, W. (1998): *Tracing Technique in Geohydrology*. Rotterdam: Balkema: 581.
- Kindermann, L. (1998): *Kontrolle geochemischer Parameter beim Wiedereinbau von Reststoffen in ein stillgelegtes Bergwerk*. *Wissenschaftliche Mitteilungen – Sonderheft 7*:196–201.
- Kuschka, E. & Franzke, H.J. (1974): *Zur Kenntnis der Hydrothermalite des Harzes*. *Z geol Wiss* 2(12):1417–1436.
- Kuyumcu, M. & Hartwig, H.J. (1998): *Aufgaben der GVV – Gesellschaft zur Verwahrung und Verwertung von stillgelegten Bergwerksbetrieben mbH*. *Bergbau* 49(1):18–22.
- McKay, L.D., Cumbie, D.H. & Harton, A.D. (1997): *Factors influencing colloid transport in fractured shale saprolite*. *Abstracts with Programs – Geological Society of America* 29(6):307–308.
- Mohr, K. (1978): *Geologie und Minerallagerstätten des Harzes*. Stuttgart: Schweizerbart: 388.
- Moline, G.R., Knight, C.R. & Ketcham, R. (1997): *Laboratory measurement of transport processes in a fractured limestone/shale saprolite using solute and colloid tracers*. *Abstracts with Programs – Geological Society of America* 29(6):370.

- Niehren, S. & Kinzelbach, W. (1998): Artificial colloid tracer tests – development of a compact on-line microsphere counter and application to soil column experiments. *Journal of Contaminant Hydrology* 35(1–3):249–259.
- Petrich, C.R., Storm, K.E., Ralston, D.R. & Crawford, R.L. (1998): Encapsulated cell bioremediation; evaluation on the basis of particle tracer tests. *Ground Water* 36(5):771–778.
- Rüterkamp, P. & Messer, J. (2000): *Untersuchungen zur hydraulischen und hydrochemischen Situation in den drei Teilrevieren der gefluteten Flussspatgrube Straßberg*. In: BST Mansfeld GmbH & Co KG Niederröblingen. Essen: Deutsche Montan Technologie GmbH: 46 (unpublished).
- Skowronek, E. & Zmij, M. (1977): *Określenie pochodzenia wody wypływającej zza obmurza szybu znakowaniem rodaminą B* [Determination of the Origin of Water Flowing Out from Behind a Shaft Lining Traced with Rhodamine B]. *Przeegl Gorn* 33(1):13–19.
- Turin, H.J. & Reimus, P.W. (1997): *Multi-component tracer testing in fractured tuff at the C-Wells complex, Yucca Mountain, Nevada*. Abstracts with Programs – Geological Society of America 29(6):369.
- Wolkersdorfer, Ch. (1996): *Hydrogeochemische Verhältnisse im Flutungswasser eines Uranbergwerks – Die Lagerstätte Niederschlema/Alberoda*. Clausthaler Geowissenschaftliche Dissertationen 50:1–216.
- Wolkersdorfer, Ch. (2000): *Multitracerversuch Straßberg/Harz*. In: BST Mansfeld GmbH & Co KG Niederröblingen. Freiberg: TU Bergakademie Freiberg: 30 (unpublished).
- Wolkersdorfer, Ch., Feldtner, N. & Trebušak, I. (1997a): LydiA – A new Method for tracing Mine Water. In: International Mine Water Association. *Mine Water and the Environment*. Ljubljana: Proceedings, 6th International Mine Water Congress, Bled, Slovenia: 43–55.
- Wolkersdorfer, Ch., Trebušak, I. & Feldtner, N. (1997b): Development of a Tracer Test in a flooded Uranium Mine using *Lycopodium clavatum*. In: *Kranjc A. Tracer Hydrology 97*, vol. 7. Rotterdam: Balkema: 377–385.
- Zhang, Y.-Z., Kemper, C., Bakke, A. & Haugland, R.P. (1998): *Novel Flow Cytometry Compensation Standards: Internally Stained Fluorescent Microspheres With Matched emission Spectra and Long-Term Stability*. *Cytometry* 33:244–248.

## Contact

Christian Wolkersdorfer  
TU Bergakademie Freiberg  
Lehrstuhl für Hydrogeologie  
Gustav-Zeuner-Str. 12  
09596 Freiberg/Sachsen, Germany  
Phone: +49/3731/39-3309; Fax: +49/3731/39-2720  
E-Mail: [c.wolke@wolkersdorfer.info](mailto:c.wolke@wolkersdorfer.info)  
<http://www.wolkersdorfer.info>



## **PASSIVE IN SITU REMEDIATION OF CONTAMINATED GROUNDWATER: PERMEABLE REACTIVE BARRIERS – PRBS**

*K.E. Roehl, Karlsruhe University, DE*

*Keywords: Water pollution, contaminated land, groundwater, remediation, permeable reactive barrier, treatment wall*

### **Abstract**

Passive in-situ groundwater remediation using permeable reactive barriers (PRBs) is a new and innovative technology. PRBs are subsurface constructions situated across the flow paths of contaminant plumes. The contaminants are removed from the groundwater flow by geochemical processes taking place in the reactive material of the barrier filling. Suitable materials for use as reactive components in PRBs are elemental iron, activated carbon, zeolites, iron oxides/oxyhydrates, phosphates, clay minerals, and others. The choice of reactive materials and retention mechanisms are dependent on the type of contamination to be treated by the barrier system.

The paper gives a brief overview of the application of PRBs for groundwater remediation. It is the intention of the author to encourage to further reading by giving a wide selection of references covering the meanwhile quite extensive literature in the field of PRB research and application.

### **Concept of Reactive Barriers**

Due to the large number of contaminated sites that require treatment, and in light of the incorporation of eastern European countries into the European Union, with their sometimes appalling ecological problems, there is an urgent need for cost-effective risk management. Risk management typically involves remediation technologies for the control of the contaminant source and/or the management of contaminants along the pathway (CLARINET, 2002). Objective is breaking the pollutant linkage between source and receptor (e.g., drinking water resources) by managing or breaking the pathway. Groundwater remediation schemes are widely used to achieve this objective, mainly based on active methods such as pump-and-treat techniques.

Passive groundwater remediation methods such as permeable reactive barriers (PRBs), as first developed in North America, have a high potential to reduce the remediation costs of contaminated shallow aquifers significantly and therefore contribute to the preservation of groundwater resources.

Permeable reactive barriers (Fig. 1) are defined by the U.S. Environmental Protection Agency as “passive in situ treatment zones of reactive material that degrades or immobilizes contaminants as ground water flows through it. PRBs are installed as permanent, semi-permanent, or replaceable units across the flow path of a contaminant plume. Natural gradients transport contaminants through strategically placed treatment media. The media degrade, sorb, precipitate, or remove chlorinated solvents, metals, radionuclides, and other pollutants” (EPA,

1999). The substantial deviation from common remediation techniques is the approach to treat the contaminant plume and not its source (Schad & Grathwohl, 1998). The targeted contaminants are removed from the groundwater flow by geochemical processes such as surface adsorption, chemical bonding, redox reactions, and/or precipitation (Vidic & Pohland, 1996, EPA, 1998).

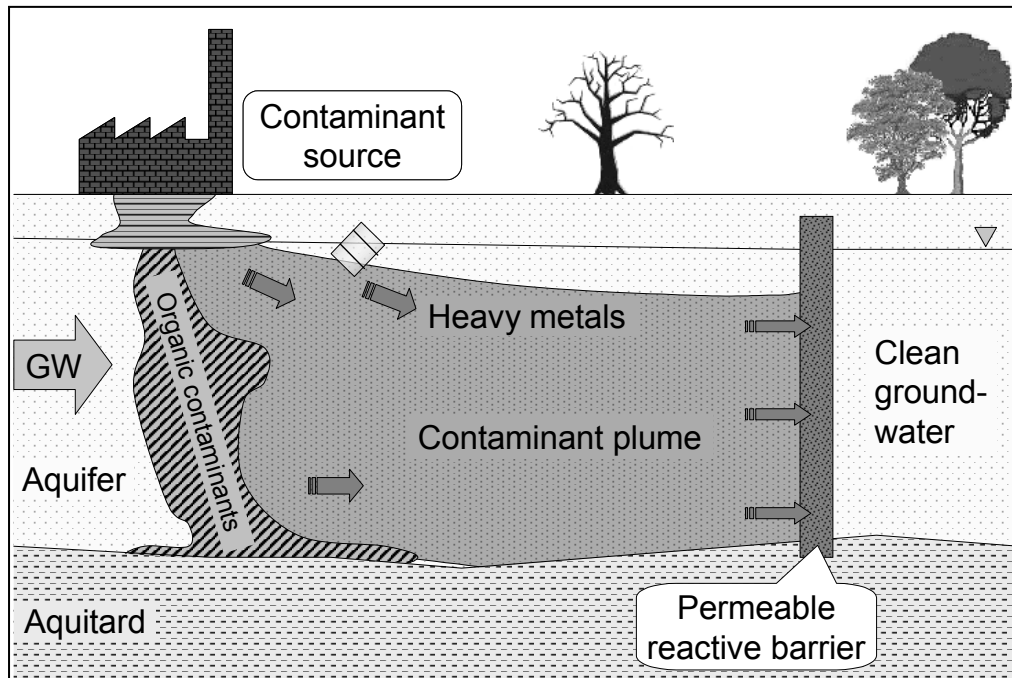

Fig. 1: Schematic depiction of the PRB concept (GW = groundwater flow direction).

The permeable reactive barrier technology appears to be a promising approach to effective groundwater remediation even in complex cases where traditional 'pump-and-treat' methods and/or microbiological techniques have proved unsuccessful (e.g., heavy metals being slowly leached from a contamination source; PAH with low bio-availability; contamination of heterogeneous sediments). Although the use of PRBs is limited to certain site conditions, in places where the application is feasible they appear to be a good choice with good acceptance by end-users, especially in urban environment and built-up areas. Reasons for this can be seen in, e.g., little land use, little visibility, no additional impact on the landscape by equipment such as containers, water tanks, pumps, or by noise from running machines etc.

Only a small number of pilot-scale and full-scale installations exist today, mainly located in the United States (Morrison, 1998, EPA, 1999) and Germany (Birke et al., 2003), and so practical experience with such systems is limited. At present it is unclear how reactive barriers may be authorised as an alternative remediation process as little is known about the long-term behaviour of such systems. Therefore, as a relatively new approach with only little information available about its long-term stability, permeable reactive barriers are not well accepted yet in Europe. Further development of this technique is only recently pushed forward by a number of research groups and institutions. Besides the development of new barrier technologies like the introduction of new reactive materials and barrier construction methods, more information is needed especially on the long-term behaviour of the reactive barriers and on the mechanisms that might affect the stability of the remediation success during barrier life-time.

## Design and Construction Considerations

The two main types of PRBs used in field applications are:

- € continuous reactive barriers enabling a flow through its full cross-section, and
- € 'funnel-and-gate' systems (Starr & Cherry, 1994) in which only special 'gates' are permeable for the contaminated groundwater.

The continuous PRB configuration is characterised by a single reactive zone installed across the contaminant plume, while the 'funnel-and-gate' system consists of one or more permeable gates placed in an impermeable wall that cuts through the plume and directs the contaminated water towards the gates (Fig. 2).

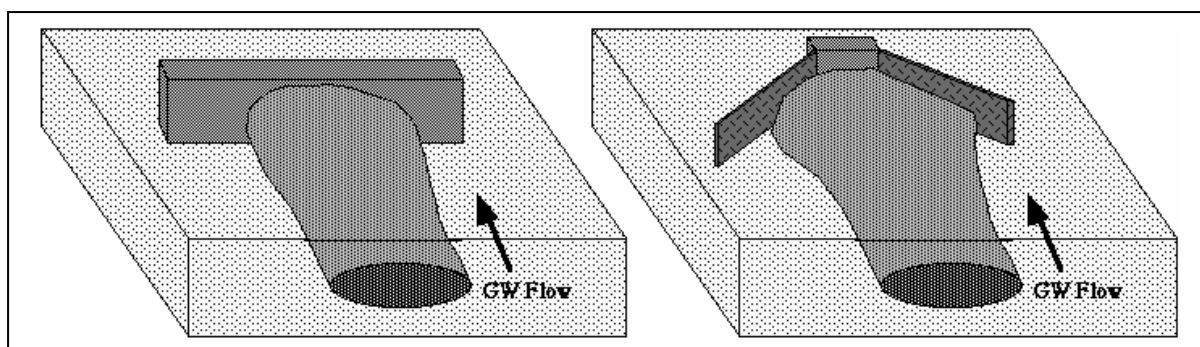

Fig. 2: Basic types of PRB configuration; (a) continuous wall, (b) 'Funnel-and-Gate' system (source: <http://www.powellassociates.com/sciserv/Perm.barrier.main.html>).

Continuous barriers can be emplaced by trenching or other conventional cut-off wall construction methods (Meggyes & Simon, 2000). In 'funnel-and-gate' systems, the funnel elements can also be installed using cut-off wall techniques, namely sheet piling, slurry trenching, mandrel-based emplacement, grouting and deep soil mixing. Numerous options exist for the design of the gates of a 'funnel-and-gate' system. In most cases they consist of reactors installed as simple sheet piling boxes (caisson) or large-diameter drill holes filled with the reactive material. The engineering of PRBs is discussed by, e.g., Gavaskar et al. (1998), Gavaskar (1999), Day et al. (1999) and Meggyes & Simon (2000).

The choice between the two configuration options depends on the hydrogeological characteristics of the site, the technical applicability of the barrier placement, and on the cost of the reactive material. When a high-cost reactive material is used, the 'funnel-and-gate' configuration is preferable since the reactive zone requires less material. If a cheap material can be used, it is more profitable to avoid the construction of the impermeable side-walls by employing a continuous barrier.

Further applications of the PRB concept are imaginable which modify the initial approaches. The containment of a contaminated site can be coupled with 'gates' comprising reactors treating contaminants leached from the soil by infiltrating rain water. Contaminated surface and ground water from polluted sites can be collected in trenches or drains and treated in an underground reactor or system of underground reactor cells before being discharged into a nearby river or into a regular sewage system. Another option using in-situ reactive zones is the so-called GeoSiphon system which utilises gravitational hydraulic gradients in pipes to draw contaminated groundwater through a treatment reactor installed in a well (Phifer et al., 2002).

PRBs are also suitable to implement groundwater remediation schemes not only in typical industrial areas but also in residential areas or on other sites that are typical in urban areas

such as shopping centres, parking lots, industrial parks etc. In all cases a number of factors have to be considered and taken care of during planning and installation of a PRB system:

- € property boundaries;
- € underground utilities such as fresh water and sewage water pipes, gas lines, cables etc. have to be located and possibly diverted;
- € the construction of the PRB will possibly lead to disruption of site activities;
- € dewatering of the excavation pit;
- € disposal of potentially contaminated water (dewatering) and soil (excavation pit);
- € material placement requires careful logistics and on-site management (e.g., quality control, homogenous filling of the reactors, prevention of dust etc.);
- € human health and safety issues;
- € unforeseen conditions (e.g., bombs).

### Reactive materials and contaminant attenuation processes

The selection of the reactive material to be used in a PRB is depended on the type of contamination and the remediation approach (contaminant removal mechanism). In general, contaminants can be removed from polluted water by the following processes:

- € Degradation: Application of chemical or biological reactions that lead to the decomposition of contaminants and the formation of harmless compounds which are either retained in the barrier or released downstream.
- € Precipitation: Immobilisation of contaminants by formation of insoluble compounds (minerals). The immobilised contaminants remain in the barrier material.
- € Sorption: Immobilisation of contaminants by adsorption or complex formation. The immobilised contaminants remain in the barrier material.

In most cases, the effect of these processes on the contaminant removal can not be completely distinguished and a combination of processes is utilised. A review on reactive materials suitable for use in PRBs for the removal of inorganic and organic compounds from groundwater is available in a number of publications (Rael et al., 1995, Baker et al., 1998, Gavaskar et al., 1998, Scherer et al., 2000, Simon & Meggyes, 2000, Roehl et al., 2001, Xenidis et al., 2002), also with special respect to mine waters (Blowes et al., 2000, Younger, 2000, Wolkersdorfer & Younger, 2002), and will not be repeated here. The up to date most widely used approaches for PRBs can be grouped into two categories: Reductive barriers and sorption barriers.

The best known reactive material is granular zero-valent iron (elemental iron, Fe<sup>0</sup>). An extensive review on the iron technique has been given recently by Tratnyek et al., (2003). The widespread use of elemental iron is attributed to its ability to act as a strong reducing agent in groundwater causing abiotic reductive degradation of organic substances such as chlorinated hydrocarbons and some aromatics and reductive immobilisation of some inorganic compounds such as chromium, nickel, lead, uranium, sulphate, nitrate, phosphate, arsenic, molybdenum, among others. Another reductive mechanism, particularly important for the treatment of often acidic mine waters, is bacterial sulphate reduction as supported by organic materials such as compost, wood chips, sawdust, etc. (Benner et al., 1999, Blowes et al., 2000, Waybrant et al., 2002). In this approach the reduction of sulphate to sulphide is utilised for the removal of metals from contaminated water by precipitation as sulphides. The simultaneous production of alkalinity and rise in pH increases the efficiency of the system by additional precipitation of metals as hydroxides.

Due to the high efficiency of the amalgamation process in removing  $\text{Hg}^{2+}$  from aqueous solution, the use of elemental copper shavings ( $\text{Cu}^0$ ) for the removal of mercury from contaminated water is suggested by Huttenloch et al. (2003), employing a sequential system of mercury amalgamation followed by the removal of copper mobilized from the shavings by an ion exchanger such as zeolites.

Sorption barriers are PRBs utilising retention mechanisms that lead to a fixation of the target contaminants to the matrix of the reactive material (Roehl et al., 2001). A large number of materials that are able to sorb and trap certain contaminants, and therefore immobilise them from the groundwater, are imaginable. The efficiency of the immobilisation mechanisms in terms of its sorption capacity, selectivity, reaction kinetics and bonding strength is of great importance. The target contaminants have to be fixed to the reactive material in a way that they are not easily remobilised and subsequently released to the groundwater. The reactive materials need to be available in a form that ensures a sufficiently high hydraulic permeability and exhibit a non-harmful behaviour towards the environment.

The choice of reactive materials and retention mechanisms are dependent on the type of contamination to be treated by the barrier system. Possible materials for the use as reactive components in sorption barriers are activated carbon (Sontheimer et al., 1988, Schad & Grathwohl, 1998, Han et al., 2000, Tiehm et al., 2000), zeolites (e.g., Ouki et al., 1993, Cantrell et al., 1994, Pansini, 1996, Czurda, 1999, Anderson, 2000, Czurda & Haus, 2002, Park et al., 2002), iron oxides/oxyhydrates (Morrison & Spangler, 1992, Morrison et al., 1995a,b, Moyes et al., 2000), phosphate minerals (Ma et al., 1993, Xu & Schwartz, 1994, Fuller et al., 2003), and surface-modified minerals such as organophilic zeolites (Haggerty & Bowman, 1994, Cadena & Cazares, 1996, Bowman, 1999, Huttenloch et al., 2001), diatomites (Huttenloch et al., 2001) or clays (Smith & Jaffe, 1994, Smith & Galan, 1995, Lundie & McLeod, 1997, Zhu et al., 2000).

A wide selection of low-cost sorbents including mineralic and non-mineralic materials, such as bark, chitin, chitosan, lignin, seaweed and algae, xanthates, zeolites, clay, fly-ash, peat, moss, etc., for the sorption of heavy metals is discussed and evaluated by Bailey et al. (1999). The authors conclude from their literature review that for Pb, Cr, Cd, and Hg the highest sorption capacities were found for chitosan, zeolites, lignin, and seaweed.

Activated carbon is to date the most widely used material in sorption barriers. The adsorption of organic compounds to activated carbon is a well established method for on-site or off-site treatment of polluted water. In granular form, activated carbon appears to be highly suitable for the use in permeable barriers. Due to its large specific surface area (around  $1000 \text{ m}^2/\text{g}$  by  $\text{N}_2$ -BET is a typical value) and the presence of different types of surface functional groups, activated carbon shows a high adsorption capacity for many organic and inorganic contaminants (Sontheimer et al., 1988, Grathwohl & Peschik, 1997, Schad & Grathwohl, 1998, Han et al., 2000, Tiehm et al., 2000, Schad et al., 2001, Kraft & Grathwohl, 2003).

Phosphate minerals such as hydroxyapatite and biogenic apatite (e.g., fishbone) enable the removal of metals from contaminated water by sorption and precipitation or a combination of both mechanisms, as described for lead (Ma et al., 1993, Xu & Schwartz, 1994, Admassu & Breese, 1999), antimony (Leyva et al., 2001) and uranium (Arey et al., 1999).

Artificial materials such as, e.g., tailored polymers, may facilitate highly contaminant-selective sorption processes. PANSIL is a polyacrylamidoxime resin, derived from polyacrylonitrile, coated onto the surface of quartz sand, designed to sequester uranium (VI) from contaminated groundwater (Bryant et al., 2003). The advantage of PANSIL is that it is quite selective towards the uranyl ion, is available in a granular and durable form (s. Fig. 3) which is important for use in a PRB system, and does not have any side-effects on the groundwater composition or the geochemical conditions in the barrier avoiding secondary effects such as coating or clogging of the reactive matrix.

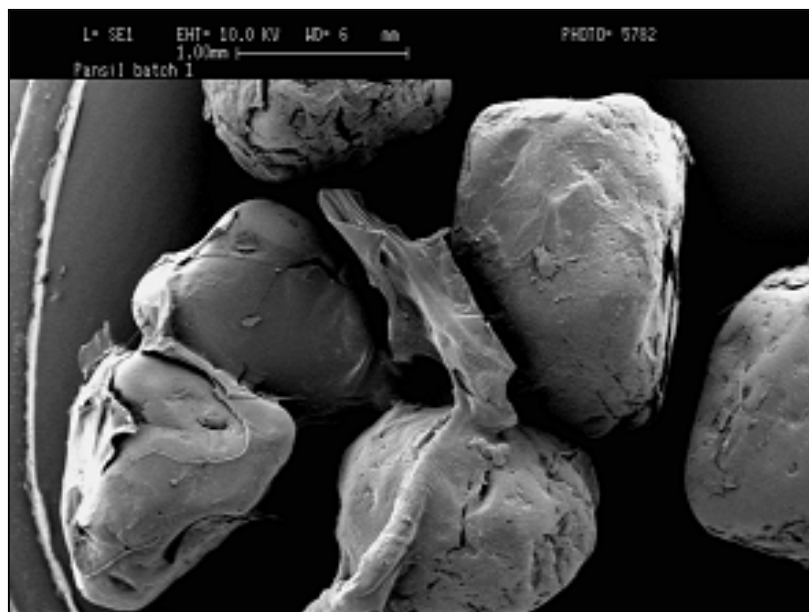

Fig. 3: Electron micrograph of PANSIL, a reactive material consisting of quartz sand coated with a polymer for the removal of uranium from contaminated groundwater (source: Bryant et al., 2003).

Other materials bear some potential for use in special cases, such as organophilic zeolites and diatomites with silanol surface (Huttenloch et al., 2001) and organo-clays (Ake et al. 2001).

The choice of material needs to be based on the following criteria (Gavaskar et al., 1998):

- € Reactivity: The reactivity of the material is quantitatively evaluated by the required residence time or the reaction rate constant. It is desirable to have low residence times and high reaction rates in order to keep the barrier's thickness within acceptable limits.
- € Stability: The material is expected to remain active for long periods of time because its replacement is not easily achieved. Stability in changes of pH, temperature, pressure and antagonistic factors is also required.
- € Availability and cost: The amount of reactive material required for the construction of a reactive barrier is large enough and therefore it is essential to have considerable quantities in low prices.
- € Hydraulic performance: The hydraulic conductivity of the material depends on its particle size distribution and its value must be greater or equal to the value of the surrounding soil. However, an optimum particle size that would provide appropriate permeability and sufficient contact time must be determined.
- € Environmental compatibility: It is important that the reactive media does not form any by-products when reacting with the contaminants and that it is not a source of contamination itself by solubilisation or other mobilisation mechanisms.
- € Safety: Handling of the material should not generate any risks for the workers health.

Furthermore, for the planning of a PRB system the characteristics of the contaminated site need to be investigated. Crucial parameters include the hydraulic setting, the types and concentrations of contaminants, the total mass of contaminants, and the groundwater composition.

Feasibility studies are necessary involving the following steps:

- € Choice of suitable remediation approach (contaminant removal mechanism) and reactive material.
- € Column experiments (and other experiments quantitatively describing the contaminant attenuation capability of the reactive material).
- € Estimation of required residence time.
- € Calculation of reactive zone thickness.

In PRBs, the residence time of the contaminant in the reactive material must be longer than the time that is needed to establish the reaction equilibrium. Therefore, the reaction rate of the sorption process employed in the barrier must be sufficiently high compared to the flow velocity of the contaminated groundwater through the barrier. Following these considerations, the thickness of the reactive barrier can be calculated from the groundwater flow velocity in the barrier and the required residence time (Gavaskar et al., 1998):

$$b = v \times t_R$$

where  $b$  is the barrier thickness (m),  $v$  the flow velocity in the barrier (m/s), and  $t_R$  the residence time (s) required.

### Geochemistry of reactive barriers

Especially in reductive barriers, the geochemical conditions inside the reactive zone and partly also in the surrounding soil experience significant changes. Considering an iron barrier consisting of an elemental iron filling and two pea gravel layers (up-gradient/down-gradient) at the interface soil/iron, the following effects are to be expected based on geochemical basic knowledge and practical experience:

- € Up-gradient aquifer: Groundwater composition and geochemical conditions 'normal' according to site; high contaminant concentration.
- € Up-gradient pea gravel: Same as in the soil, but beginning influence by the effects caused by the iron; contaminant concentration already decreased to some extent.
- € Iron filling: Contaminant concentration decreased to target value.  $\text{Fe}^{2+}$  concentration and pH significantly increased, with pH up to 11–12. Formation of  $\text{H}_2$  gas. Strong decrease of  $\text{Ca}^{2+}$ , alkalinity, free oxygen, nitrate and sulphate. Consequently, formation of precipitates such as  $\text{CaCO}_3$ ,  $\text{FeCO}_3$ ,  $\text{Fe}(\text{OH})_2$ ,  $\text{Mg}(\text{OH})_2$ ,  $\text{FeS}$ , and other secondary mineral phases in the treatment zone.
- € Down-gradient pea gravel/aquifer: Dependent on the buffer capacity of the soil, especially the carbonate content, and the mixing with water from surrounding areas transition of the 'extreme' values as created in the iron filling back to 'normal' values for pH, Eh, dissolved oxygen and most of the other groundwater constituents.

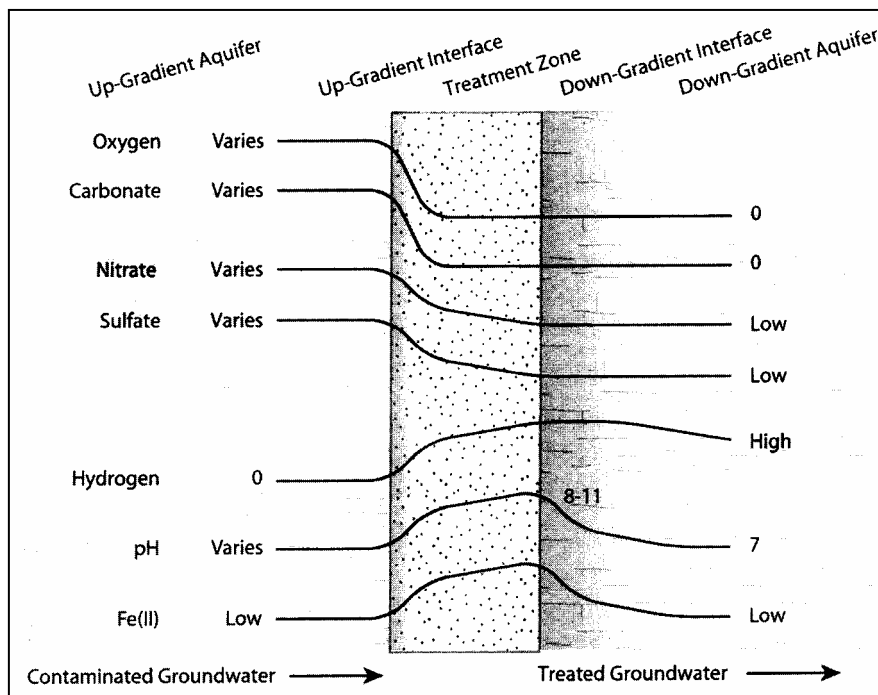

Fig. 4: Schematic cross-section of an iron PRB, showing the basic geochemical processes (source: Tratnyek et al., 2003).

The processes inside a PRB determine to a great extent the long-term performance of the system and the barrier lifetime. Studies on the long-term performance of PRB systems are reported by, e.g., O'Hannesin & Gillham (1998), Mackenzie et al. (1999), McMahon et al. (1999), Puls et al. (1999), Vogan et al. (1999), Blowes et al. (2000), Farrell et al. (2000), Phillips et al. (2000), Yabusaki et al. (2001), Kraft & Grathwohl (2003), Morrison (2003) and Sivavec et al. (2003). According to these sources, processes that might adversely affect the long-term efficiency of a permeable reactive barrier are: Coatings on the surface of the reactive material caused by precipitation, formation of secondary mineral phases, or iron corrosion ('rust').

≠ Clogging of the pore space caused by precipitation, formation of secondary mineral phases, production of bio-mass, or formation of gases bubbles (such as hydrogen gas in iron barriers).

≠ Consumption of the reactivity caused by exhaustion of sorption capacity or dissolution of the reactive material.

Despite these possible processes, to date the effect of mineral precipitation in iron PRBs on their system hydraulics porosity, hydraulic conductivity and on the iron reactivity has been found to be small (Mackenzie et al., 1999, Vogan et al., 1999). The study of the long-term behaviour of the reactive matrix components in PRBs requires to determine possible ageing mechanisms and to quantify the kinetics of the alteration processes. A possibility to do this is accelerated testing. The most important issue in designing accelerated testing methods is understanding the factors influencing the hydrogeochemical system. Design and implementation of accelerated testing procedures is a very complex task because slight changes in the initial conditions of a system can result in dramatic changes in physical, chemical and biological settings.



## Application

The number of full-scale field installations of PRBs increased significantly over the past years, almost exclusively in Northern America and Europe. More than 50 % of all projects are based on the elemental iron technology (EPA,2002).

In Germany, 11 pilot-scale and full-scale PRBs exist or are in the process of being implemented. Of these projects, 7 are based on elemental iron, sometimes with supplemental techniques, 3 on granular activated carbon, and 1 on palladium-modified zeolites. A good deal of information on the PRB sites in Germany can be found on the website of the German Permeable Reactive Barrier Network "RUBIN" which also features an extensive English language section (<http://www.rubin-online.de/>). With a few exceptions (e.g., Ebert et al., 1999, Klein & Schad, 2000, Birke et al., 2003, Ebert et al., 2003), there is to date relatively little published information available on the functioning and success of the German PRB systems.

## Outlook

The PRB technology appears to be a promising approach for integrated management in the area of polluted groundwater, contaminated sites, brownfields etc. Therefore, the question whether PRBs are the solution to our groundwater contamination problems is raised quite often. To answer this question, it is important to reconsider the following points:

- € What is the basic concept?
- € What are the potential applications?
- € What are the characteristics of the contaminated sites?
- € What are the methods available?

These are the same questions and considerations to be addressed when dealing with any other remediation option. The PRB technology is not appropriate for all cases of groundwater contamination, just as other methods are not universally applicable. The decision on whether to implement a PRB system or another remediation method is case-specific and depends mainly on the comparison of feasibility and costs.

Not all the PRBs installed in recent years are true success stories, a fact that can be deduced especially from the lack of publicly available information in a number of cases of pilot-scale and full-scale installations. Most problems appear to be related to the system hydraulics while the geochemistry of the contaminant attenuation process and the reactive material are actually functioning as predicted. The hydraulic functioning of a PRB relies to great extent on the understanding of the local and regional aquifer systems, the planning (hydraulic modelling) of the PRB system to be installed, and the quality of the construction work (Parbs et al., 2003). Therefore, future improvement of the PRB technology needs to address these issues. Other fields of advancing the PRB technology are the study of new and innovative materials targeting specific contaminants, and the combination of PRBs with other remediation technologies such as bioremediation (Werner, 1998, Scherer et al., 2000, Tiehm et al., 2000) or electrokinetics (Ho et al., 1995, Chew & Zhang, 1998, Czurda & Haus, 2002).

## References

- Admassu, W. & Breese, T. (1999): *Feasibility of using natural fishbone apatite as a substitute for hydroxyapatite in remediating aqueous heavy metals*. J. Haz. Mat., B69: 187–196.
- Ake, C.L., Mayura, K., Huebner, H., Bratton, G.R. & Phillips, T.D. (2001): *Development of porous clay-based composites for the sorption of lead from water*. J. Toxicol. Environ. Health, Part A, 63: 459–475.
- Anderson, M.A. (2000): *Removal of MTBE and other organic contaminants from water by sorption to high silica zeolites*. Environ. Sci. Technol., 34: 725–727.
- Arey, J.S., Seaman, J.C. & Bertsch, P.M. (1999): *Immobilization of Uranium in Contaminated Sediments by Hydroxyapatite Addition*. Environ. Sci. Technol., 33: 337–342.
- Bailey, S.E., Olin, T.J., Bricka, R.M. & Adrian, D.D. (1999): *A review of potentially low-cost sorbents for heavy metals*. Wat. Res., 33: 2469–2479.
- Baker, M.J., Blowes, D.W. & Ptacek, C.J. (1998): *Laboratory development of permeable reactive mixtures for the removal of phosphorus from onsite wastewater disposal systems*. Environ. Sci. Technol., 32: 2308–2316.
- Benner, S.G., Blowes, D.W., Gould, W.D., Herbert Jr., R.B. & Ptacek, C.J. (1999): *Geochemistry of a Permeable Reactive Barrier for Metals and Acid Mine Drainage*. Environ. Sci. Technol., 33: 2793–2799.
- Birke, V., Burmeier, H. & Rosenau, D. (2003): *Design, Construction and Operation of Tailored Permeable Reactive Barriers*. In: Prokop, G., Bittens, M., Cofalka, P., Roehl, K.E., Schamann, M. & Younger, P. (eds.), *Summary Report of the 1st IMAGE-TRAIN Advanced Study Course "Innovative Groundwater Management Technologies"*. Tübinger Geowissenschaftliche Arbeiten (TGA), C68: 64–94; Tübingen.
- Blowes, D.W., Ptacek, C.J., Benner, S.G., McRae, C.W.T., Bennett, T.A. & Puls, R.W. (2000): *Treatment of inorganic contaminants using permeable reactive barriers*. Cont. Hydrol., 45: 123–137.
- Bowman, R.B. (1999): *Pilot-Scale Testing of a Surfactant-Modified Zeolite PRB*. EPA Ground Water Currents, EPA 542-N-99-002, 3–4.
- Bryant, D.E., Stewart, D.I., Kee, T.P. & Barton, C.S. (2003): *Development of a Functionalized Polymer-Coated Silica for the Removal of Uranium from Groundwater*. Environ. Sci. Technol., 37: 4011–4016.
- Cadena F. & Cazares, E. (1996): *Use of organozeolites for the removal of organic contaminants from water*. In: Sahwney, B. (ed.), *Organic Pollutants in the Environment, CMS Workshop Lectures*, 8: 69–94. Clay Minerals Society, Boulder.
- Cantrell, K.J., Martin, P.F. & Szecsody, J.E. (1994): *Clinoptilolite as an in-situ permeable barrier to strontium migration in ground water*. In: Gee, G.W. & Wing, N.R. (eds.), *In-Situ Remediation Scientific Basis for Current and Future Technologies, 33rd Hanford Symposium*, Columbus 1994.
- Chew, C.F. & Zhang, T.C. (1998): *In-situ remediation of nitrate-contaminated ground water by electrokinetics/iron wall processes*. Wat. Sci. Tech., 38: 135–142.
- CLARINET (2002): *Remediation of Contaminated Land Technology Implementation in Europe. Report of the "Contaminated Land Rehabilitation Network for Environmental Technologies" (CLARINET)*, 174 p. – [available at <http://www.clarinet.at>]
- Czurda, K. (1999): *Reactive walls with fly ash zeolites as surface active components*. In: Kodama, H., Mermut, A.R. & Torrance, J.K. (eds.), *Clays for our Future, Proc. 11th Int. Clay Conf., Ottawa, Canada, June 1997*: 153–156; Ottawa.
- Czurda, K. & Haus, R. (2002): *Reactive barriers with fly ash zeolites for in situ groundwater remediation*. Appl. Clay Sci., 21: 13–20.
- Day, S.R., O'Hannesin, S.F. & Marsden, L. (1999): *Geotechnical techniques for the construction of reactive barriers*. J. Haz. Mat., 67: 285–297.

- Ebert, M., Möller, W. & Wegner, M. (1999): *R & D Project: Permeable reactive barrier (PRB) in Rheine – latest results*. *altlasten spektrum*, 2/99: 105–112.
- Ebert, M., Wegner, M., Parbs, A., Plagentz, V., Schäfer, D., Köber, R. & Dahmke, A. (2003): *Prognostizierte und tatsächliche Langzeitstabilität von Fe(0)-Reaktionswänden – Am Beispiel der Reaktionswand am Standort Rheine nach 5-jähriger Betriebszeit*. *Grundwasser*, 3/2003: 157–168.
- EPA (1998): *Permeable Reactive Barrier Technologies for Contaminant Remediation*. U.S. EPA Remedial Technology Fact Sheet, EPA 600/R-98/125: 102 p.
- EPA (1999): *Field Applications of In Situ Remediation Technologies: Permeable Reactive Barriers*. U.S. EPA Remedial Technology Fact Sheet, EPA 542-R-99-002: 122 p.
- EPA (2002): *Field Applications of In Situ Remediation Technologies: Permeable Reactive Barriers*. U.S. Environmental Protection Agency, 30 p.
- Farrell, J., Kason, M., Melitas, N. & Li, T. (2000): *Investigation of the long-term performance of zero-valent iron for reductive dechlorination of trichloroethylene*. *Environ. Sci. Technol.*, 34: 514–521.
- Fuller, C.C., Bargar, J.R. & Davis, J.A. (2003): *Molecular-Scale Characterization of Uranium Sorption by Bone Apatite Materials for a Permeable Reactive Barrier Demonstration*. *Environ. Sci. Technol.*, 37: 4642–4649.
- Gavaskar, A.R. (1999): *Design and construction techniques for permeable reactive barriers*. *J. Haz. Mat.*, 68: 41–71.
- Gavaskar, A.R., Gupta, N., Sass, B.M., Janosy, R.J. & O'Sullivan, D. (1998): *Permeable Barriers for Groundwater Remediation*. Batelle Press, Columbus, 176 p.
- Grathwohl, P. & Peschik, G. (1997): *Permeable Sorptive Walls for Treatment of Hydrophobic Organic Contaminant Plumes in Groundwater*. In: *Proc. Int. Containment Technology Conf., February 1997, St. Petersburg, Florida, USA, Conference: 711–717*.
- Haggerty, G.M. & Bowman, S. (1994): *Sorption of Chromate and other inorganic anions by organozeolite*. *Environ. Sci. Technol.*, 28: 452–458.
- Han, I., Schlautman, M.A. & Batchelor, B. (2000): *Removal of hexavalent chromium from groundwater by granular activated carbon*. *Wat. Env. Res.*, 72: 29–39.
- Ho, S.V., Sheridan, P.W., Athmer, C.J., Heitkamp, M.A., Brackin, J.M., Weber, D. & Brodsky, P.H. (1995): *Integrated In Situ Soil Remediation Technology, The Lasagna Process*. *Environ. Sci. Technol.*, 29, 2528–2534.
- Huttenloch, P., Roehl, K. E. & Czurda, K. (2001): *Sorption of Nonpolar Aromatic Contaminants by Chlorosilane Surface Modified Natural Minerals*. *Environ. Sci. Technol.*, 35: 4260–4264.
- Huttenloch, P., Roehl, K.E. & Czurda, K. (2003): *Use of Copper Shavings To Remove Mercury from Contaminated Groundwater or Wastewater by Amalgamation*. *Environ. Sci. Technol.*, 37: 4269–4273.
- Klein, R. & Schad, H. (2000): *Results from a full scale funnel-and-gate system at the Beka site in Tübingen (Germany) using zero-valent iron*. In: *Proc. ConSoil 2000*, 18–22 September 2000, Leipzig, Germany: 917–923; Thomas Telford Publ., London.
- Kraft, S. & Grathwohl, P. (2003): *Untersuchungen zum Langzeiteinsatz der In-situ-Aktivkohlefiltration zur Entfernung von organischen Schadstoffen aus Grundwasser*. *Grundwasser*, 1/2003: 23–31.
- Leyva, A.G., Marrero, J., Smichowski, P. & Cicerone, D. (2001): *Sorption of Antimony onto Hydroxyapatite*. *Environ. Sci. Technol.*, 35: 3669–3675.
- Lundie, P. & McLeod, N. (1997): *Active containment systems incorporating modified pillared clays*. In: *Proc. Int. Containment Technol. Conf., Feb. 1997, St. Petersburg, Florida, USA: 718–724*.
- Ma, Q.Y., Traina, S.J., Logan, T.J. & Ryan, J.A. (1993): *In situ lead immobilization by apatite*. *Environ. Sci. Technol.*, 27: 1803–1810.
- Mackenzie, P.D., Horney, D.P. & Sivavec, T.M. (1999): *Mineral precipitation and porosity losses in granular iron columns*. *J. Haz. Mat.*, 68: 1–17.

- McMahon, P.B., Dennehy, K.F. & Sandstrom, M.W. (1999): *Hydraulic and geochemical performance of a permeable reactive barrier containing zero-valent iron, Denver Federal Center*. Ground Water, 37: 396–404.
- Meggyes, T. & Simon, F.-G. (2000): *Removal of organic and inorganic pollutants from groundwater using permeable reactive barriers – Part 2. Engineering of permeable reactive barriers*. Land Contamination & Reclamation, 8: 175–187.
- Morrison, S. (2003): *Performance Evaluation of a Permeable Reactive Barrier Using Reaction Products as Tracers*. Environ. Sci. Technol., 37: 2302–2309.
- Morrison, S.J. & Spangler, R.R. (1992): *Extraction of uranium and molybdenum from aqueous solution: A survey of industrial materials for use in chemical barriers for uranium mill tailings remediation*. Environ. Sci. Technol., 26: 1922–1931.
- Morrison, S.J., Spangler, R.R. & Tripathi, V.S. (1995a): *Adsorption of uranium(VI) on amorphous ferric oxyhydroxide at high concentrations of dissolved carbon(IV) and sulfur(VI)*. J. Cont. Hydrol., 17: 333–346.
- Morrison, S.J., Tripathi, V.S. & Spangler, R.R. (1995b): *Coupled reaction/transport modeling of a chemical barrier for controlling uranium(VI) contamination in groundwater*. J. Cont. Hydrol., 17: 347–363.
- Moyes, L.N., Parkman, R.H., Charnock, J.M., Vaughan, D.J., Livens, F.R., Hughes, C.R. & Braithwaite, A. (2000): *Uranium Uptake from Aqueous Solution by Interaction with Goethite, Lepidocrocite, Muscovite, and Mackinawite: An X-ray Absorption Spectroscopy Study*. Environ. Sci. Technol., 34: 1062–1068.
- O'Hannesin, S.F. & Gillham, R.W. (1998): *Long-term performance of an In Situ "Iron Wall" for remediation of VOCs*. Ground Water, 36: 164–170.
- Ouki, S.K., Cheesman, C. & Perry, R. (1993): *Effects of conditioning and treatment of chabazite and clinoptilolite prior to lead and cadmium removal*. Environ. Sci. Technol., 27: 1108–1116.
- Pansini, M. (1996): *Natural zeolites as cation exchangers for environmental protection*. Mineralium Deposita, 31: 563–575.
- Parbs, A., Ebert, M., Köber, R., Plagentz, V., Schad, H. & Dahmke, A. (2003): *Einsatz reaktiver Tracer zur Bewertung der Langzeitstabilität und Reaktivität von Fe(0)-Reaktionswänden*. Grundwasser, 3/2003: 146–156.
- Park, J.-B., Lee, S.-H., Lee, J.-W. & Lee, C.-Y. (2002): *Lab scale experiments for permeable reactive barriers against contaminated groundwater with ammonium and heavy metals using clinoptilolite (01-29B)*. J. Haz. Mat., B95: 65–79.
- Phifer, M.A., Nichols, R.L., Sappington, F.C., Steimke, J.L. & Jones, W.E. (2002): *GeoSiphon™ Ground Water Remediation System Hydraulics*. Report WSRC-MS-2002-00260, Westinghouse Savannah River Company, Aiken, South Carolina.
- Phillips, D.H., Gu, B., Watson, D.B., Roh, Y., Liang, L. & Lee, S.Y. (2000): *Performance Evaluation of a Zerovalent Iron Reactive Barrier: Mineralogical Characteristics*. Environ. Sci. Technol., 34: 4169–4176.
- Puls, R.W., Blowes, D.W. & Gillham, R.W. (1999): *Long-term performance monitoring for a permeable reactive barrier at the U.S. Coast Guard Support Center, Elisabeth City, North Carolina*. J. Haz. Mat., 68: 109–124.
- Rael, J., Shelton, S. & Dayaye, R. (1995): *Permeable Barriers to Remove Benzene: Candidate Media Evaluation*. J. Env. Eng., 121: 411–415.
- Roehl, K.E., Huttenloch, P. & Czurda, K. (2001): *Permeable Sorption Barriers for In-situ Remediation of Polluted Groundwater – Reactive Materials and Reaction Mechanisms*. In: Sarsby, R.W. & Meggyes, T. (eds.), *Proc. GREEN3 – The Exploitation of Natural Resources and the Consequences, June 2000, Berlin, 466–473*; Thomas Telford Publ., London.

- Schad, H. & Grathwohl, P. (1998): Funnel-and-gate systems for in situ treatment of contaminated groundwater at former manufactured gas plant sites. In: *NATO/CCMS Special Session on Treatment Walls and Permeable Reactive Barriers, 1998, Vienna, Austria*, EPA 542-R-98-003: 56–65.
- Schad, H., Haist-Gulde, B., Klein, R., Maier, D., Maier, M. & Schulze, B. (2001): Funnel-and Gate at the former manufactured gas plant site in Karlsruhe: Sorption test results, hydraulic and technical design, construction. In: *Proc. ConSoil 2000, 18–22 September 2000, Leipzig, Germany*: 951–959; Thomas Telford Publ., London.
- Scherer, M.M., Richter, S., Valentine, R.L. & Alvarez, P.J.J. (2000): *Chemistry and Microbiology of Permeable Reactive Barriers for In Situ Groundwater Clean up. Critical Reviews in Environ. Sci. Technol.*, 30: 363–411.
- Simon, F.-G. & Meggyes, T. (2000): *Removal of organic and inorganic pollutants from groundwater using permeable reactive barriers – Part 1. Treatment processes for pollutants*. Land Contamination & Reclamation, 8: 103–116.
- Sivavec, T., Krug, T., Berry-Spark, B. & Focht, R. (2003): *Performance Monitoring of a Permeable Reactive Barrier at the Somersworth, New Hampshire Landfill Superfund Site*. ACS Symposium Series, 837: 259–277.
- Smith, J.A. & Galan, A. (1995): *Sorption of non-ionic organic contaminants to single and dual organic cation bentonites from water*. Environ. Sci. Technol., 29: 685–692.
- Smith, J.A. & Jaffe, P.R. (1994): *Benzene transport through landfill liners containing organophilic bentonite*. J. Env. Eng., 120: 1559–1577.
- Sontheimer, H., Crittenden, J.C. & Summers, R.S. (1988): *Activated Carbon for Water Treatment*. DVGW-Forschungsstelle Karlsruhe, 2<sup>nd</sup> ed.: 722 p.
- Starr, R.C. & Cherry, J.A. (1994): *In Situ Remediation of Contaminated Ground Water: The Funnel-and-Gate System*. Ground Water, 32: 465–476.
- Tiehm, A., Schulze, S., Böckle, K., Müller, A., Lorbeer, H. & Werner, P. (2000): Elimination of chloroorganics in a reactive wall system by biodegradation on activated carbon. In: *Proc. ConSoil 2000, 18–22 September 2000, Leipzig, Germany*: 924–931; Thomas Telford Publ., London.
- Tratnyek, P.G., Scherer, M.M., Johnson, T.L. & Matheson, L.J. (2003): Permeable Reactive Barriers of Iron and Other Zero-Valent Metals. In: Tarr, M.A. (ed.), *Chemical degradation Methods for Wastes and Pollutants: Environmental and Industrial Applications*, Marcel Dekker, New York, 371–421.
- Vidic, R.D. & Pohland, F.G. (1996): *Treatment Walls*. GWRTAC, Pittsburgh, PA, Technology Evaluation Report, TE-96-01, 38 p.
- Vogan, J.L., Focht, R.M., Clark, D.K. & Graham, S.L. (1999): *Performance evaluation of a permeable reactive barrier for remediation of dissolved chlorinated solvents in groundwater*. J. Haz. Mat., 68: 97–108.
- Waybrant, K.R., Ptacek, C.J. & Blowes, D.W. (2002): *Treatment of Mine Drainage Using Permeable Reactive Barriers: Column Experiments*. Environ. Sci. Technol., 36: 1349–1356.
- Werner, P. (1998): The impact of microbial processes on the efficiency of reactive walls. In: Kovar, K. & Krasny, J. (eds.), *Groundwater Quality: Remediation and Protection. Proc. of the GQ'98 Conf. held at Tübingen, Germany, Sept. 1998*, IAHS Publ., 250: 497–500.
- Wolkersdorfer, Ch. & Younger, P.L. (2002): *Passive Grubenwasserreinigung als Alternative zu aktiven Systemen*. Grundwasser, 2/2002: 67–76.
- Xenidis, A., Moirou, A. & Paspaliaris, I. (2002): *Reactive Materials and Attenuation Processes for Permeable Reactive Barriers*. Mineral Wealth, 123: 35–49.
- Xu, Y. & Schwartz, F.W. (1994): *Lead immobilization by hydroxyapatite in aqueous solutions*. J. Cont. Hydrol., 15: 207–221.

- Yabusaki, S., Cantrell, K., Sass, B. & Steefel, C. (2001): *Multicomponent Reactive Transport in an In Situ Zero-Valent Iron Cell*. Environ. Sci. Technol., 35: 1493–1503.
- Younger, P.L. (2000): *The Adoption and Adaptation of Passive Treatment Technologies for Mine Waters in The United Kingdom*. Mine Water and the Environment, 19: 84–97.
- Zhu, L., Chen, B. & Shen, X. (2000): *Sorption of phenol, p-nitrophenol, and aniline to duality organobentonites from water*. Environ. Sci. Technol., 34: 468–475.

## Contact

Dr. Karl Ernst Roehl  
Geological Institute, Dept. Of Applied Geology, Karlsruhe University  
Kaiserstrasse 12, D-76128 Karlsruhe, Germany  
Phone: 49-721-6083096; Fax: 49-721-606279  
E-mail: [ke.roehl@agk.uni-karlsruhe.de](mailto:ke.roehl@agk.uni-karlsruhe.de)  
<http://www.agk.uni-karlsruhe.de/>

## **WETLAND TREATMENT OF MINE WATERS**

*P.L. Younger, Newcastle University, Department of Civil Engineering, UK*

*Keywords: Mine water, wetland, treatment, passive systems*

### **Introduction**

Mine water treatment wetlands are the most important category of a wider suite of treatment technologies which are termed “passive treatment”. A passive treatment system is defined by the European Commission's PIRAMID<sup>1</sup> project as follows:

“A water treatment system that utilises naturally available energy sources such as topographical gradient, microbial metabolic energy, photosynthesis and chemical energy and requires regular but infrequent maintenance to operate successfully over its design life”.

The working definition of “infrequent” in this context is currently around six-monthly.

Constructed wetland systems are currently the most widely-used passive mine water treatment technology, and are likely to remain so. There are several reasons for this, including:

1. The excellent track record of constructed, aerobic wetlands in treating net-alkaline mine waters in which the only pollutant of concern is iron. These systems are now so widespread, and invariably successful when designed and constructed in accordance with established guidelines (e.g. Hedin et al., 1994; Younger, 1997; 2000a), that they fully merit the tag of ‘proven technology’.
2. The generally low running costs of wetland systems in comparison to active treatment systems.
3. The inherent ability of large wetland systems to cope with unforeseen fluctuations in environmental conditions, by providing flexible storage volumes etc.
4. The environmental attractiveness of wetlands, as prime habitats for birds and other animals, and as landscape amenities of appeal to human visitors.

Notwithstanding these virtues, the use of wetlands for passive treatment of mine waters has not been without its detractors. Most of the mis-givings which have been expressed in the literature arise from cases where the technology has been misapplied and /or the data misinterpreted. For instance two instances may be cited from England alone in which disappointing early applications of wetlands technology gave rise to denigration of the technology as a whole. In both cases, the reason for the poor performance was that simple aerobic reed-beds were inappropriately constructed to receive extremely acidic spoil leachates, for which other technologies (compost wetlands or RAPS) are actually recommended. By contrast, 25 other UK systems were constructed around the same time in accordance with the guidelines of Hedin et al. (1994), all of which proved very successful (Younger, 2000a). These successes nullified the previous bad publicity, and both of the early, failed systems are now being retro-fitted with alkalinity-generating variants of wetland systems.

---

<sup>1</sup> For further details, see <http://www.piramid.org>, where thorough guidelines for passive system design can also be down-loaded free of charge.

Despite the numerous success stories, some wetlands-based technologies remain less certain in their applicability than others. In particular, wetlands treatment is still challenging for highly acidic waters, and may even be inadvisable for waters containing significant concentrations of xenobiotic metals (such as Hg and Cd). Hence we do not wish to give the impression that the techniques described below represent a panacea, and we will attempt to highlight current limitations to the technology as we see them.

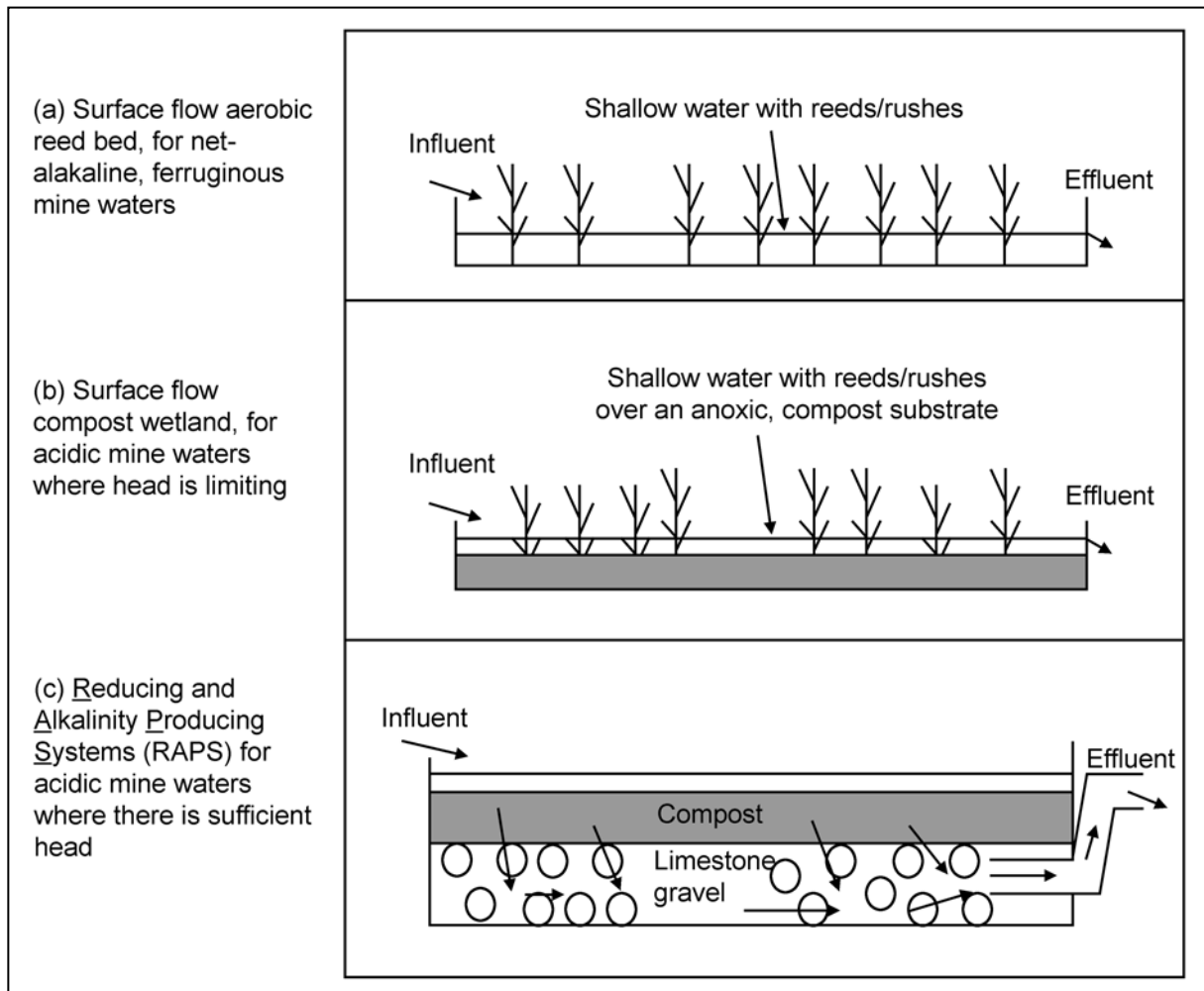

Fig. 1: Simple cross-sections illustrating the three types of wetland used to treat polluted mine waters (after Younger, 2000a).

### Mine water treatment wetlands in the UK

The development of passive treatment of mine waters in the UK up to September 1997 is documented in detail by Younger (1997; 2000a,b; 2001). There are currently about 30 constructed wetland systems treating mine waters in the UK. These systems are of three basic types (Figure 1):

- € Aerobic, surface flow wetlands (reed-beds) (Figure 1(a)).
- € Anaerobic, compost wetlands with significant surface flow (Figure 1(b)).
- € Mixed compost/limestone systems, with predominantly subsurface flow (Figure 1(c), which are also called RAPS (Reducing and Alkalinity Producing Systems (previously known also as Successive Alkalinity Producing Systems (SAPS); Kepler and McCleary, 1994).



The degree to which each type of system can currently be considered to be “proven technology” corresponds to the order in which they are listed above. This ranking of confidence is reflected in uptake rates (to 1–1–2002), with 15 full-scale reed-bed systems (of which 10 are operated by the Coal Authority, a national government agency), 5 RAPS and 4 compost wetlands.

### Variants of the technology and their applicability

Each of the three types of wetland treatment system shown on Figure 1 are appropriate for a different kind of mine water, or for specific hydraulic circumstances. These are as follows:

- i) Aerobic, surface flow wetlands (reed-beds) (Figure 1(a)): These are appropriate for removal of Fe (and to a lesser extent Mn) from net-alkaline mine waters<sup>2</sup>. The mine waters may be naturally net-alkaline (this is the case for many deep mine discharges), or else previously acidic waters which have since been neutralised by conventional alkali dosing, or by use of an anoxic limestone drain (no full-scale examples in the UK), or a RAPS. Simple aerobic reed-beds should not be applied to acidic waters – they will only lower the pH further!

Aerobic reed-beds are simply surface flow systems with shallow water (> 0.1 m depth < 0.5 m) densely planted with hardy wetland plants such as *Typha latifolia*, *Phragmites australis*, and *Juncus effusus*. Fe removal occurs by oxidation of Fe<sup>2+</sup> to Fe<sup>3+</sup>, which then hydrolyses to form ferric hydroxide (ochre). The plants baffle flows, oxygenate the substrate to prevent Fe<sup>3+</sup> from becoming reduced again, and (particularly at low Fe concentrations, as in 'polishing' applications, by direct plant uptake of metals (Batty, 1999).

- ii) Compost wetlands (Figure 1(b)): These are appropriate for the treatment of net-acidic mine waters<sup>3</sup> on sites where there is insufficient relief to provide the head to drive water through a RAPS unit (which would be the preferred technology for such waters where practicable). They consist of a surface flow wetland with very shallow water (typically < 0.15 m) over a thick (~ 0.5 m) substrate of compost which hosts anaerobic sulphate reducing bacteria (SRBs). The SRBs catalyse the reduction of SO<sub>4</sub><sup>2-</sup> to sulphide, which then reacts with the pollutant metals (except Al<sup>3+</sup>) to precipitate sulphide minerals which accumulate in the substrate. pH rises and HCO<sub>3</sub><sup>-</sup> alkalinity is generated as a by-product of the bacterial sulphate reduction, neutralising the acidity. Typical substrates used in UK systems to date include composts derived from horse manure, cow manure, municipal waste, tree bark mulch and spent mushroom compost. It is good practice to construct at least a small aerobic reed-bed downstream of a compost wetland, to remove residual Fe by aerobic processes and to re-oxygenate the water before it enters a receiving watercourse.
- iii) RAPS (Reducing and Alkalinity Producing Systems) (Figure 1(c)): These are the systems of choice for net-acidic mine waters, but they require a minimum relief of some 5 metres across the site if they are to be successfully constructed. This is because substantial losses of hydraulic head occur as water flows through the upper layer of compost (see Figure 1 (c)) into an underlying bed of limestone gravel. The addition of a limestone bed adds calcite dissolution as a major alkalinity-generating process, and the vertical subsurface flow through saturated compost ensures far more efficient sulphate reduction (and other anaerobic processes) than is achieved in compost wetlands. For this reason, a RAPS will

<sup>2</sup> Waters are 'net-alkaline' where their total alkalinity (which mainly reflects bicarbonate content in these waters) exceeds their total acidity (principally due to the content of hydroxide-forming metals, such as Fe, Mn, Al, Cu, Zn etc).

<sup>3</sup> In net-acidic mine waters, total acidity exceeds total alkalinity. The pH is not necessarily below 6.5 at the point of first emergence, but will typically drop below 4.5 if the water is aerated and left to stand.

typically have a much smaller 'footprint' than would a compost wetland treating the same water. (Younger et al., 2002, show that a RAPS will typically occupy only 15–20 % of the total area occupied by an equivalent compost wetland). As with compost wetlands, it is good practice to construct at least a small aerobic reed-bed downstream of a RAPS unit, to remove residual Fe by aerobic processes and to re-oxygenate the water before it enters a receiving watercourse.

## Design criteria

### Settling a controversy

Most wetlands operating in Europe (Younger, 2000a,b), and many of those constructed within the last 8 years in North America (Younger et al., 2002), have been successfully designed using guidance given by Hedin et al. (1994) of the former US Bureau of Mines. Recent unwarranted controversy has surrounded these design criteria, arising from a claim by Tarutis et al. (1999) that aerobic reed-beds should be designed assuming that oxidation of ferrous iron is the dominant treatment process. Since  $\text{Fe}^{2+}$  oxidation is known to be first-order in  $\text{Fe}^{2+}$  concentration, Tarutis et al. (1999) proposed a first-order kinetic model should be applied to mine water wetland design. This is a somewhat reductionist stance, given that (as Younger et al. (2002) have noted) the internal functioning of aerobic reed beds depends on precipitation and sedimentation kinetics in addition to oxidation alone. Furthermore, similar attempts to reduce the design of wastewater treatment wetlands to application of first-order BOD oxidation models have been trenchantly criticised by Kadlec (2000) on the grounds that they ignore variations in influent flow rates, variations in influent contaminant concentrations (which are rarely in phase with the flow variations), dispersion of flow and solute transport within the wetlands, and the likelihood that contaminant removal processes differ somewhat between the fast-flowing and stagnant zones within a treatment wetland. The net result of these factors is that the overall rate of contaminant removal in a treatment wetland is unlikely to be well-modelled by comparison only with the first order kinetics of one of the main chemical reaction processes. There is no *a priori* reason why the situation should be any better in the case of mine water treatment wetlands.

A simple example should suffice to demonstrate why the US Bureau of Mines criteria (Hedin et al., 1994) provide a more sensible basis for design than those proposed by Tarutis et al. (1999): The construction of the Coal Authority's Edmondsley wetland (County Durham, UK) was completed in the summer of 1999. The Edmondsley mine water flows from an old coal drift at a rate of about  $10 \text{ l.s}^{-1}$ , and contains some  $30 \text{ mg.l}^{-1}$  of Fe. The designers of the wetland used the Hedin et al. (1994) criteria to estimate the minimum wetland area required, obtaining a value of  $2505 \text{ m}^2$ . Fortunately, there was more than twice as much suitable land area available for purchase at the site. Hence, the system was constructed as four aerobic reed bed cells in series, totaling  $4000 \text{ m}^2$  in area. This design allowed one or two of the cells to be taken out of operation at any time for maintenance purposes without compromising the treatment ability of the system as a whole. Monitoring of the system since it was commissioned has shown performance in line with expectations, with virtually all of the Fe (down to a residual  $< 0.5 \text{ mg.l}^{-1}$ ) being removed in the first two cells (i.e. the first  $2000 \text{ m}^2$  of wetland). By contrast if the wetland had been designed using the first-order model proposed by Tarutis et al. (1999), the predicted area of wetland required would have nearly 2 ha! (Full details of the relevant calculations are given by Younger et al., 2002). Had the latter design figure been used, the costs of acquiring 2 ha of land in this scenic area would have precluded wetland treatment as a serious option. An active treatment system would have been developed, with huge cost implications for long-term operation.

### Recommended design criteria

Having thus satisfied ourselves that the US Bureau of Mines criteria (Hedin et al., 1994) remain the most valid design rules currently available, we can now summarise these as follows. The basic expression which must be evaluated is as follows:

$$A = \frac{Q_d (C_i - C_t)}{R_A}$$

Where  $A$  is the wetland area required ( $\text{m}^2$ ),  $Q_d$  is the design flow rate ( $\text{m}^3 \text{d}^{-1}$ ),  $C_i$  is the influent Fe concentration ( $\text{mg l}^{-1}$ ) and  $C_t$  the 'target effluent concentration' (i.e. the desired concentration of the pollutant at the downstream exist point of the wetland in  $\text{mg l}^{-1}$ ; a value of  $0.5 \text{ mg l}^{-1}$  is typically assumed for Fe), and  $R_A$  is an 'areally-adjusted removal rate' for the pollutant of interest ( $\text{g d}^{-1} \text{m}^{-2}$ ).

For Fe in aerobic reed beds,  $R_A$  is recommended to take a value of  $10 \text{ g d}^{-1} \text{m}^{-2}$ ; for Mn removal in such systems a much lower value of  $0.5 \text{ g d}^{-1} \text{m}^{-2}$  is recommended. For compost wetlands, usual practice is to define  $C_i$ ,  $C_t$  and  $R_A$  in terms of total acidity concentrations (in  $\text{mg l}^{-1}$  as  $\text{CaCO}_3$  equivalent), with an  $R_A$  value of  $3.5 \text{ g d}^{-1} \text{m}^{-2}$  total acidity being recommended. An analogous  $R_A$  value for total acidity removal in a RAPS with a minimum of 0.5 m of compost over 0.5 m of limestone gravel is estimated to lie around  $40 \text{ g d}^{-1} \text{m}^{-2}$  (Watzlaf et al., 2000). The PIRAMID Consortium (2003) provide a detailed compilation of alternative  $R_A$  values for other pollutants and various circumstances, as well as comprehensive guidance on the practicalities of wetland design for mine water treatment.

### Ancillary benefits of mine water treatment wetlands

One of the principal attractions of wetlands as treatment systems is the possibility of integrating them into the surrounding landscape (Campbell & Ogden, 2000), and achieving healthy connections with the existing eco-systems in the area. Integration of wetlands into a landscape at the level of aesthetics is readily attainable, as a number of recent projects illustrate (see following case studies). Ecological integration is rather harder to achieve in practice, however, due to a number of factors (Younger et al., 1998), including the following:

- ≠ physical limitations on the areas available for treatment
- ≠ the frequent insistence of regulators that treatment wetlands be surrounded by flood defence bunds, which preclude two way exchanges of water, solutes, sediments and plankton with adjoining rivers
- ≠ engineering limitations, such as the need to allow freeboard at the perimeters of systems and the need to prevent erosion by extreme flows.

### Case Study: The Quaking Houses community mine water treatment wetland

The Stanley Burn is a small headwater tributary of the River Wear, one of the principal rivers of north-east England. Since the mid-1980s, the Stanley Burn has suffered conspicuous pollution by acidic drainage emanating from a perched water table within a superficially restored waste rock pile appertaining to the former Morrison Busty Colliery (abandoned 1975). The

leachate contains up to 200 mg.l<sup>-1</sup> total acidity (as CaCO<sub>3</sub> equivalent), with elevated concentrations of Fe (Ω30 mg.l<sup>-1</sup>), Al (Ω30 mg.l<sup>-1</sup>) and Mn (Ω15 mg.l<sup>-1</sup>). This polluted drainage constitutes a classic 'orphan discharge' for which no legally responsible party could be identified. In 1994, when residents of the nearby village of Quaking Houses finally accepted that no remedial action was ever likely to be forthcoming from elsewhere, a "do-it-yourself" remedial programme was launched in collaboration with the mine water research team at Newcastle University. Drawing upon the inspiration of USA experiences (especially the work of the former US Bureau of Mines) passive treatment was soon identified as the most appropriate solution. As the water is acidic, a compost wetland system was the obvious choice, since these systems can generate alkalinity by means of bacterial sulphate reduction (sulphate being present at high concentrations in the mine drainage). However, given that compost wetland technology had no previous track record in Europe at that time, the first step in the remedial program was to build and monitor a small-scale pilot wetland (Younger et al., 1997). This not only allowed the designers to gain valuable hands-on experience which would prove invaluable later, but also proved crucial in building confidence in the efficacy of the technology amongst regulators and potential sponsors. In essence, the pilot system was a shallow pond, 45m<sup>2</sup> in area, with a 0.3 m substrate of horse manure and straw from the Quaking Houses Village Stables. It was designed to treat around 5 % of the average leachate flow. After 18 months of monitoring, this pilot wetland yielded an average removal rate of 9 g.d<sup>-1</sup>.m<sup>-2</sup> total acidity (as CaCO<sub>3</sub> equivalent), which compared favourably with the comparable rates derived from studies of similar systems in the USA (i.e. 3.5 to 7 g.d<sup>-1</sup>.m<sup>-2</sup>; USBM data).

These encouraging performance figures, and the pleasant appearance of the pilot wetland, proved influential with potential sponsors, and by mid-1997 sufficient funding had been obtained from a range of charitable and philanthropic foundations to finance the construction of a full-scale system. While the pilot plant had been in operation, the seminal work of Kepler and McCleary (1994) had begun to influence passive system design in the UK, and preliminary plans were laid to construct the full-scale system at Quaking Houses as a RAPS (a vertical-flow system in which water flows in the subsurface, first through compost then through limestone). However, when the available plot of land was finally cleared of scrub vegetation and trial-pitted, it was found to be underlain by highly pyritic waste materials derived from a previously unrecorded coal washery finings pond. This meant that excavation of a suitable basin to install a RAPS would have entailed disposal of large volumes of highly reactive, acid-generating waste, the landfilling of which would have consumed much of the budget available for wetland construction. Without such excavation, there was a maximum of 1.0 m of head available across the entire site, which is insufficient to drive water through a RAPS; hence the full-scale system was designed as a compost wetland, scaled-up from the original pilot-plant design.

Construction of the wetland commenced in August 1997 and took about 6 weeks of site work (Jarvis & Younger, 1999). The leachate was captured by construction of a concrete headwall across the outfall of the culvert from which the discharge emanates. This headwall gained some 0.5 m of head to help drive water through the system. Two sections of 100 mm diameter pipe were built into the headwall. The first carries water underground in an inverted siphon to the influent point of the wetland, discharging into a basin from where the water is distributed across the width of the wetland. The second section of pipe allows overflow back into the original watercourse when flow-rates exceed approximately 400 litres per minute. Because pollutant concentrations are lower at higher flow-rates due to dilution, and because of further dilution of the overflow water by the effluent from the wetland, the impact of this water on the receiving watercourse is minimal.

The heart of the Quaking Houses treatment system is a compost wetland unit occupying some 440 m<sup>2</sup> (Figure 2). This is enclosed by a bund composed of pulverised fuel ash (PFA), which is both strong and highly impermeable after mechanical compaction, yet costs less than half the price of the main alternative material (clay). To avoid toe drainage, which may have affected the integrity of the bund, the base of the embankment was sunk approximately 0.2m into the *in situ* soil. The bund had a minimum crest width of 1.5 m, with inner slope angles (i.e. facing into the ponded area) of 1:3 or less, in order to encourage wildlife. (Outer slope angles were made to be not more than 1:2). Baffles and islands were also constructed from PFA, both to help minimise hydraulic short-circuiting within each wetland cell and to improve the appearance and habitat diversity of the wetland. PFA was also used to construct a central weir of about 0.4 m height, which was incorporated into the design for four reasons:

- € To accommodate the natural slope of the site away from the influent point: if the bund crest had been maintained at the same elevation around the entire wetland, much more PFA would have been needed, construction would have taken longer, and less area would have been available for treatment unless the slopes were steepened significantly
- € To minimise short-circuiting by re-spreading the water at the entrance to the second basin.
- € To allow one or other of the basins to be taken out of commission for maintenance at any one time without totally losing treatment capacity.
- € To provide an attractive waterfall feature in the middle of the wetland.

Because the horse manure used in the pilot-scale wetland was not available in sufficient quantity, additional sources of compost were sought: the final compost wetland substrate comprises horse manure, cattle manure and municipal waste compost in the following proportions: 30:40:30. Additionally 30 tonnes of limestone were deposited at the far end of the wetland, to facilitate final pH adjustment if it should be required. The system was designed such that the compost depth in the wetland would be 0.3–0.5 m, leaving 0.30 m of freeboard for future accumulation of material on the substrate surface.

When first constructed, the water leaving the compost wetland was routed directly to the Stanley Burn. Subsequently, an aerobic wetland unit was added to the end of the system, to polish residual iron concentrations down to below 0.5 mg.l<sup>-1</sup>. This comprises a circular, ornamental 'willow pond' and an appropriated area of natural *Juncus* stands, totalling some 100 m<sup>2</sup> in area. It should be noted that, for illustrative purposes, the contaminant removal rates and efficiencies discussed below relate only to the compost wetland unit (ponds 1 and 2), not to the passive treatment system as a whole, which achieves significantly more Fe removal than the compost wetland alone.

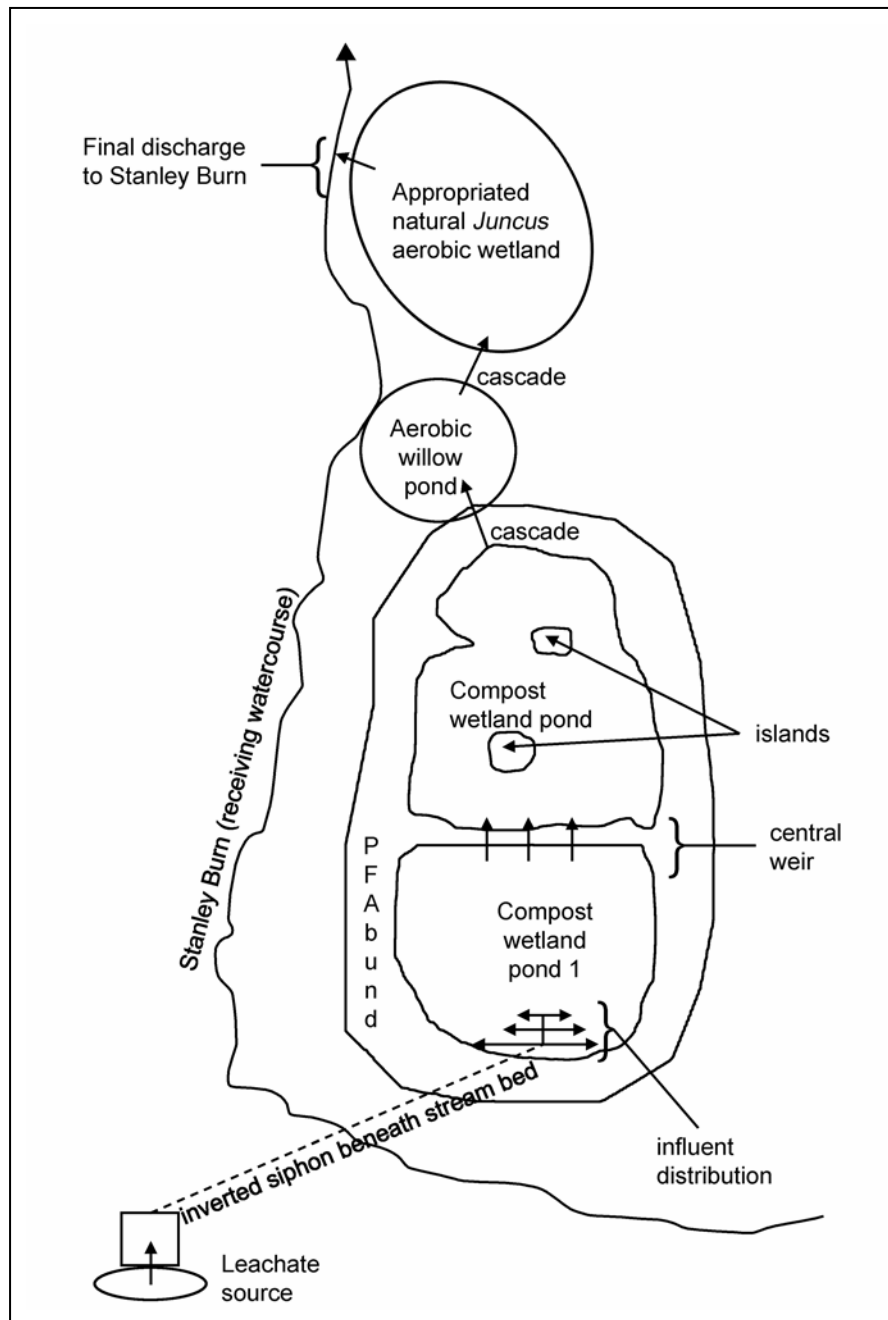

Fig. 2: Layout of the Quaking Houses mine water treatment wetland (after Younger et al., 2002)

Monitoring of the compost wetland unit within the Quaking Houses system over its first 27 months of operation (Jarvis, 2000) revealed a mean acidity removal rate of  $5.6 \text{ g.d}^{-1}.\text{m}^{-2}$ . This mean value falls almost exactly in the middle of the range of values ( $3.5\text{--}7 \text{ g.d}^{-1}.\text{m}^{-2}$ ) derived from studying similar systems in the USA. However, acidity removal performance ranges from  $1.3\text{--}46.1 \text{ g.d}^{-1}.\text{m}^{-2}$ , with the higher rates corresponding to times when the influent was at its most acidic. This is consistent with other evidence which suggests that the overall acidity removal reaction may be first order in acidity.

One major benefit of the Quaking Houses passive treatment project deserves further mention here: once the long-term pollution from acidic mine site drainage had been abated, pressures mounted for the clean-up of other sources of pollution to the stream (particularly from com-

bined sewer overflows and deicing salt store runoff). Previously, the organisations responsible for these two sources of pollution had justifiably claimed that there was little point treating their effluents to higher standards given that the acid drainage was clearly killing all aquatic life in its path. With that excuse removed, the other sources of pollution soon became priorities for clean-up, with the result that the Stanley Burn has now been thoroughly restored as a healthy stream ecosystem.

## Acknowledgements

The concepts presented above are by no means all my own work; they have evolved through collaboration with a wide range of colleagues, most notably Dr Adam Jarvis (now at IMC Ltd), Dr Bob Hedin (Hedin Environmental Inc., Pittsburgh, USA), Mr David Laine (IMC Ltd), Dr Lesley Batty (Newcastle University) and the volunteers of the Quaking Houses Environmental Trust, who maintain the Quaking Houses wetland to this day.

## References

- Batty, L.C. (1999): *Metal removal processes in wetlands receiving acid mine drainage*. PhD Thesis, Department of Animal and Plant Sciences, University of Sheffield, UK. 254pp.
- Campbell, C.S. & Ogden, M.H. (1999): *Constructed wetlands in the sustainable landscape*. Wiley, New York. 270pp.
- Hedin, R.S., Nairn, R.W. & Kleinmann, R.L.P. (1994): *Passive treatment of polluted coal mine drainage*. Bureau of Mines Information Circular 9389. United States Department of Interior, Washington DC. 35pp.
- Jarvis, A.P., (2000): *Design, construction and performance of passive systems for the treatment of mine and spoil heap drainage*. Unpublished PhD Thesis, Department of Civil Engineering, University of Newcastle, UK. 231pp.
- Jarvis, A.P. & Younger, P.L. (1999): Design, construction and performance of a full-scale wetland for mine spoil drainage treatment, Quaking Houses, UK. *Journal of the Chartered Institution of Water and Environmental Management*, 13, pp 313–318.
- Kadlec, R.H. (2000): *The inadequacy of first-order treatment wetland models*. *Ecological Engineering*, 15, pp 105–119.
- Kepler, D.A. & McCleary, E.C. (1994): Successive Alkalinity Producing Systems (SAPS) for the Treatment of Acidic Mine Drainage. *Proceedings of the International Land Reclamation and Mine Drainage Conference and the 3rd International Conference on the Abatement of Acidic Drainage*. (Pittsburgh, PA; April 1994). Volume 1: Mine Drainage. pp 195–204.
- PIRAMID Consortium (2003): *Engineering guidelines for the passive remediation of acidic and/or metalliferous mine drainage and similar wastewaters*. European Commission 5<sup>th</sup> Framework RTD Project no. EVK1-CT-1999-000021 "Passive *in-situ* remediation of acidic mine/industrial drainage" (PIRAMID). University of Newcastle Upon Tyne, Newcastle Upon Tyne UK. 164pp.
- Tarutis W.J., Stark L.R. & Williams F.M. (1999): Sizing and performance estimation of coal mine drainage wetlands. *Ecological Engineering*, 12, pp 353–372.
- Watzlaf, G.R., Schroeder, K.T. & Kairies, C. (2000): Long-term performance of alkalinity-producing passive systems for the treatment of mine drainage. *Proceedings of the 2000 National Meeting of the American Society for Surface Mining and Reclamation*, Tampa, Florida, June 11–15, 2000.

- Younger, P.L. (Editor), (1997): Minewater Treatment Using Wetlands. Proceedings of a National Conference held 5th September 1997, at the University of Newcastle, UK. Chartered Institution of Water and Environmental Management, London. 189pp.
- Younger, P.L. (2000a): Holistic remedial strategies for short- and long-term water pollution from abandoned mines. *Transactions of the Institution of Mining and Metallurgy*\_(Section A), **109**, A210–A218.
- Younger, P.L. (2000b): The adoption and adaptation of passive treatment technologies for mine waters in the United Kingdom. *Mine Water and the Environment*, **19**, pp 84–97
- Younger, P.L. (2001): Mine water pollution in Scotland: nature, extent and preventative strategies. *Science of the Total Environment*, **265**, pp 309–326.
- Younger, P.L., Banwart, S.A. & Hedin, R.S. (2002): *Mine Water: Hydrology, Pollution, Remediation*. Kluwer, Amsterdam.
- Younger, P.L., Curtis, T.P., Jarvis, A.P. & Pennell, R. (1997): Effective passive treatment of aluminium-rich, acidic colliery spoil drainage using a compost wetland at Quaking Houses, County Durham. *Journal of the Chartered Institution of Water and Environmental Management*, **11**, 200–208.
- Younger, P.L., Large, A.R.G. & Jarvis, A.P. (1998): The creation of floodplain wetlands to passively treat polluted minewaters. In Wheater, H. & Kirby, C. (eds.), *Hydrology in a Changing Environment*. Volume I. pp 495–515.

## Contact

Paul L. Younger  
School of Civil Engineering and Geosciences  
University of Newcastle  
Drummond Building  
UK - NE1 7RU Newcastle upon Tyne  
Phone: + 44 191 222 7942, Fax.: + 44 191 222 6669  
E-mail: p.l.younger@ncl.ac.uk



## **CASE STUDY: REMEDIATION OF A FORMER URANIUM MINING/PROCESSING SITE IN HUNGARY**

*M. Csövári, Zs. Berta, J. Csicsák, J. Hideg, A. Varhegyi, Mecsekérc Rt, Hungary ralia*

*Keywords: Groundwater remediation, metal removal, mine water treatment, reactive barrier, remediation, tailings, uranium removal*

### **Abstract**

The Hungarian uranium mining activities near Pécs lasted from 1958 to 1997. Approximately 46 Mt of rock were mined, from which 18.8 Mt of upgraded ore were processed. Some ore had been exported prior to the construction of the processing plant at the site. Remediation of the former uranium-related industrial sites is being carried out by the Mecsek Ore Environment Ltd. and started in the 1990's. Today the former mines and their surroundings are rehabilitated, former heap piles and a number of smaller waste rock piles have been relocated to a more protected area (waste rock pile N 3). Ongoing core remediation activities are directed to the remediation of the tailings ponds, and also water treatment issues are most important. Three water treatment facilities are currently in operation:

- € A mine water treatment system with the objective to remove uranium and gain a marketable by-product.
- € A pump-and-treat system to restore the groundwater quality in the vicinity of the tailing ponds.
- € A pilot-scale, experimental passive in-situ groundwater treatment system to avoid migration of uranium contaminated groundwater.

### **General overview of the world uranium production**

World uranium production is summarised in Tab. 1 based on data collected by the OECD and IAEA (OECD-IAEA, 2002). It can be seen that up to the year 2000 approximately 1.9 Mt of uranium were produced in 34 countries. The Hungarian production rate was on the level of 500–600 t/a. At beginning of the new millennium production rates decreased dramatically, and in 2001 only 12 countries operated an industrial-scale uranium production with a total production of approximately 37 kt of uranium. Main producing countries are currently Canada (11 kt/a), Australia (8 kt/a), Niger, Namibia, Russian Federation, Kazakhstan, Uzbekistan (each ~ 3 kt/a). Today in Europe uranium is produced in small quantities only in the Ukraine, Romania and the Czech Republic. Some minor quantities are obtained as by-product from remediation activities (e.g. in Germany, Hungary).

The historical development of the market price for uranium is shown in Fig.1. Since 1980 the price dropped continuously from approximately 150 US\$/kg to the current value of 20–30 US\$/kg (Pool, 2002). The boom at the end of seventies is attributed to the world energy crises. Most uranium producing countries could not adjust their production costs to the level of the post-cold-war market price and thus terminated their production. This was also the case in Hungary.

Tab. 1: Uranium production in the world (OECD-IAEA, 2002).

Country	Uranium production total to 2000 [t]	Expected production for 2001 [t]
Argentina	2,509	0
Brazil	1,110	250
USA	353,796	1,077
Canada	340,523	11,250
Namibia	72,127	2,702
South-Africa	153,337	1,160
Gabon	27,872	0
Niger	81,853	2,910
Australia	91,157	7,700
Germany	5,462	20
GDR	213,380	0
Czech Republic <sup>(1)</sup>	107,080	501
France	73,664	120
Bulgaria	16,720	0
Hungary	21,030	10
Romania*	17,729	85
Estonia		0
Sweden	215	0
Spain	4,961	30
Portugal	3,717	3
Belgium	686	0
Finland	30	0
Yugoslavia	380	0
Poland	660	0
Ukraine (since 1992)*	10,000	1,000
Russian Fed.*	114,223	2,910
Uzbekistan	95,758	2,350
Kazakhstan	88,372	2,250
India*	7,273	207
Pakistan*	837	23
China*	7,435	700
Japan		
<b>Total</b>	<b>1,913,896</b>	<b>37,258</b>

<sup>(1)</sup> Czech Republic: Aggregated production of the mines MAPE, Hamr, Rozna, Příbram, Neidek, and Eliás (Jachimovo).

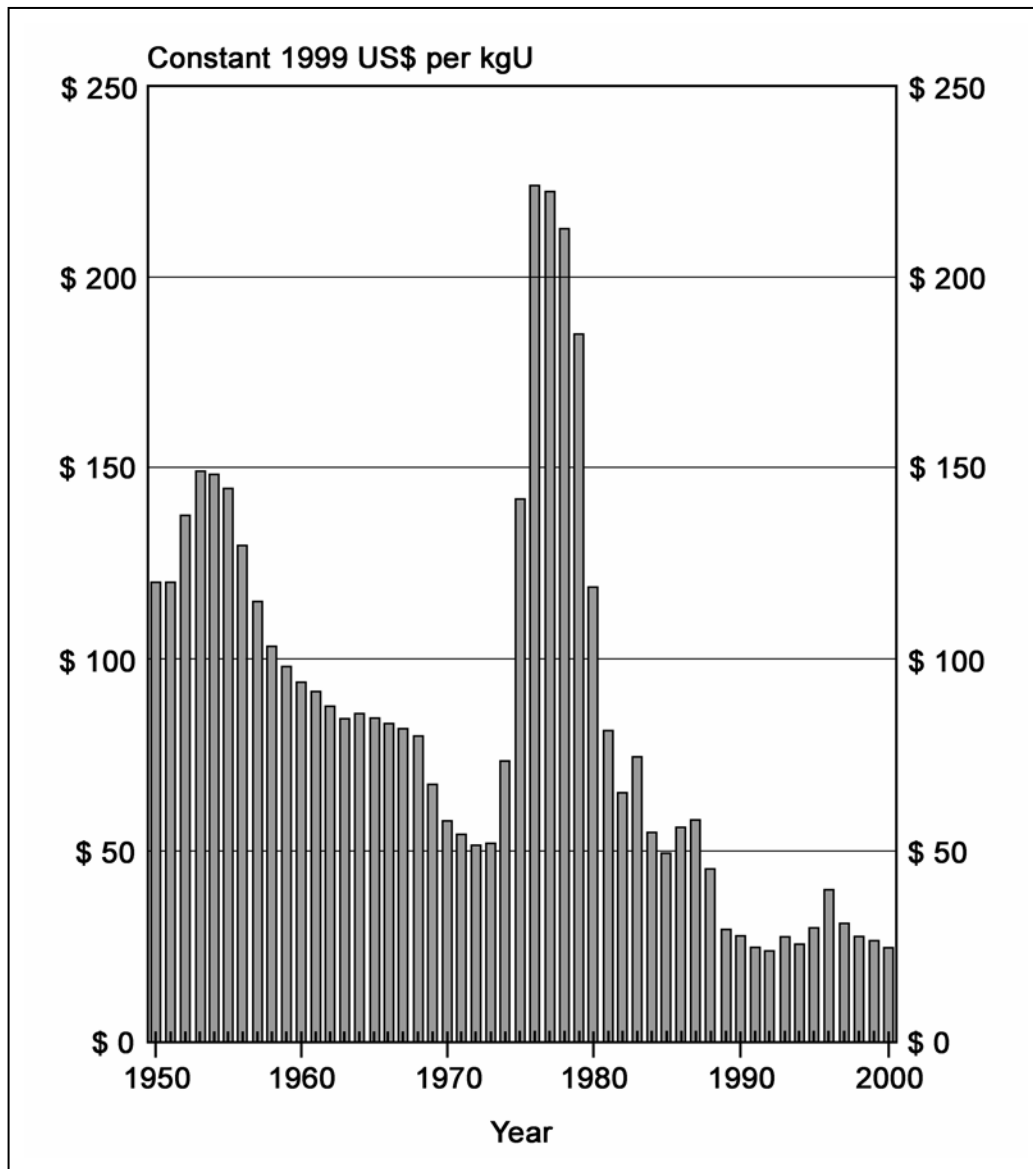

Fig. 1: Historical price for uranium (source: Pool, 2002).

## Project structure

The remediation of the former uranium mining and processing area started with defining priority areas and remediation targets. Subprojects were defined and an appropriate time schedule was set up (Tab. 2). The overall remediation plan was split into 10 sub-projects. Most of these sub-projects are today completed. The subprojects “water treatment”, “remediation of tailing ponds” and “monitoring” are still in progress. The remediation of the tailings ponds will take more time than initially anticipated. The expected remediation endpoint is currently defined with the year 2005.

Tab. 2: The main sub-projects of the remediation program.

N <sup>o</sup>	Subproject title	Year						
		1998	1999	2000	2001	2002	2003	2004
1	Underground mines							
2	Surficial facilities and areas							
3	Waste rock piles and their environment							
4	Heap-leaching sites							
5	Tailings ponds							
6	Mine water treatment							
7	Reconstruction of electric network							
8	Reconstruction of water and sewage system							
9	Other infrastructural service							
10	Monitoring and miscellaneous activity							
	Total							

The total sum estimated for the remediation projects amounts to approximately 18 billion HUF (~ 85 million US\$). These expenditures are covered by the Hungarian state budget.

The following chapters provide a short review of those sub-projects directly connected to the surface and groundwater protection.

### Processing practice used by Mecsekérc

Dissolution or leaching of the uranium minerals is the most important step in the processing of uranium ores. A major part of the reagents needed for the process is consumed at this stage due to the dissolution of gangue minerals.

### Leaching chemistry

Uranium in minerals exists in tetravalent or hexavalent form. In its hexavalent form uranium goes directly into solution according to the equation (1):



H<sup>+</sup> is supplied either by acids, or by bicarbonate in alkaline carbonate processes.

When uranium is present in tetravalent form, e.g. in form of uraninite (UO<sub>2</sub>) it does not dissolve at an acceptable rate and requires oxidising into hexavalent form:



The oxidising reaction is a rather complex process. In acidic condition rapid oxidation can be achieved by the presence of ferric ion in the process solution:



To maintain the dissolution of  $\text{UO}_2$  the  $\text{Fe}^{2+}$  must be oxidised to  $\text{Fe}^{3+}$ , e.g. by manganese dioxide. This process requires hydrogen ions, too:

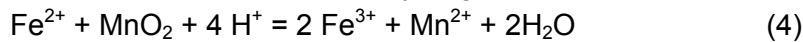

Instead of manganese dioxide sodium, chlorate or Caro's acid ( $\text{H}_2\text{SO}_5$ ) can be applied.

The Mecsekérc Company used two kinds of chemical ore treatment practices (Fig. 2):

- € acid leaching for radiometrically upgraded ore
- € alkaline heap leaching for low-grade ore

Approximately 97 % of the total uranium production (18.1 kt) were obtained in an acid leaching mill process and only 3 % by heap leaching.

The volumes of waste generated in the processes were:

- € 7.2 Mt of solid residues and 0.2 Mm<sup>3</sup> of liquid wastes from heap leaching
- € 20.3 Mt of solid residues and 32 Mm<sup>3</sup> of liquid wastes from the acid leaching mill process

Alkaline heap leaching was carried out constructing heaps like that shown in Fig. 3. Low-grade ore and partially rejects from a radiometric sorting stage (approximately 33 % of the rock mass were separated from the run-off ore as gangue minerals) were crushed to a size of < 30 mm and dumped to the pad constructed for this purpose. The bottom of the pad was sealed with two layers of plastic foils.

Sodium carbonate and bicarbonate solution (leaching agents) were percolated through the heaps to leach the uranium. The collected leachate was pumped to ion exchange columns, where the uranium was sorbed by an anion exchange resin (Varion AP). The barren solution was circulated back on the top of the piles. The resin loaded with uranium was regenerated and the eluate (U concentration ~ 10 g/l) was then processed to yellow cake. Using this technology approximately 7.2 Mt of low-grade ore was processed, removing 545 t uranium from the ore.

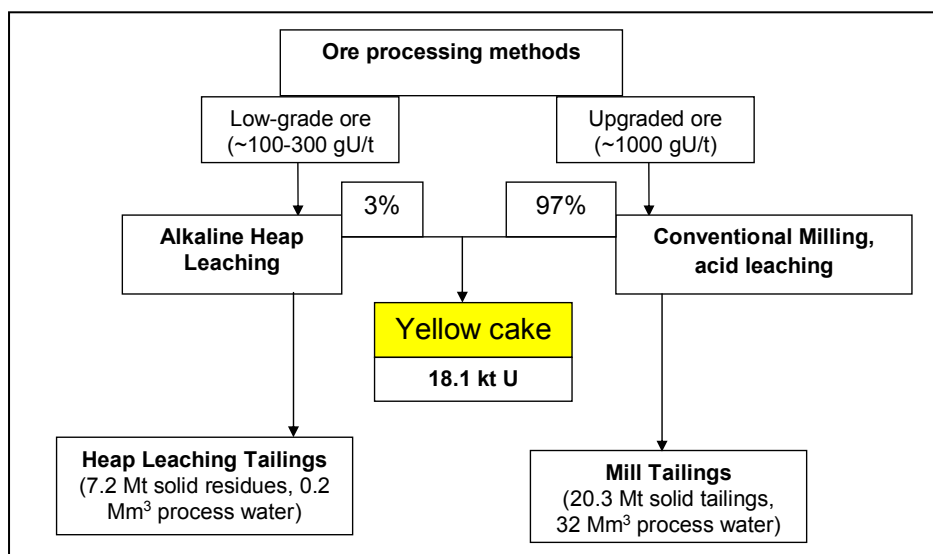

Fig. 2: Processing methods and the volume of generated tailings at the Mecsekérc installations.

Acid leaching is usually carried out with sulphuric acid in a co-current or counter-current set-up. At the Mecsekérc installations the co-current technology was used. In the leaching system at least two acid concentration steps were maintained with high concentrations (100 g/l or more) at the head and low concentrations (5–10 g/l) at the end of the leaching. Uranium was removed from pulp (density 1.18 kg/l) using an anion exchange resin. The loaded resin was re-generated with solution containing hydrochloric acid and sodium chloride. Uranium was precipitated from the eluate with lime milk. Thus the end-product (yellow cake) was calcium diuranate. One of the two heap leaching areas is shown in Fig. 3.



Fig. 3: Alkaline heap leaching at the former uranium mining and processing site near Pécs.

## Remediation

Remediation work is carried out in accordance with the environmental license issued by the local authorities. In the following chapter some important steps of the performed remediation work is presented. Special attention is given to water protection issues. According to the license the limits for discharges are as follows:

Natural uranium in water:	2 mg/l
Radium-226:	1.1 Bq/l

Individual discharge limits are given for discharge of all collected waters:

Total dissolved solids:	5000 mg/l
Specific conductivity in the receiver (at village Zók):	2000 $\mu$ S/cm

## Remediation of heap leaching sites

Total area of the heap leaching sites was approximately 47 ha. It was decided to relocate all solid residues to waste rock pile N3, which was thought to be more suitable for long-term repository of wastes. The heaps were washed with mine water for two years prior to the relocation. The collected solution from the heaps was treated, and uranium and radium were removed.

The solid residues were relocated to waste rock pile N3, on which a lime-based reactive barrier was built for retardation of uranium in seepage. The heap residues were placed on lime-containing layers (1.5 kg CaO per t of residues), which proved to be very effective in the retardation of uranium. A detailed description of the reactive barrier is given by Csövári et al. (2002).

## Mine water treatment

The geological cross-section of the former mining area is shown in Fig. 4. It can be seen that the mining area is principally divided into two parts: the southern part is closely connected with the drinking water aquifer situated at foot of Mecsek hills, the northern part has no direct connection with that area. During the period of active mining, mine water from both areas has been partly used for milling and other industrial purposes. Water chemistry for the mine waters and seepage from waste rocks is presented in Tab. 3.

Both the mine water and the seepage show an elevated uranium concentration. This means that though the pyrite content of the rock is low (much less than 1 %), some geo-chemical processes take place and uranium has been dissolved. At the same time dolomite and perhaps other gangue minerals are also dissolving. The heavy metal content is low ( $\ll 1$  mg/l), and arsenic concentration is approximately 10  $\mu$ g/l (data not given in the table). It is worth to mention that uranium is still high (above the discharge limit) in the seepage. Therefore the water has to be treated for removing of uranium. Other constituents are acceptable and do not require additional treatment.

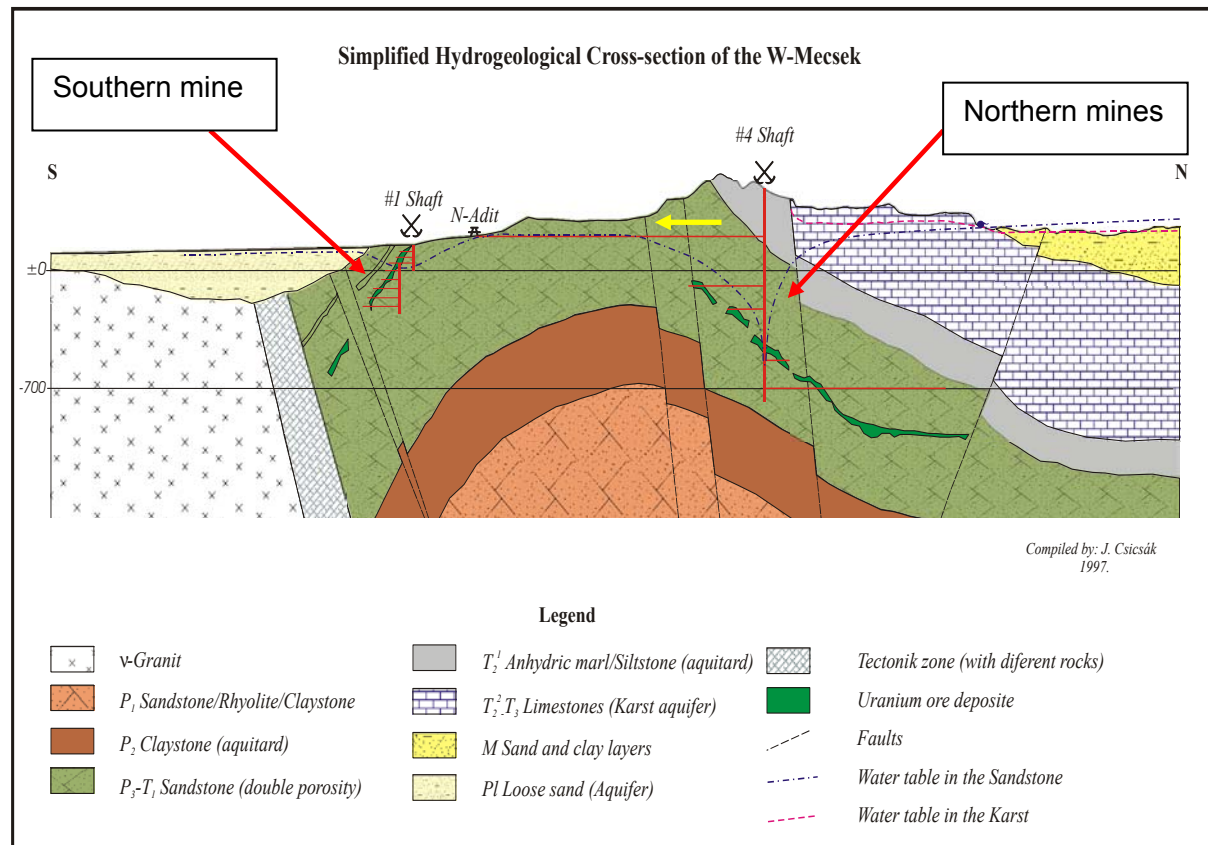

Fig. 4.: Geological cross-section of the mining area.

Uranium mining had started in the Southern part, in mine N1. After closing this mine in 1968 authorities demanded that a depression funnel is kept around the mine (to keep the water level in the mine at 106 m below surface) to protect the drinking water aquifer from the uranium-contaminated mine water. The depression funnel was maintained by pumping. The extracted water had to be treated prior to discharge.





The obtained solution contains approximately 10 g/l of dissolved uranium.

#### Precipitation of uranium:

Uranium can be precipitated from solution obtained in the sorption-desorption process in alkaline medium by ammonia, magnesium oxide, sodium hydroxide, etc. or from acidic medium (pH ~ 3–4) by hydrogen peroxide solution.

At Mecsekérc, hydrogen peroxide is used since it is more acceptable from environmental point of view and provides a yellow cake of high purity. In a first step the carbonate complexes are decomposed by hydrochloric acid:

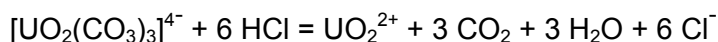

In the second step the uranium is precipitated in form of uranium peroxide:

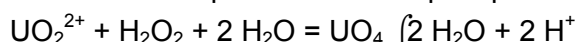

Fig. 5: Facility for yellow cake by-production.

The treated water is led to the discharge point (nearby the tailings ponds), where it is mixed with treated groundwater. The mixed water is discharged into the receiver.

Earlier, the loaded anion exchange resin was further processed in the mill. After termination of the uranium mining activities and decommissioning of the mill a new small yellow cake production facility has been built in which a commercial-grade yellow cake is produced as a by-product of the water treatment efforts. The facilities for thickening and packing of uranium peroxide in the new plant is shown in Fig. 5.

Also the seepage from waste rock piles contains elevated uranium; therefore these waters are treated together with the mine water.

At present it is not known how long the mine water treatment process will have to last. Up to now altogether more than 130 t of uranium have been removed from mine water (1968–2002). The current uranium concentration in the mine water is still high, approximately 3–5 mg/l, while it reached 7–8 mg/l in the past.

#### Remediation of tailings ponds and their surroundings

The main part of the uranium ore was processed by the conventional milling process. The generated tailings were deposited in ponds constructed without or with very poor sealing. Therefore process water from the tailings ponds partly seeped into the underlying subsoil.

TDS was in average approximately 22 g/l in the process water. It has been estimated that approximately 23 Mm<sup>3</sup> of process water seeped into the surrounding soils, causing a huge chemical contamination of groundwater. The average concentration of different constituents of the process water is presented in Tab. 4.

Main polluting components are magnesium sulphate (originated from dolomite in the processed ore) and sodium chloride (originated from the ion exchange process). Nitrate is originated from the explosives used in the mines.

Therefore, tailings ponds remediation is connected with solving two main problems:

- € groundwater quality restoration,
- € long-term stabilisation of tailings ponds.

A general overview of the tasks to be solved at the tailings ponds is given in Fig. 6.

Tab. 4: Water chemistry of the seepage on tailings ponds.

Na	K	Ca	Mg	Mn	SO <sub>4</sub>	Cl	NO <sub>3</sub>	TDS	U	Ra
				mg/l					mg/l	Bq/l
1.1	0.18	0.6	2.8	0.8	12.8	2.4	0.2	~22	~0.05	~5

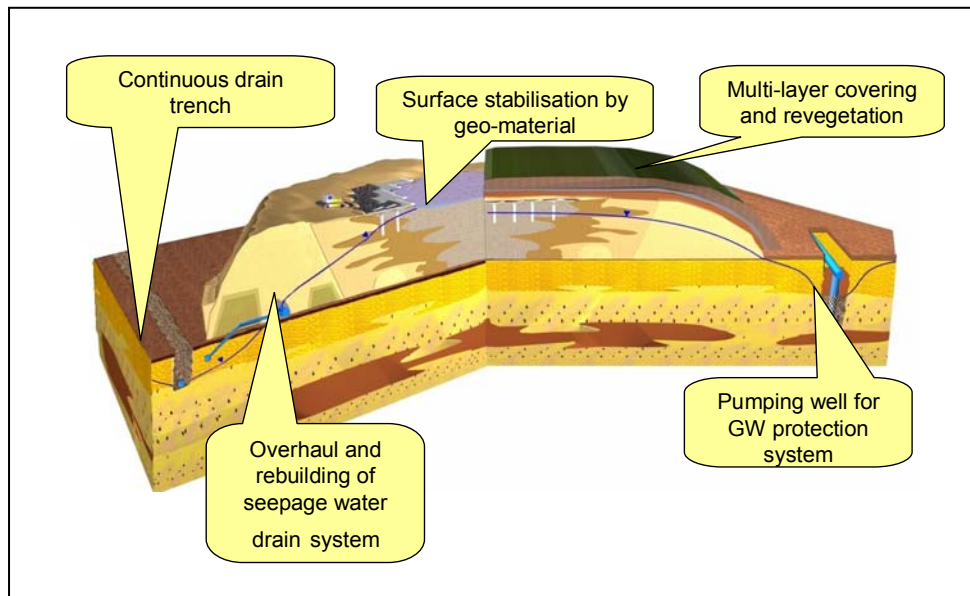

Fig. 6: General overview of tasks at the tailings ponds.

Groundwater restoration consists of extracting the contaminated water by deep drainage and wells. Long-term stabilisation of tailings ponds can be carried out by dewatering of the inner slime core, covering the reshaped surface with a low permeable multi-layer cover system and finally with re-vegetating the newly formed surface of the tailings.

Because of a lack of sealing layers and inadequate neutralisation of the barren pulp at the end of the mill process (neutralisation was carried out to pH ~ 7–7.5), app. 400 kt of chemical compounds seeped into the groundwater with process water causing a huge contamination around the tailings ponds. The seepage of highly contaminated process water caused a huge groundwater contamination in the surrounding of the tailings ponds. This contamination can be seen in Fig. 7, where the distribution of TDS in groundwater is presented.

### Groundwater restoration

Hydrological modelling showed that the contaminated groundwater could reach the drinking water wells built near the tailings ponds (some of them in a distance of only 1 km). Therefore measures had to be taken for the protection of the drinking water quality. After evaluating different options a pump-and-treat system was adopted for groundwater restoration. The system was implemented in 2000.

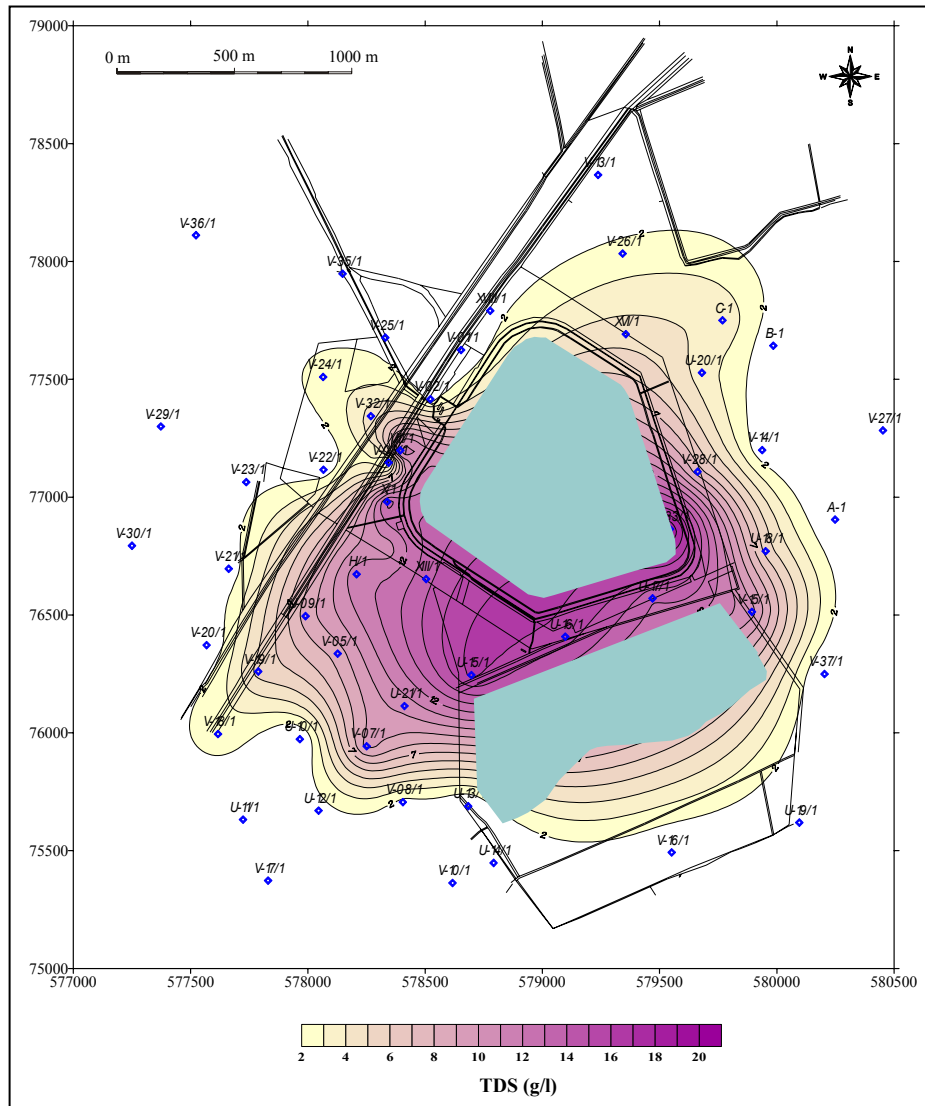

Fig. 7: Contamination of the shallow groundwater around the tailings ponds.

### Groundwater extraction

The monitoring data showed that the shallow groundwater aquifer (0–10 m) was most heavily polluted and was therefore the priority target of the remediation measures. Based on modelling data and worldwide experience a drainage system was constructed and extraction wells were built.

Total length of the drainage (which is placed in approximately 9 m depth) is 2.9 km. 7 extraction wells for shallow groundwater and 7 for contaminated deeper water are at present in operation, too. It is supposed that after evaluation of the operation of the existing extraction system additional drainage and wells will be built for the still escaping contaminated water. The

locations of the drainage and wells are presented in Fig. 8. The system is capable of extracting approximately 1500 m<sup>3</sup> of contaminated water per day.

### Treatment of the extracted water

Composition of extracted water in individual wells depends on the location of the wells and drainage. In average the TDS is 13 g/l in the collected water. It contains mainly magnesium in form of magnesium sulphate (5–6 g/l), and sodium chloride (2–3 g/l). Such water has to be treated prior to discharge it into the local receiver. Uranium concentration in groundwater is generally low, with some exceptions less than 30 µg/l. This low uranium concentration is most likely due to the sorption processes taking place in the soil. Therefore only the salinity of the water is regarded as polluting component, which has to be decreased prior to the discharge of the water into the receiver.

Effective desalination of such water can be achieved by reverse osmosis, as it was demonstrated in our laboratories. But this method is not reasonable from economic point of view. Instead, a commonly used lime process had been chosen for the removal of magnesium sulphate:

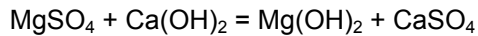

Of course uranium present in the water also precipitates in this process, though its concentration is much below the discharge limit even in the original extracted water.

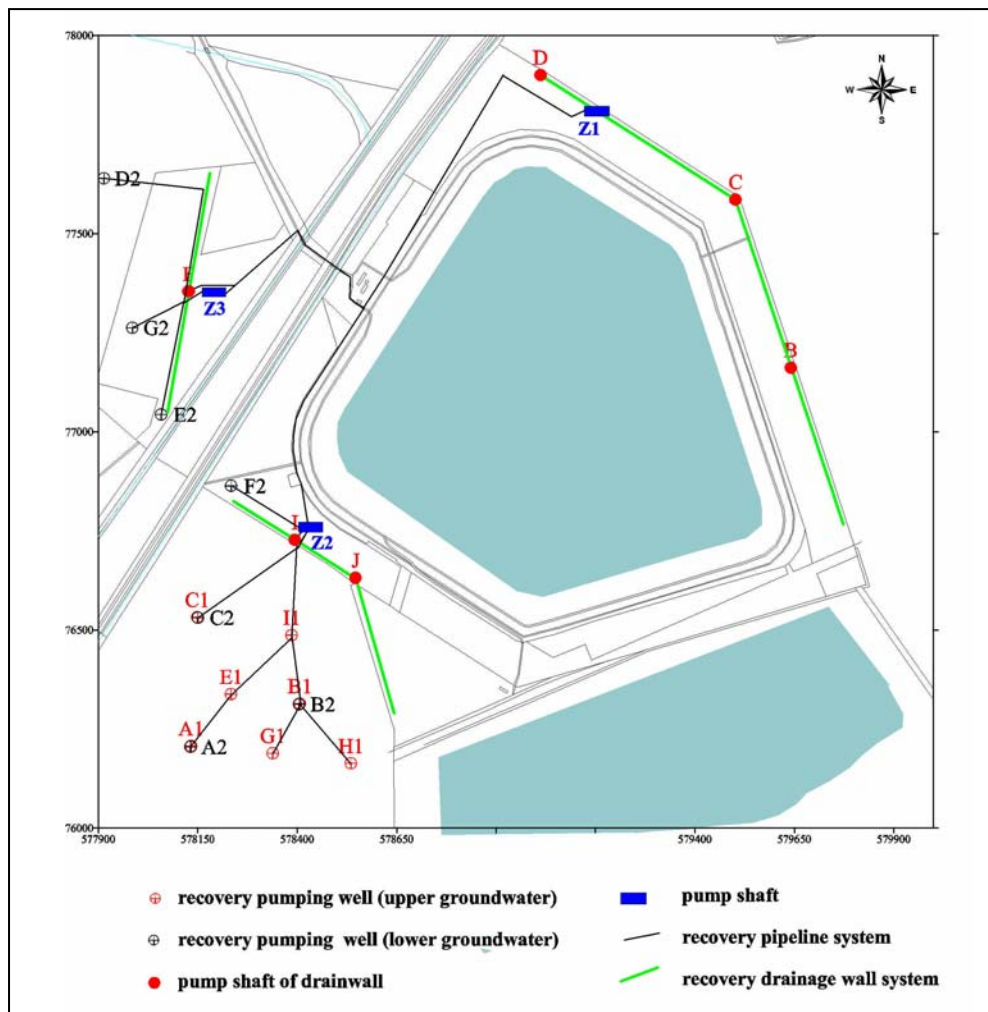

Fig. 8: Location of the groundwater extraction system.

The International Atomic Energy Agency (IAEA) sponsored the development of the water treatment technology. The facility was built on the area situated between the receiver *Pécsi Víz* and the northern foot of the tailings ponds N1.

Main steps of the water treatment are:

- € Collecting and mixing the water from the extracting wells in a basin
- € Removal of radium (if necessary) in a mixing tank by adding a  $\text{BaCl}_2$  solution (10 g  $\text{BaCl}_2/\text{l}$ )
- € Mixing with  $\text{Ca}(\text{OH})_2$
- € Thickening using HDT-process (high density thickening, recirculation some portion of underflow)
- € Filtration in continuous press filters
- € Deposition of sludge (mixture of  $\text{Mg}(\text{OH})_2$  and gypsum)

The above process is suitable for the removal of magnesium in form of hydroxide and sulphate in form of gypsum. Two years of experience show that the gypsum precipitation is a slow process, therefore some amounts of the gypsum escape the facility in soluble form. Nevertheless in average the TDS in the treated water decreases significantly from 10–12 g/l to 6–7 g/l. For the treatment approximately 4 kg  $\text{Ca}(\text{OH})_2/\text{m}^3$  is needed.

The water content of the sludge is approximately 50–55 %. The sludge is hauled in containers to waste rock pile N3, where an appropriate storage area has been shaped. Further decreasing of the TDS could be reached only by using physical methods, e.g. reverse osmosis. At the time being such expensive methods are not planned in the near future. Some photos of the water treatment station can be seen in Fig. 9.

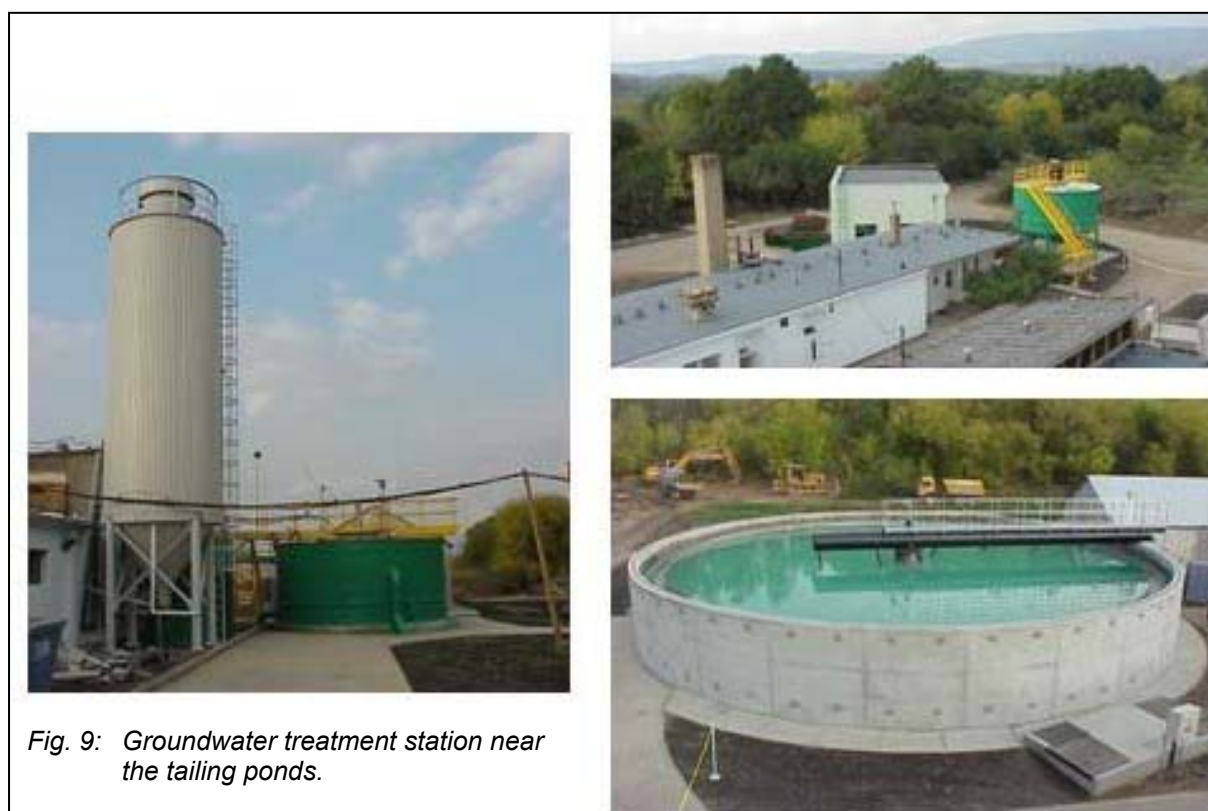

Fig. 9: Groundwater treatment station near the tailing ponds.

The water treatment station has been planned for ten years of operation but the real need for water treatment is not known at present.

### Stabilization of tailings ponds

Two tailings ponds were built by the company for mill tailings (Fig. 10). The total area covered with tailings is approximately 156 ha.



Fig. 10: Tailings ponds (one is in operation).

The tailings were disposed by hydrocyclones therefore the solid tailings had been segregated: in the central inner part the slime while in the dam the coarse sand had been sedimented. Therefore the water content of the solids and as a result the shear strength of the deposited material changes over a wide range.

Remediation of the tailings ponds means first of all their stabilisation to minimise the releases solid, liquid or airborne material from the tailings ponds. This can be achieved by covering the ponds. To do this the surface of the tailings ponds has to be stable enough to support the covering material. As a matter of fact the surface of the tailings ponds has appropriate stability only on the dam and in its close vicinity. The inner part of the tailings ponds which is often referred to as the 'slime core' has a very weak stability, expressed by low shear strength. Therefore the slime core has to be stabilised prior to covering.

The main tasks regarding the remediation of the tailings ponds were summarised in Fig. 6. The area of the tailings ponds (slime core) needs stabilisation using geomaterials. The method for stabilisation has been developed in the frame of a Phare project with participation of the German companies Wismut GmbH and C&E (Phare project, 1998).

Remediation of the tailings ponds is still underway. Remediation of tailings ponds N2 is near completion while the remediation of the tailings ponds N1 is in progress.

Some steps of the stabilisation of soft tailings are presented in Fig. 11. The soft tailings are covered with geotextiles, geogrid. Vertical drainage is used to accelerate the dewatering process. Next step is placing an interim cover with a good water conductivity. For this sand from reshaping of the dam is used. Role of this layer is loading of the water containing slime to initiate some dewatering under pressure and increase the shear strength of the slime, and at the same time to direct the pressed out water to the collecting well.

### **Multi-layer soil cover**

For long-term stabilisation (usually this means stabilisation at least for two hundred years) the reshaped and dewatered tailings have to be covered with non-radioactive material. The role of the covering material is to isolate the tailings from the environment, first of all to protect the airspace from Radon-222 and its progeny and the groundwater from liquid releases.

The licensing authorities usually determine the radon maximum flux and maximum water infiltration rate allowed in a given location. In our case for radon flux the limit is  $0.74 \text{ Bq/m}^2/\text{s}$  (internationally recommended value). On the uncovered tailings the radon flux is approximately  $4 \text{ Bq/m}^2/\text{s}$ . The external gamma-dose rate has to be decreased below background. For water infiltration the target value is  $40 \text{ mm/a}$  (precipitation is in average  $660 \text{ mm/a}$ ).

There are many different options for multi-layer covering. As a matter of fact both for radon retardation and the minimisation of water infiltration rate a clay sealing layer is the most promising approach.



Fig. 11: Covering of soft tailings using geomaterial and vertical drains.

For calculation of radon emissions from the pile the following equation is recommended (IAEA, 1992):

$$F_t = R \cdot \psi \cdot E \cdot (\zeta D_t)^{1/2}$$

$R$  is the radium-226 concentration in the tailings,  $\text{Bq/kg}$ ,

$\psi$  is the bulk density of tailings,  $\text{kg/m}^3$ ,

$E$  is the emanation coefficient (dimensionless),

$\zeta$  is the decay constant for radon-222 ( $2.06 \cdot 10^{-6} \text{ s}^{-1}$ ), and

$D_t$  is the diffusion coefficient for radon-222 in tailings,  $\text{m}^2/\text{s}$ .

The lower the diffusion coefficient the lower is the radon flux from the pile. Because the radon flux highly depends on the water content of the media (the higher the water content the lower is the diffusion coefficient), the covering system has to incorporate water-retarding layers. Such layers are most frequently made from clay or loess upgraded with bentonite. In our case (after field-testing) clay proved to be the most suitable material for sealing.

The parameters for the cover system were calculated using the HELP model, which proved to be very useful for the estimation of the effects resulting from changing the different input parameters (thickness of layers, vegetation, properties of soils, etc.) for infiltration rate. The calculations have been made at Wismut GmbH and Golder-Hungary Ltd. Finally the sequence of the covering layers as presented in Tab. 5 was accepted.

Tab. 5: Cover system on tailings pond N1.

	Layer type	Material
	Vegetation	Grass and bushes
<b>0.45 m</b>	Storage layer 1	Loess (degree of compaction $\Omega 90$ %)
<b>0.45 m</b>	Storage layer 2	Loess (degree of compaction 90 to 93 %)
<b>0.4 (0.3) m</b>	Protection layer	Compacted loess (degree of compaction $\sim 95$ %)
<b>0.3 m</b>	Sealing layer	Compacted clay (degree of compaction 95 to 97 %)

Total thickness of the cover is 1.6 m (on the slopes: 1.5 m). The first layer is the sealing layer composed of compacted clay (0.3 m). Above the sealing layer a protection layer from loess is built, also compacted to a thickness of 0.4 m. The next two layers are practically storage layers for vegetation which is extremely important for evaporation of the bulk of precipitation and erosion protection of the covered surface.

The compacted loess above the sealing layer protects the clay from penetration by plant roots. According to the model calculations it is expected that the infiltration rate will be at a level of 30–40 mm/a.

The partly remediated tailings pond N2 is shown in the Fig. 12. It can be seen that the tailings pond has been partly re-vegetated. The erosion gully needs maintenance in the first years.



Fig. 12: Remediation of tailings ponds (TP2).



## Research and development projects (PEREBAR project)

The Mecsekérc company has well equipped laboratories. Therefore the company participates in different research projects. One of the latest projects is the investigation of long-term behaviour of permeable reactive barriers in frame of an EU sponsored project (5<sup>th</sup> Framework Programme, project acronym PEREBAR). This work was led by the Department of Applied Geology of Karlsruhe University, Germany. Scientific leader was Prof. Dr. Kurt Czurda. The result of the project is an experimental reactive barrier built for in situ treatment of uranium contaminated groundwater. General information on the project can be found at its website at <http://www.perebar.bam.de>.

The experimental permeable reactive barrier (PRB) was built in 2002. Some construction steps are shown in Fig. 13. The dimensions of the PRB are: 6.8 m long, 3.9 m deep, 2 m wide. For the PRB a total of 38 t of elemental iron was used. The PRB was built using supporting frames.

The location of the experimental PRB in the valley *Zsid* (test field), with newly installed monitoring wells, is presented in Fig. 14. The cross-section of the experimental PRB is presented in Fig. 15.

In the last half-year detail monitoring was carried out on the test site. It was found that the experimental PRB is extremely effective in removing uranium from the local groundwater. Uranium concentration decreased in the PRB from the original concentration of approximately 1000 µg/l to below 10 µg/l.

A highly unfavourable effect observed in the experimental barrier is the formation of precipitates, caused by the increase of pH from 7 to 9–10. As a result the calcium concentration in the groundwater passing through the iron barrier drops significantly, as demonstrated in Fig. 16.



Fig. 13: Construction of the experimental PRB in *Zsid* valley near Pécs.



Fig. 14: Position of PRB with monitoring wells

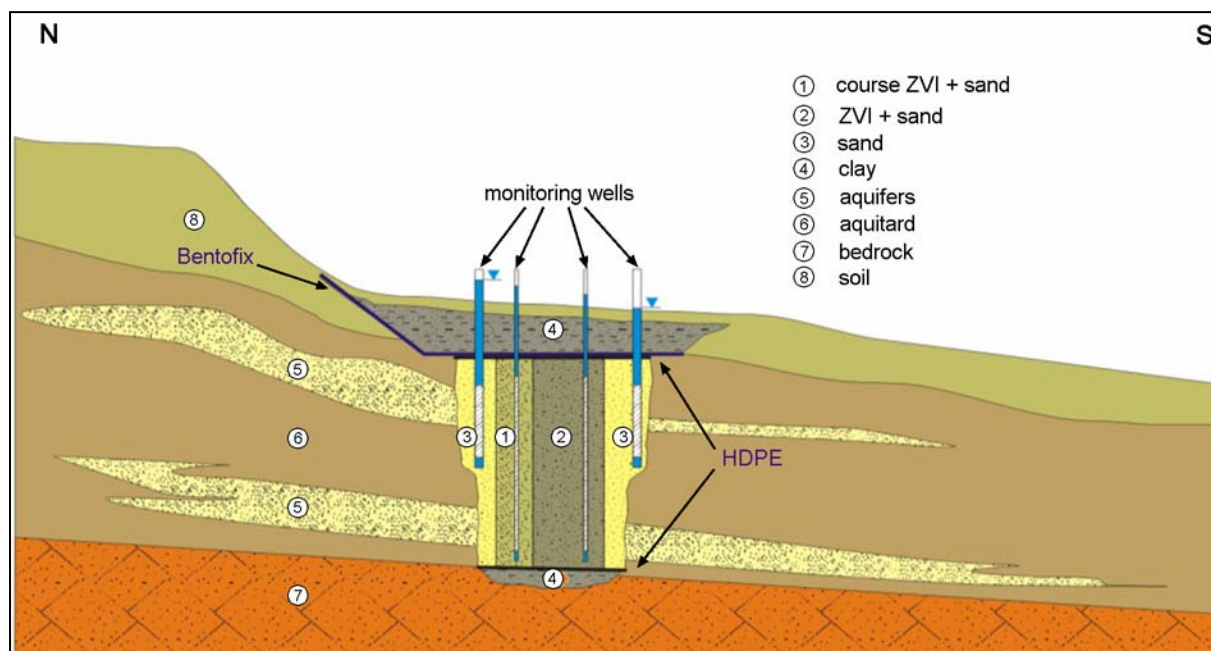

Fig. 15: Cross-section of the experimental PRB (Pécs, Hungary).

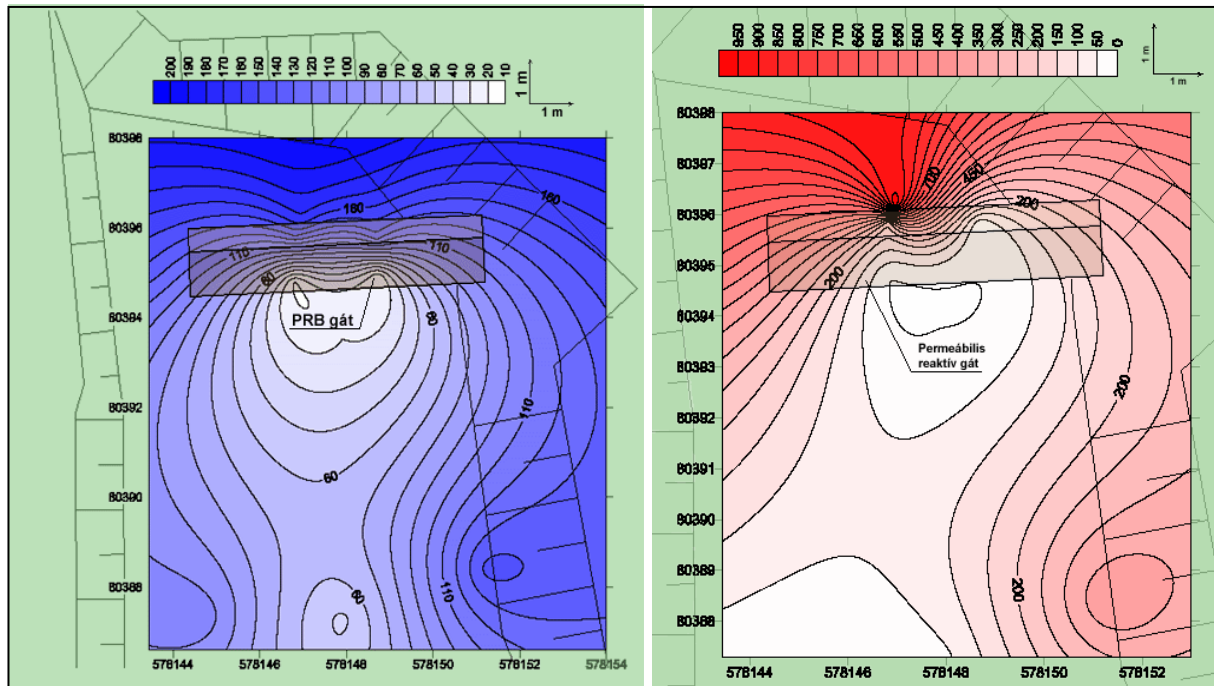

Fig. 16: Effect of the experimental PRB on calcium and uranium concentrations in groundwater.

Calcium and partly magnesium, as well as iron dissolved from the iron filling of the PRB are precipitated in form of carbonates. According to the calculation approximately 600–700 g of precipitates are formed when one cubic meter of water passes through the PRB. Question is how will these precipitates effect the long-term permeability of the PRB? It is expected that further monitoring will help to answer this question.

## Monitoring

All former uranium mining and processing related objects are being monitored. Also special monitoring stations in the nearby villages carry out continuous monitoring. In Fig. 17 monitoring data measured in village *Pellérd* (in close vicinity of the tailings ponds) are presented. It can be seen that the radon concentration sometimes reaches very high values (250 Bq/m<sup>3</sup> instead of the general 20–30 Bq/m<sup>3</sup> value). This is likely connected with changing of the air pressure, temperature, etc. Inhabitants of the village regularly are informed on the results of the measurements.

## Summary

- 1) For protection of groundwater and surface water the following water treatment methods are used:
  - € mine water treatment with removal of uranium in form of commercial-grade uranium concentrate which is sold
  - € pump-and-treat system for groundwater restoration in the vicinity of tailings ponds
  - € permeable reactive barrier for attenuation of uranium in seepage from waste rock pile
- 2) Experimental PRB with metallic iron sponge is installed for studying in situ treatment of contaminated groundwater.

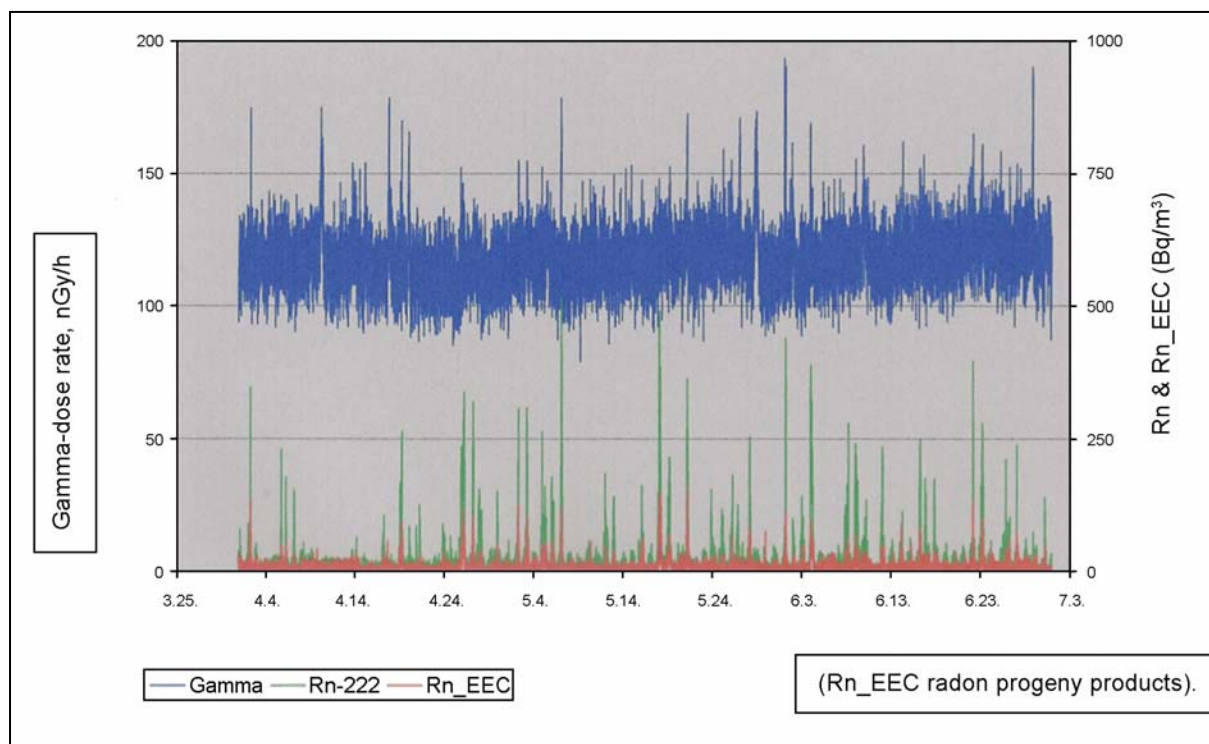

Fig.17: Radiological parameters measured in village Pellerd (1 km from tailings ponds) (Hungary, March–July 2002)

## References

- OECD-IAEA (2002): Uranium 2001: Resources, Production and Demand. OECD Paris.
- Pool, T. C. (2002): Technology and the uranium industry. IAEA, Vienna.
- Csövári, M., Csicsák, J. & Foelding, G.(2002): Investigation into calcium oxide-based reactive barriers to attenuate uranium migration. In: Simon, F.G., Meggyes, T. & McDonald, C. (eds.), Advanced groundwater remediation, Thomas Telford, London.
- Multi Country Environmental Programme. Phare Contract 98-01-70.00: "Tailings Ponds Remediation Planning"
- IAEA (1992): Current Practices for the Management and Confinement of Uranium Mill Tailings. Technical Report Series N. 335., IAEA, Vienna.

## Contact

Dr. Mihaly Csövári  
 Mecsekérc Rt, Hungary  
 Esztergár Lajos u. 19  
 7633 Pécs, Hungary  
 Phone: ++ 36 72 535 227; Fax: ++ 36 72 535 300  
 E-mail: csovarimihaly@mecsekerc.hu

## **MINE WATER REGULATION IN EUROPE: PRELIMINARY FINDING OF THE ERMITE PROJECT**

*J. Loredo, University of Oviedo, ES*

*Keywords: ERMITE; European Union; environment; mine water*

### **Abstract**

Some recent accidents of pollution associated to mining operations have demonstrated the inadequacy of the current technical, institutional and legislative framework in European countries in relation to mine water. Independently of these major accidents, up to now, no comprehensive mine water inventory for Europe has been made, albeit it is known, that in some areas, water stream are heavily polluted by mine water discharges. It is known too, that concerning mine water issues, the different European countries have different positions, both in relation to the extent of mine water problems and its legislative regulation (only some countries explicitly address mine water in its legislative framework). Given that the mine water is a part of the water natural cycle, its regulation would be addressed at an European level. In this sense, ERMITE project, funded by the European Commission Fifth Framework Programme, focuses on the environmental regulation of mine waters in the European Union through a multi-disciplinary point of view. The goal of the project is to provide to the Commission integrated policy guidelines (coherent with the catchment management approach defined by the Water Framework Directive and the sustainability principles enshrined in the Amsterdam Treaty) for developing European legislation and practice in relation to water management in the mining sector. In this sense, the development of a common European approach to mine water regulation taking into account the variety of regional and national conditions of in EU Member States and in countries from eastern Europe involved in the enlargement process, would contribute substantially to improve the environmental situation in industrialised (or formerly industrialised) catchments and set up the basis for a sustainable management of mine water. An overview of the key issues affecting the regulation of mine waters in the EU and potential accession states, analysed under different points of view (social, technical, economic, political and sustainability) and institutional research and legislation currently in force will be presented.

### **Introduction**

Short and long-term pollution from mines is still one of the most serious threats to the water environment in many Member States of the European Union, and the problem increases when non EU member states are taken into consideration. Recent large-scale contamination events in Europe such as Aznalcóllar (Spain) in 1998 or Baia Mare (Romania) in 2000, have alerted about the potential risks of water pollution by mine wastes and discharges from abandoned and active mines, and the sensitivity of many aquatic ecosystems to pollution. These accidents have demonstrated the inadequacy of the current technical, institutional and legislative framework within the EU.

Mine water pollution differs sufficiently from other forms of industrial pollution and it is necessary to have in mind that the impacts of mining in water resources occur not only at the different stages of the life cycle of the mine but after its closure. Then specific regulatory requirements quite distinct from those applicable to most other industrial processes must be considered. Although currently, mine water regulation varies from one country to another in the EU, given that the mine waters constitute a pan-European problem it seems that their regulation would be best addressed at EU level. A common European approach to mine water regulation in the development of the River Basin Management Plans arising from the Water Framework Directive would contribute substantially to the achievement of “good status” in mining or industrialised catchments.

## Objectives

The ERMITE project (ERMITE, 2001a) focuses on the environmental regulation of mine waters in the EU. The objective of the project is to elaborate a mine water inventory for Europe and to provide integrated policy guidelines for developing European legislation and practice in relation to water management in the mining sector. These guidelines need to be coherent with the catchment management approach defined by the Water Framework Directive and the sustainability principles enshrined in the Amsterdam Treaty.

The methodology applied for the achievements of these goals is:

- € Analysis of problems in relation to mine waters and integration of the variety of regional and national conditions in EU member states and in potential accession states.
- € Integration of disciplines such as environmental technology and management of mine waters, institutional structures and European law policies.

## Mine water problems

Mine waters are part of the water cycle but they are rarely treated as such in regulatory frameworks. This is despite the fact that short and long-term pollution is still one of the most serious threats to the water environment. There are substantial parts of rivers and even entire rivers which have effectively been removed from the inventory of fresh water resources due to mine water pollution. In some areas where water resources are already scarce (Southern Europe), this problem is particularly serious, growing in importance with the climatic change. All EU Member States are conscious of this problem but only some non EU member states are aware of mine water issues and its potential to contaminate the receiving water streams.

Despite the fact that in some areas of Europe water streams are or were heavily polluted by mine water discharges no comprehensive mine water inventory for Europe existed before ERMITE project. Then an European mine water inventory has been made and on the basis of national case studies in different areas of Europe a summary of the main water problems related to mine activities has been outlined (ERMITE, 2001b; ERMITE, 2002a).

Impacts of mining on water resources, both surface and groundwater, occur at various stages of the life cycle of the mine and after its closure. The mining process itself, mineral processing operations, mine dewatering, seepage of contaminated leachates, flooding of mine workings, and discharge of untreated waters, are some important processes with related mine water problems (Younger et al., 2002).

The mining process itself affects the loss of quality of the water environment, however this impact tends to be on a relatively localised scale when compared to other mining related impacts. The discharge of untreated mine water leads to important episodes of surface and groundwater pollution. Finally, the seepage of contaminated leachates from spoil heaps and tailing ponds is a significant cause of surface and groundwater pollution in many mining areas, with contamination taking place while the mine is operational and persisting long after the abandonment of the mine. There are abundant examples of unreclaimed spoil heaps releasing acidic leachates, which are polluting surface and groundwater. Other effects of mining operations on the water environment are the hydrological impacts associated to disruptions of groundwater systems and flow patterns, water table affection, alteration of flow rates, etc.

## EU policies and mining activities

Currently, there is no specific Community legislation regarding mining activity (Kroll et al., 2002; Loredo et al., 2002) and regulation and management of mine water differs substantially in the different European countries (ERMITE, 2002b; ERMITE, 2002c). The existing EU legal tools in relation to environmental issues of mining activities can be divided into two categories: Waste legislation, and other EU policies. Tab.1 enumerates the different Directives and remarks on important aspects related to mining activity.

Tab.1: European legislation.

EU WASTE LEGISLATION		
Directive 75/442, amended by Directive 91/156	Waste Framework Directive	Unclear whether it does cover mining waste or not (?). Art. 2: ... excluded where they are already covered by other legislation. Crux issue: national legislation or EU legislation ? (no specific EU legislation on this type of waste)
Directive 99/31	Landfill of Waste Directive	∅ Established with municipal waste disposal operations in mind. ∅ Tailing ponds not specifically considered.
OTHER EU POLICIES		
Directive 96/61	IPPC Directive	∅ Mineral extraction excluded from its coverage. Mineral processing is included. ∅ Majority of tailings ponds should fall within its ambit, although many mine waste handling activities probably will not. ∅ BAT Doc on mineral processing and tailings dams.
Directive 82/501 amended by Directive 96/82	Seveso I and II Directives	∅ Preventing accidents. ∅ Excludes from its field of application "extraction and mining activities" (art. 2(4)). ∅ Seveso II amended to unequivocally include mineral processing of ores, tailing ponds, dams. But only about major accident hazards.
Directive 85/37 amended by Directive 97/11	Environmental Impact Assessment Directive	∅ Adopts preventive actions. ∅ EIA needed for all projects. ∅ Includes mining and tailings dams.
Directive 76/464 and daughter Directives	Discharges into water of dangerous substances	∅ Regulate international, deliberate discharges to water (mining discharges included). ∅ They will be subsumed into the new Water Framework Directive (by 2013)
Directive 80/68	Groundwater Protection	∅ Intended to protect groundwater against pollution by certain "dangerous substances". ∅ It will be subsumed into Water Framework Directive (by end 2013).
Directive 2000/60	Water Framework Directive	∅ It seeks to manage water quantity, quality and ecology at the catchment scale. ∅ Implicitly covers mine waters but not operational, open to interpretation. ∅ Adopted year 2000. Limit to be transposed by Member States: 22/12/2003.

The analysis of the enumerated Directives proves that existing EU legislation does not cover properly the environmental aspects of mining. Indeed, many of the existing Directives explicitly excludes extraction and mining activities. It must be also considered that regulating only the mine waste facilities and not the mine voids misses the main pollutant source. If the full life-cycle of mining operations is considered, the post-closure phase is temporally dominant, but in practice this phase is poorly regulated.

In the wake of the recent mining accidents (Aznañcollar, Baia Mare, ...) the EU launched a number of initiatives as Baia Mare Task Force, which was charged with learning lessons from the events to guide future policy and practice. The findings of this Task Force highlighted the need for a critical review of the current status and future requirements of EU legislation related to mining activities. In parallel, proposals for amendments to existing legislation and possible introduction of new legislation related to mining pollution are in development. Current EU policies being prepared by the European Commission (Mining – Environment) are: Amendments of Seveso II Directive, Proposal for a Directive on Mining Waste, and BAT Doc on Management of Tailings and Waste-Rocks in Mining Activities.

The Seveso II Directive covers industrial accidents. It obliges operators to implement safety management systems., including details on risk assessment with possible accident scenarios. In the wake of the Baia Mare and Aznañcollar accidents, the Commission envisages amending Seveso II Directive so that it unequivocally includes mineral processing, including the use of tailing ponds. However, this Directive could only cover such activities if dangerous substances were present in quantities beyond the threshold levels set out in the Directive. The proposal for an amendment of the Seveso II Directive suggested that the amendments would focus on explosives and fireworks factories, mining wastes, carcinogens, and changes to the tonnage thresholds which brings installations holding chemicals classified as “dangerous for the environment” within the Directive’s scope.

The proposal for a Directive on mining waste is an important policy initiative. Mining waste is known to be among the largest waste streams in the EU. Some waste streams generated by non-ferrous metal mining industry contain large quantities of ecologically dangerous environmentally persistent metals. Since water is the major pathway for such contaminants, it is imperative that any new Directive clearly considers mine water questions. This proposal (EC, 2003a) seeks to improve the ways in which waste from the extractive industries is managed by setting minimum requirements and specifically addressing the environmental and human health risks that may arise from the treatment and disposal of such waste. It covers waste from all sectors of the extractive industry and specifically focuses on operational issues connected with waste management, prevention of soil and water pollution, and the stability of waste management facilities (in particular tailing ponds).

Although the IPPC Directive does not include mining “*per se*”, a special technical document based on best available techniques will be prepared on management of tailings and waste-rock in mining activities. This technical document was intended to inform operators of the environmental measures that can be taken to reduce pollution and pollution risk. The first Draft Document on BAT for Management of Tailings and Waste-Rock in Mining Activities was produced in September 2002, and recently it was developed the second Draft in May 2003 (EC, 2003b). Its objective is to reduce everyday pollution and to prevent or mitigate accidents in the mining sectors.



## Conclusions

A comprehensive mine water inventory for Europe has been made. From the ERMITE consortia's experiences and the studies conducted it can be assumed that about 10000 active, closed, or abandoned mines with polluted mine water discharges exist in the EU and the candidate countries. Concerning mine water issues, Europe does not have many things in common. This applies to both, the extend of mine water problems and the legislative regulation of mine waters. Regulation and management of mine water issues differ substantially from one country to another. The only countries that explicitly address mine water in the legislative framework seems to be the United Kingdom, Czech Republic and Austria, other countries regulate mine water within their mining and water legislation.

Mining activities still have many negative impacts on the environment. As regards mine water pollution, the general consensus is that the current legal regimes do not provide a sufficient level of environmental protection. The questioning of effectiveness and applicability of current legislation at regional, national and European levels has led the EC to put forward three main proposals legislation to adequately deal with environmental and social consequences of mining. Among those proposals is a draft proposal for a directive on waste from the extractive industry which include provisions for mine water pollution. The combination of new European environmental policy proposals with provisions for mine water pollution to a liability regime which would assign liability for an environmental damage caused is a promising solution to provide a high degree of environmental protection in regards to environmental impact from mining in Europe.

## References

- EC (1996a). Council Directive 96/61/EC of 24 September 1996 concerning Integrated pollution Prevention and Control.
- EC (1996b). Council Directive 96/82/EC of 9 December 1996, on the control on major-accidents hazards involving dangerous substances.
- EC (1997). Council Directive 97/11/EC of 3 March 1997 amending Directive 85/337/EEC on the assessment of the effects of certain public and private projects on the environment.
- EC (1999). Council Directive 99/31/EC of 26 April 1999, on the landfill of waste.
- EC (2000a). Commission of the European Communities, 2000: Communication from the Commission on safe operation of mining activities: a follow-up to recent mining accidents. COM (2000) 664 final.
- EC (2000b). Directive 2000/60/EC of the European Parliament and of the Council of 23 October 2000 establishing a framework for Community
- EC (2001). Proposal for a Directive of the European Parliament and of the Council amending Commission of the European Communities (2001). Council Directive 96/82/EC of 9 December 1996 on the control on major-accidents hazards involving dangerous substances. COM (2001) 624 final.
- EC (2003a). Commission of the European Communities. Proposal for a Directive of the European Parliament and of the Council on the management of waste from the extractive industries.
- EC (2003b). Draft Reference Document on Best Available Techniques for management of Tailings and Waste-Rock in Mining Activities, Draft Document.

- EEC (1976). Council Directive 76/464/EEC of 4 May 1976 on pollution caused by certain dangerous substances discharged into the aquatic environment of the Community action in the field of water policy.
- EEC (1979). Council Directive 80/68/EEC of 17 December 1979 on the protection of groundwater against pollution caused by certain dangerous substances.
- EEC (1991). Council Directive 91/156/EEC of 18 March 1991, amending Directive 75/442/EEC on waste.
- ERMITE (2001a). Environmental Regulation of Mine Waters in EU – Contract No. European Commission Fifth Framework Programme.
- ERMITE (2001b). Deliverable D1: National case studies.
- ERMITE (2002a). Deliverable D2: Overview of the EU and Eastern Europe.
- ERMITE (2002b). Deliverable D3: Institutional research.
- ERMITE (2002c). Deliverable D4: European policies and mine waters.
- Kroll, A., Amezaga, J.M., Younger, P.L., Wolkersdorfer, Ch. 2002. Regulation of mine waters in the European Union: Contribution of scientific research to policy development. *Mine Water and the Environment*, 21 (4), 193–200.
- Loredo, J., Amezaga, J.M., Kroll, A., Pérez, M., Ordóñez, A., Pendás, F. Younger, P. 2002. Hacia una propuesta de normativa a nivel europeo de regulación ambiental de aguas de mina. In: *Sustainable Development in the XXI Century. A Challenge of Engineering. XI International Congress on Industry, Mining and Metallurgy*. 421–423pp. Tiasa Gráfica. Barcelona.
- Younger, P.L., Banwart, S.A., Hedin, R.S. 2002. *Mine water. Hydrology, Pollution, Remediation*. Kluwer Academic Publishers. 442pp.

## Contact

Jorge Loredo  
University of Oviedo  
School of Mining Engineering  
Independencia 13, 33004 Oviedo, Spain  
Phone: ++34 985 10 42 95, Fax: ++34 985 10 42 45  
E-mail: jloredo@correo.uniovi.es

## ADDRESS LIST

### Organisers and Lecturers

#### Mr. David Banks

Holymoor Consultancy  
8 Heaton Street, Brampton  
Chesterfield, Derbyshire  
S40 3AQ United Kingdom  
Phone: +44-1246-23 00 68  
E-mail: david@holymoor.force9.co.uk

#### Mr. Mihaly Csövari (Dr.)

Mecsekérc Környezetvedelmy RT  
Esztergár Lajos u. 19  
Pécs HU  
7633 Hungary  
Fax: +36-72-535 300,  
Phone: +36-72-535 277  
E-mail: csovarimihaly@mecsekerc.hu

#### Mr. Jorge Loredo (Dr.)

Universidad de Oviedo  
Esc. de Minas  
C/. Independencia 13  
Oviedo, ES  
33004 Spain  
Fax: +34-985-10 42 45  
Phone: +34-985-10 42 95  
E-mail: jloredo@correo.uniovi.es

#### Mrs. Gundula Prokop

UBA, Austrian Federal Environment Agency  
Dept. for Contaminated Sites  
Spittelauer Laende 5  
Wien AT  
1090 Österreich  
Fax: +43-1-313 04 5911  
Phone: +43-1-313 04 5923  
E-mail: gundula.prokop@umweltbundesamt.at

#### Mr. Karl Ernst Roehl (Dr.)

Universitaet Karlsruhe  
Dept. of Applied Geology  
Kaiserstrasse 12  
Karlsruhe DE  
76128 Deutschland  
Fax: +49 (721) 606 279  
Phone: +49 (721) 608 7612  
E-mail: ke.roehl@agk.uni-karlsruhe.de

#### Mr. Christian Wolkersdorfer (Dr.)

TU Bergakademie Freiberg/Freiberg University  
of Mining and Technology  
Lehrstuhl für Hydrogeologie/Department of  
Hydrogeology  
Freiberg/Sachsen DE  
09596 Deutschland  
Fax: +49-3731-39 27 20  
Phone: +49-3731-39 33 09  
E-mail: c.wolke@tu-freiberg.de

#### Mr. Paul Younger (Prof.)

University of Newcastle  
Dept. of Civil Engineering & Geoscience  
Newcastle upon Tyne UK  
NE1 7RU United Kingdom  
Fax: +44 191 222 6669  
Phone: +44 191 222 7942  
E-mail: p.l.younger@ncl.ac.uk

### Participants

#### Mrs. Lena Alakangas

Lulea University of Technology  
Lulea SE  
97187 Sweden  
Fax: +46-920-49 16 97  
Phone: +46-920-49 13 96  
E-mail: lena.alakangas@sb.luth.se

#### Mrs. Maria da Graca Azevedo de Brito

Universidade Nova de Lisboa  
CIGA - Research Center for Applied Geo-  
sciences  
Quinta da Torre  
Monte Caparica PT  
2829-516 Portugal  
Fax: +351-21-294 83 49  
Phone: +351-21-294 83 49  
E-mail: mgb@fct.unl.pt

#### Mrs. Vera Biermann

BAM Federal Institute for Materials Research  
and Testing  
Laboratory IV.33 Remedial Engineering  
Unter den Eichen 87  
Berlin DE  
12200 Germany  
Fax: +49-30-81 04/14 37  
Phone: +49-30-81 04/38 54  
E-mail: vera.biermann@bam.de

**Mr. Igor Brodzinski**

Polish Geological Institute  
Upper Silesian Branch  
Krolowej Jadwigi 1  
Sosnowiec PL  
41-200 Poland  
Fax: +48-32-266 55 22  
Phone: +48-32-266 20 36  
E-mail: ibrodzinski@pigog.com.pl

**Mrs. Ewa Burszta-Adamiak**

Agricultural University of Wroclaw  
Institute of Building and Landscape Architecture  
pl. Grunwaldzki 24  
Wroclaw PL  
50-363 Poland  
Fax: +48-71-320 55 84  
Phone: +48-060-228 34 40  
E-mail: burszta@wp.pl

**Mrs. Claudia Cherubini**

Via Samuel Hahnemann 2  
Bari IT  
70126 Italy  
Fax: +39-080-548 18 78  
Phone: +39-33-568 81 198  
E-mail: claudia.cherubini@tiscalinet.it

**Mr. Christos Christofi**

Cyprus Geological Survey  
Lefkosia CY  
1415 Cyprus  
Fax: +357-22-31 68 73  
Phone: +357-22-30 92 45  
E-mail: gsd@cytanet.com.cy

**Mrs. Stephanie Croxford (Dr.)**

Brunswood Farm, Ible  
Grangemill, Matlock, Derbyshire UK  
DE4 4HS United Kingdom  
Fax: +44-1623-44 00 21  
Phone: +44-1629-65 09 69  
E-mail: croxford@imcgroup.co.uk

**Mr. Jozsef Csicsak**

Mecsekerc Environment Co.  
Esztergar L. u. 19  
Pecs HU  
7633 Hungary  
Fax: +36-72-56 47 08  
Phone: +36-72-56 47 78  
E-mail: csicsakjozsef@mecsekerc.hu

**Mr. Dragos Curelea**

ICPMRR-SA  
B-dul Carol I 68, sector 2  
Bucarest RO  
Romania  
Fax: +40-1-776 31 88  
Phone: +40-744 20 44 43  
E-mail: dragos03@k.ro

**Mr. Gabor Földing**

Mecsek Ore Environment Corp.  
Esztergar L.u. 19  
Pécs HU  
7633 Hungary  
Fax: +36-72-56 47 08  
Phone: 0036-72-56 48 66  
E-mail: foldinggabor@mecsekerc.hu

**Mr. Robert Formowicz**

Polish Geological Institute  
Upper Silesian Branch  
Krolowej Jadwigi 1  
Sosnowiec PL  
41-200 Poland  
Fax: +48-32-266 55 22  
Phone: +48-32-266 20 36  
E-mail: rform@pigog.com.pl

**Mrs. Reetta Frilander**

Finnish Environment Institute  
P.O.Box 140  
Helsinki FI  
00251 Finland  
Fax: +358-9-4030 08 80  
Phone: +358-9-4030 09 18  
E-mail: reetta.frilander@ymparisto.fi

**Mrs. Ana Rita Goncalves Neves Lopes Salgueiro**

Instituto Superior Tecnico  
CVRM - GeoSystems Centre  
Av. Rovisco Pais 1  
Lisboa PT  
1049-001 Portugal  
Fax: +351-21-841 74 42  
Phone: +351-21-841 72 47  
E-mail: rsalgueiro@alfa.ist.utl.pt

**Mr. Grzegorz Gzyl**

Central Mining Institute  
Dept. of Geology and Geophysics  
pl. Gwarkow 1  
40-166 Katowice  
Phone: +48-32-259 23 17  
E-mail: ggzyl@wp.pl

**Mr. Jiri Kostal (Dr.)**

Sudomerska 25  
Prague 3 CZ  
130 00 Czech Republic  
Fax: +420-2-22 717 496  
Phone: +420-2-22 711 347  
E-mail: kostal@age.sro.cz

**Mrs. Päivi Heikkinen**

Geological Survey of Finland  
P.O.Box 96  
Espoo FI  
02151 Finland  
Fax: +358-205-50 12  
Phone: +358-205-50 25 61  
E-mail: paivi.heikkinen@gsf.fi

**Mrs. Sirpa Kumpulainen**

Geological Survey of Finland  
P.O.Box 96, Betonimiehenkuja 4  
Espoo FI  
02151 Finland  
Fax: +358-20-550 12  
Phone: +358-20-550 25 68  
E-mail: sirpa.kumpulainen@gsf.fi

**Mr. Paul Herbst (Dr.)**

GWU Geologie-Wasser-Umwelt GmbH  
Bayerhamerstraße 57  
Salzburg AT  
5020 Österreich  
Fax: 0662 87636010,  
Phone: +43-662-876 36 012  
E-mail: paul.herbst@gwu.at

**Mr. Petr Kvapil (Dr.)**

AQUATEST a.s.  
Hustiska 133/49  
Liberec 9 CZ  
460 07 Czech Republic  
Fax: +420-485-15 26 52  
Phone: +420-485-15 26 11  
E-mail: kvapil@aquatest.cz

**Mr. Jesper Holm (Dr.)**

DHI  
Agern Alle 11  
Horsholm DK  
2970 Denmark  
Fax: +45-45-16 92 92  
Phone: +45-45-16 90 34  
E-mail: jeh@dhi.dk

**Mr. Konrad Miotlinski**

University of Silesia  
Dept. of Hydrogeology  
ul. Bedzinska 60  
Sosnowiec PL  
41-200 Poland  
Fax: +48-32-291 68 88  
Phone: +48-32-291 68 88  
E-mail: miotlins@wnoz.us.edu.pl

**Mr. Hagen Gunther Jung**

Lärchenstr. 1  
Hannover DE  
30631 Deutschland  
E-mail: jung@satt.org

**Mr. Bryan Penny**

67 Storth Lane, Kiveton Park  
Sheffield UK  
S26 5QS United Kingdom  
Fax: +44-1623-44 00 21  
Phone: +44-1623-44 46 11  
E-mail: pennyb@imcgroup.co.uk

**Mr. Claus Kohfahl**

Malteser Straße 74-100  
Berlin DE  
12249 Deutschland  
Fax: +49-30-838 70 740  
Phone: +49-30-838 70 383  
E-mail: kohfahl@zedat.fu-berlin.de

**Mr. Stephen Rees**

SRK Consulting  
Windsor Court, 1-3 Windsor Place  
Cardiff UK  
CF10 3BX United Kingdom  
Fax: +44-44-29 20 348 199  
Phone: +44-44-29 20 348 150  
E-mail: bree@srk.co.uk

**Mr. Tobias Rötting**

Pasaje Madrona Piera 22, segundo  
Barcelona ES  
08028 Spain  
Phone: +34-653-21 75 96  
E-mail: tobias.roetting@upc.es

**Mrs. Renata Santos (Dr.)**

Rua da Azenha 85  
Porto PT  
4200-112 Portugal  
Fax: +351-229 514 040  
Phone: +351-963 591 710  
E-mail: renata.santos@igm.pt

**Mrs. Petra Schlager**

Karlsruhe University  
Dept. of Applied Geology  
Kaiserstr. 12  
Karlsruhe DE  
76128 Deutschland  
Fax: +49-721-606 279  
Phone: +49-721-608 76 16  
E-mail: petra.schlager@agk.uni-karlsruhe.de

**Mrs. Joanna Skwarek**

ul. Kosynierow Gdynskich 67/1  
51-686 Wroclaw  
Poland  
Phone: +48 (71) 348 47 86  
Fax: +48 (71) 320 53 84  
E-mail: giowanna@polzka.owet.pl

**Mrs. Angelika Schoener**

Friedrich-Schiller-Universität Jena  
Inst. of Earth Sciences, Hydrogeology  
Burgweg 11  
Jena DE  
07749 Deutschland  
Fax: +49-3641-94 87 42  
Phone: +49-3641-94 87 48  
E-mail: angelika@geo.uni-jena.de

**Mr. Gabor Simoncsics**

Mecsekerc Environment Co.  
Boszorkany u.2  
Pécs HU  
7624 Hungary  
Fax: +36-72-56 47 08  
Phone: +36-30-368 79 35  
E-mail: simoncsicsgabor@mecsekerc.hu

**Mr. Marek Soltysiak**

University of Silesia  
Wydział Nauk o Ziemi US  
ul. Bedzinska 60  
Sosnowiec PL  
41-200 Poland  
Fax: +48-32-291 68 88  
Phone: +48-32-291 68 88  
E-mail: msoltysi@wnoz.us.edu.pl

**Mr. Marcin Zembal**

Polish Geological Institute  
Upper Silesian Branch  
Krolowej Jadwigi 1  
Sosnowiec PL  
41-200 Poland  
Fax: +48-32-266 55 22  
Phone: +48-32-266 20 36  
E-mail: mzembal@pigog.com.pl