

The terrestrial isopods (Isopoda: Oniscidea) of Greece. 25th contribution: The genus *Armadillidium* (Armadillidiidae) in the provinces Macedonia and Thrace¹

HELMUT SCHMALFUSS

Abstract

Based on the investigation of new collections, 14 species of *Armadillidium* are reported from the northern mainland of Greece (provinces of Macedonia and Thrace). Seven species are new to science (*A. jerrentrupii* n. sp., *A. pangaionum* n. sp., *A. petralonense* n. sp., *A. phalacronum* n. sp., *A. pieperi* n. sp., *A. sfenthourakisi* n. sp. and *A. tuberculatum* n. sp.). Four species were treated in previous contributions of this series. The diagnostic characters of ten species (including the seven new ones) are described and illustrated, most of them by SEM-photographs, and the Greek records of these species are mapped.

Key words: Isopoda, Oniscidea, *Armadillidium*, northern Greece.

Zusammenfassung

Die Untersuchung neuer Aufsammlungen ergab 14 *Armadillidium*-Arten auf dem nordgriechischen Festland (Provinzen Makedonien und Thrakien). Sieben dieser Arten sind neu für die Wissenschaft (*A. jerrentrupii* n. sp., *A. pangaionum* n. sp., *A. petralonense* n. sp., *A. phalacronum* n. sp., *A. pieperi* n. sp., *A. sfenthourakisi* n. sp. und *A. tuberculatum* n. sp.). Vier Arten wurden in vorangehenden Beiträgen dieser Serie behandelt. Die diagnostischen Merkmale der sieben neuen und drei weiterer Arten werden beschrieben und illustriert, die meisten mit Hilfe von REM-Aufnahmen, und die griechischen Nachweise dieser Arten werden kartiert.

Contents

1	Introduction	153
2	Methods	154
3	The genus <i>Armadillidium</i> in Macedonia and Thrace	154
3.1	<i>Armadillidium album</i> Dollfus, 1887	154
3.2	<i>Armadillidium bicurvatum</i> Verhoeff, 1901	159
3.3	<i>Armadillidium fossuligerum</i> Verhoeff, 1902	159
3.4	<i>Armadillidium insulanum</i> Verhoeff, 1907	164
3.5	<i>Armadillidium janinense</i> Verhoeff, 1902	164
3.6	<i>Armadillidium jerrentrupii</i> n. sp.	169
3.7	<i>Armadillidium marmoratum</i> Strouhal, 1929	170
3.8	<i>Armadillidium pangaionum</i> n. sp.	174
3.9	<i>Armadillidium petralonense</i> n. sp.	179
3.10	<i>Armadillidium phalacronum</i> n. sp.	183
3.11	<i>Armadillidium pieperi</i> n. sp.	189
3.12	<i>Armadillidium sfenthourakisi</i> n. sp.	189
3.13	<i>Armadillidium tuberculatum</i> n. sp.	196
3.14	<i>Armadillidium vulgare</i> (Latreille, 1804)	200
4	References	200

1 Introduction

In the first part of this new revision of the Greek species of *Armadillidium* (SCHMALFUSS 2006a) the species from the Peloponnese were treated. Presently 18 species are known from the peninsula, six of them were described as new. The second part contains the species living on the Aegean islands (SCHMALFUSS 2006b). It comprises 13 species, none of which was new. Six of them also occur on the

Peloponnese, so they were treated in the first part. The present third part is dedicated to the species of the northern Greek mainland, comprising the provinces of Macedonia and Thrace (Fig. 1). This region is, concerning isopods, obviously the most underinvestigated part of Greece, seven of the 14 *Armadillidium* species recorded from there are new to science. Four of the species have been treated in the previous two contributions, so descriptions, illustrations and maps are given for ten species. With the new

¹ 24th contribution see Stuttgarter Beiträge zur Naturkunde, Serie A (Biologie) 698 (2006).

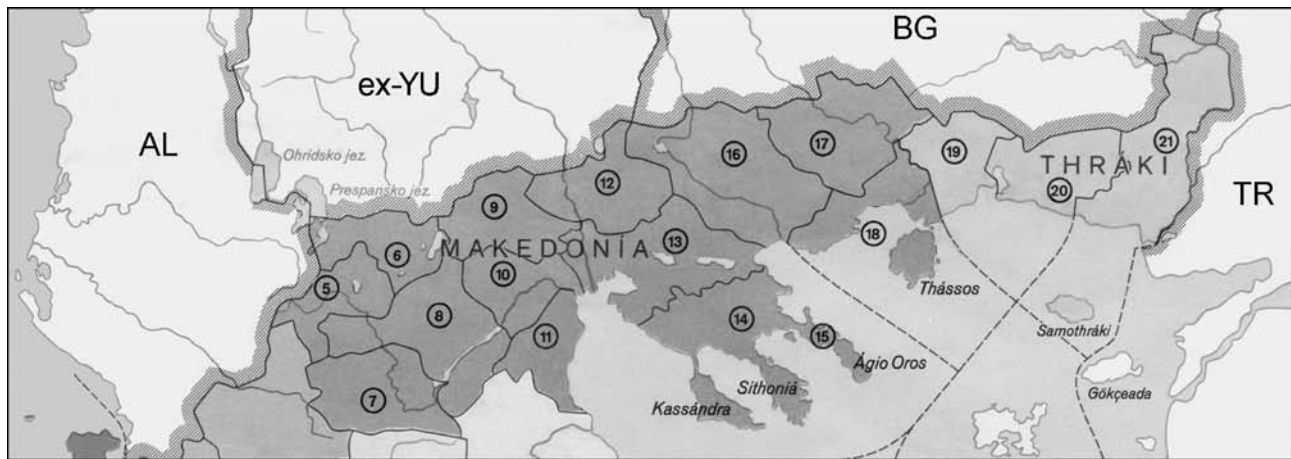

Fig. 1. Map of the treated area consisting of the northern Greek provinces Macedonia and Thrace. – The numbers indicate the political districts (nomoi) which are used to localize the collecting data: 5 = Kastoriá, 6 = Flórina, 7 = Grevená, 8 = Kozáni, 9 = Péla, 10 = Imathía, 11 = Pieriá, 12 = Kilkís, 13 = Thessaloníki, 14 = Khalkidikí, 15 = Ágio Oros, 16 = Sérres, 17 = Dráma, 18 = Kavála, 19 = Xánthi, 20 = Rodópi, 21 = Évros.

species described in the present publication the total sum of valid species described from Greece adds up to 57. This number will increase, because the material from the remaining regions of Greece contains more new species.

Abbreviations

A.	<i>Armadillidium</i>
AL	Albania
BG	Bulgaria
ex.	example(s), specimen(s)
ex-YU	former Yugoslavia
GR	Greece
SMNS	Staatliches Museum für Naturkunde Stuttgart
TR	Turkey

Acknowledgments

The following persons have donated isopod material used in this revision: Dr. B. BAEHR [formerly HOFFMANN] (South Brisbane/Australia), Dr. M. BAEHR (Munich/Germany), D. BARTSCH (SMNS), Dr. E.-G. BURMEISTER (Munich/Germany), Dr. F. ERHARD (Enzklösterle/Germany), Dr. R. GRIMM (Tübingen/Germany), S. HUBER (Oberuhldingen/Germany), Dr. J. KONTSCHÁN (Budapest/Hungary), Prof. Dr. W. KÜHNELT † (Vienna/Austria), Dr. H. MALICKY (Lunz am See/Austria), Dr. C. MANICASTRI (Rome/Italy), Prof. Dr. J. MARTENS (Mainz/Germany), Dr. G. OSELLA (L'Aquila/Italy), Dr. H. PIEPER (Kiel/Germany), A. & F. RIEDEL (Kalambáka/Greece), O. RUNZE (Kiel/Germany), Dr. W. SCHAWALLER (SMNS), J. SCHÖNFELD (Westum/Germany), Dr. S. SFENTHOURAKIS (Pátra/Greece), Dr. G. STEINBRÜCK (Tübingen/Germany).

Dr. K. WOLF-SCHWENNINGER and S. LEIDENROTH (both SMNS) operated the scanning electron microscope, and J. REIBNITZ and Dr. H.-P. TSCHORSNIG (both SMNS) edited the SEM-photographs and the maps.

Dr. S. SFENTHOURAKIS (Pátra/Greece) and Dr. S. TAITI (Florence/Italy) made valuable suggestions to improve an earlier draft of the manuscript.

To all of them I wish to express my sincere thanks.

2 Methods

The material used for the SEM-preparations was, if not stated otherwise, air-dried. In some cases a critical point treatment was used. If the number of specimens was not very limited I tried to find “clean” material for the SEM-preparations and prepared several specimens to be able to choose the cleanest one for the publication. In some species where the number of specimens was very restricted (e.g. *A. pieperi*) I had to use material covered with mud-particles, which nevertheless shows the relevant characters. Ultrasound treatment did not help to clean mud-covered material. The mounted material was coated with a 20 nm Au/Pd layer and examined with an ISI-SS40 scanning electron microscope at 10 KV. Digital photographs were directly acquired by using DISS 5 (point electronic).

3 The genus *Armadillidium* in Macedonia and Thrace

3.1 *Armadillidium album* Dollfus, 1887 (Figs. 2–12, map Fig. 13)

Literature records

No literature records from Greece. A general treatment of the species is found in VANDEL (1962: 841), a complete bibliographic list in SCHMALFUSS (2003: 27).

Material examined (including first records for Greece)

Greece: 15 ex., northeastern mainland, prefecture Rodópi, 7 km SW of Xilaganí, W of Ímeros harbor, sandy beach, under logs deeply buried in the sand, leg. SCHMALFUSS, 24.IV.1994 (SMNS 2421). – 1 ex., Ionian Islands, island Zákynthos, 10 km SE of Zákynthos, sandy beach, leg. ERHARD, 15.V.1996 (SMNS 2576).

Italy: 1 ex., Sicily, Siracusa, Pantano Grande N of Pachino, leg. R. GRIMM, 19.IV.1984 (SMNS 7218).

France: 2 ex., Mediterranean coast, S of Arles, Les Saintes

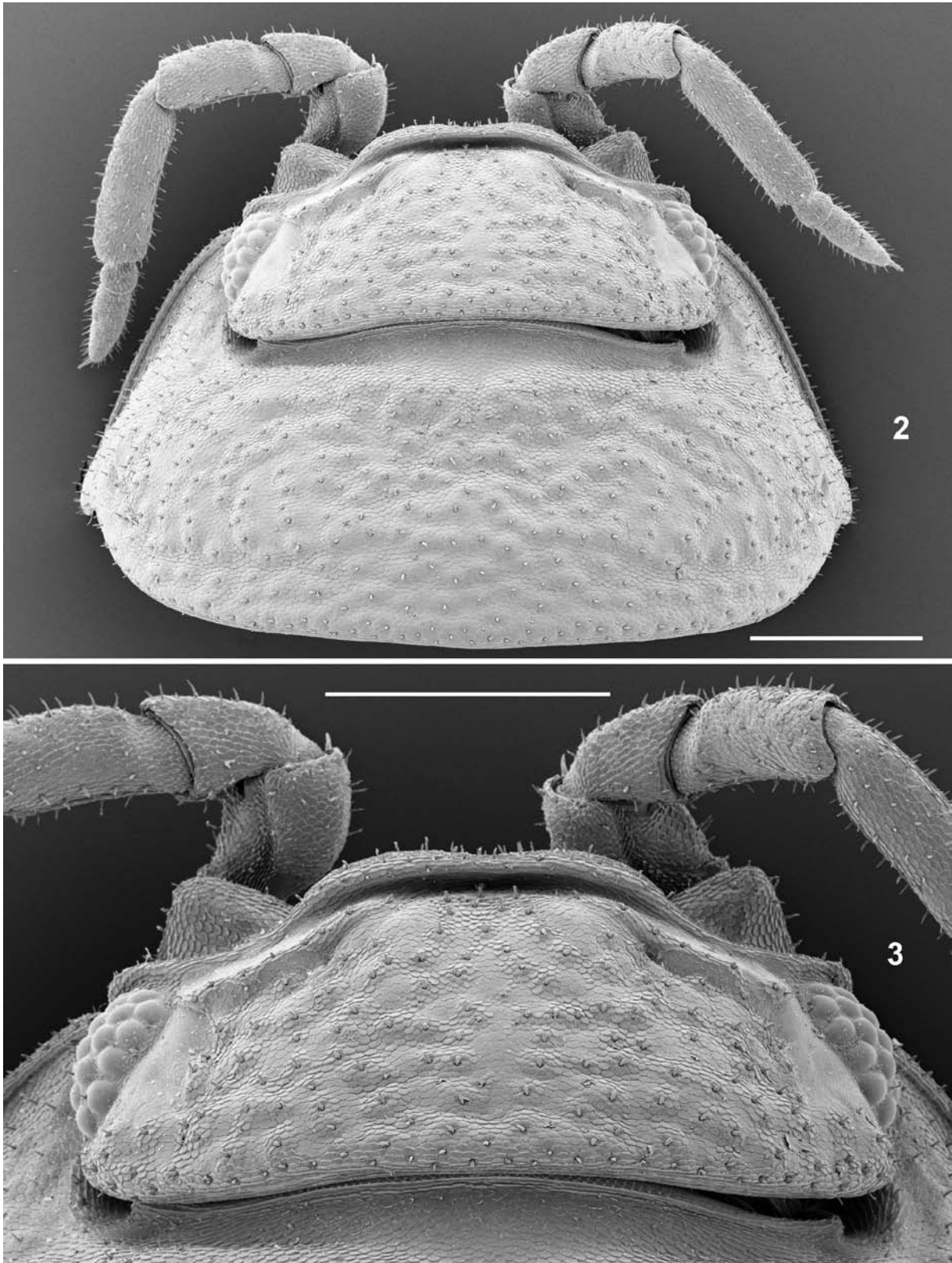

Figs. 2–3. *Armadillidium album* (northeastern Greece, SMNS 2421), ♀ with marsupium, 6.4×2.3 mm, critical point dried. – 2. Head and pereion-tergite 1, dorsal view. 3. Head, dorsal view. – Scales: 0.5 mm.

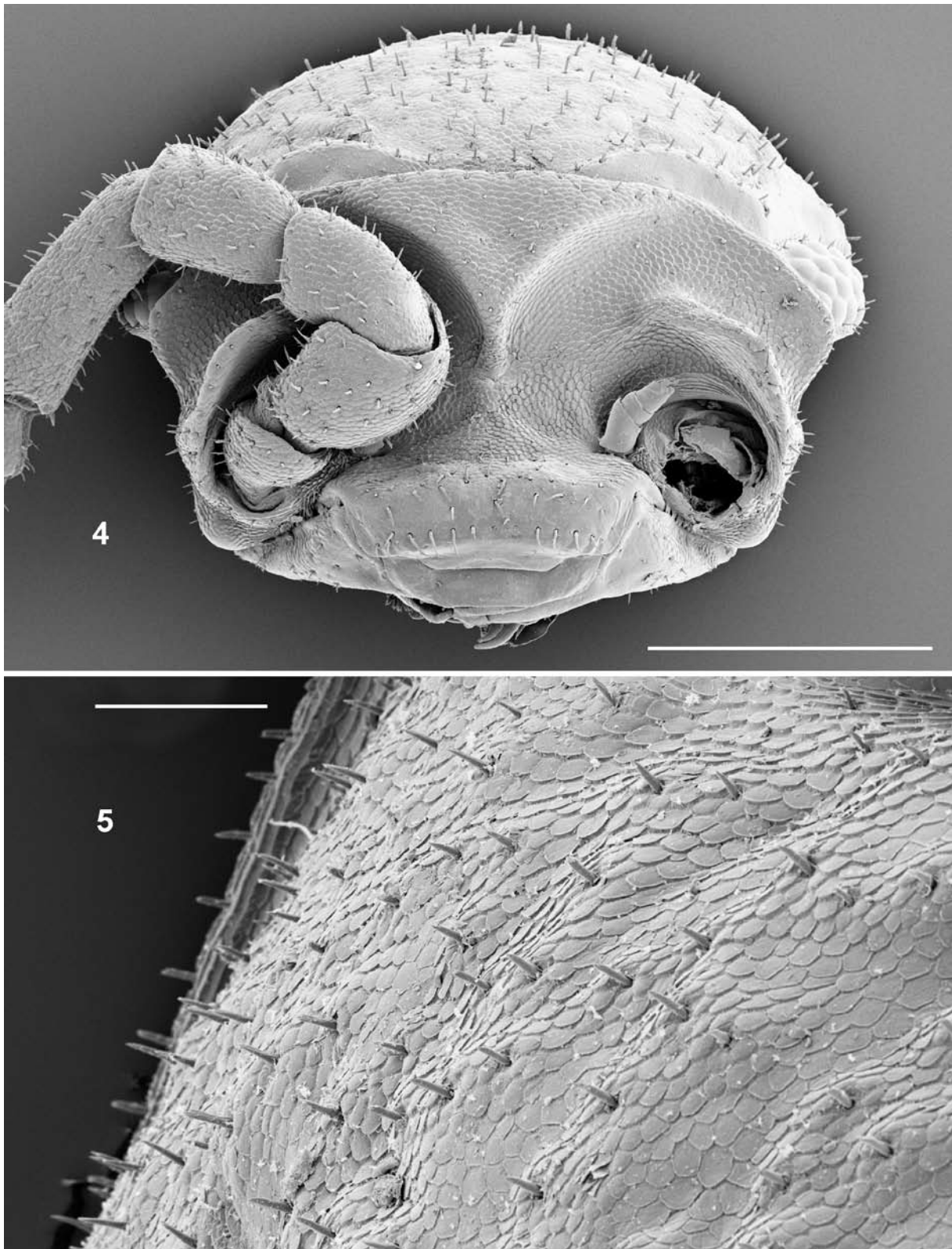

Figs. 4–5. *Armadillidium album* (northeastern Greece, SMNS 2421). – 4. ♂, 5.2 × 2.0 mm, head, frontal view. 5. ♀ with marsupium, 6.4 × 2.3 mm, critical point dried, detail of pereon-tergite 1. – Scales: 0.5 mm (4), 0.1 mm (5).

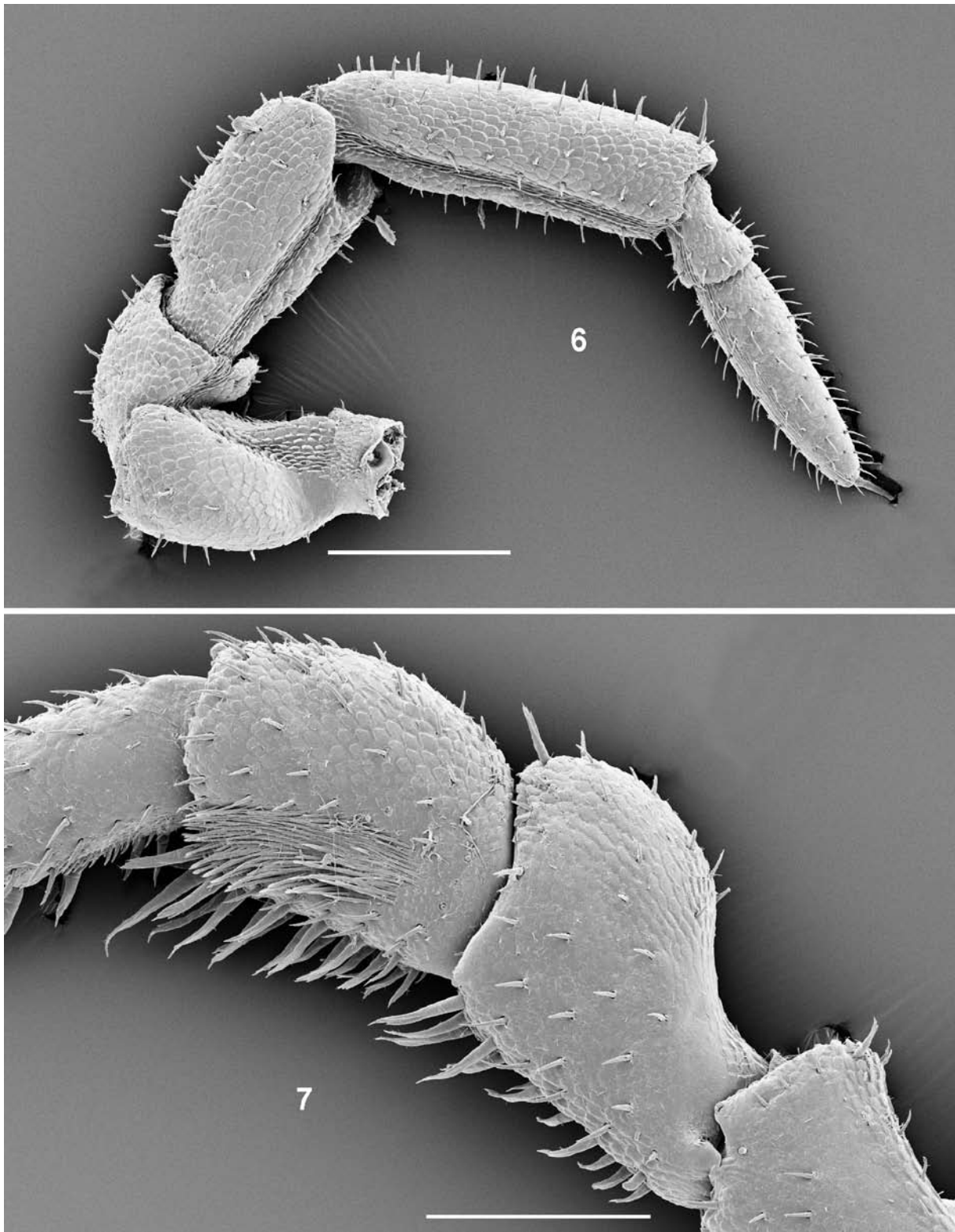

Figs. 6–7. *Armadillidium album* (northeastern Greece, SMNS 2421). – 6. ♂, 4.4×1.7mm, critical point dried, antenna. 7. ♂, 5.2×2.0mm, pereopod 1, frontal view. – Scales: 0.2mm.

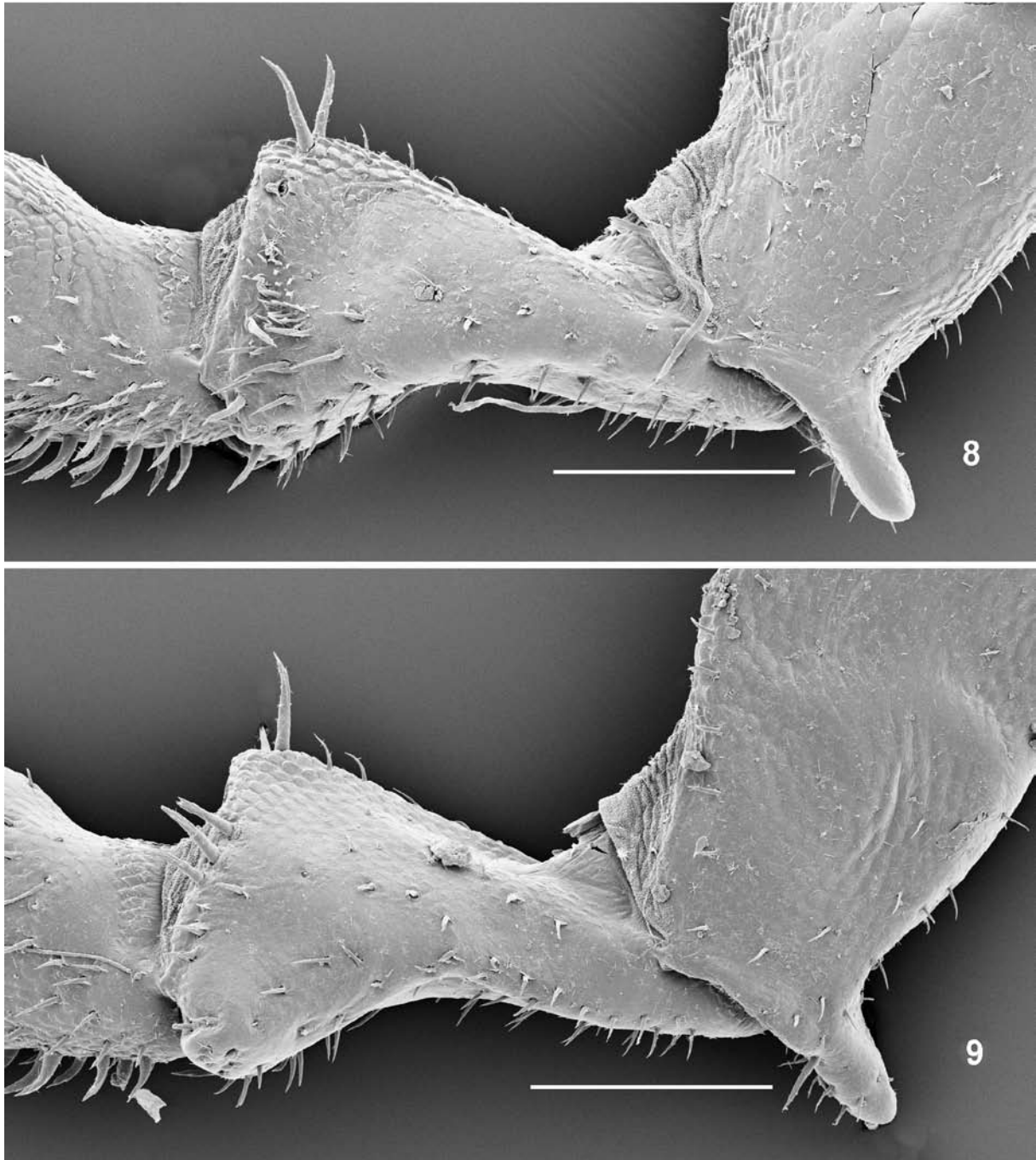

Figs. 8–9. *Armadillidium album* (northeastern Greece, SMNS 2421), ♂, 5.2×2.0 mm. – 8. Ischium 7, frontal view. 9. Ischium 7, caudal view. – Scales: 0.2 mm.

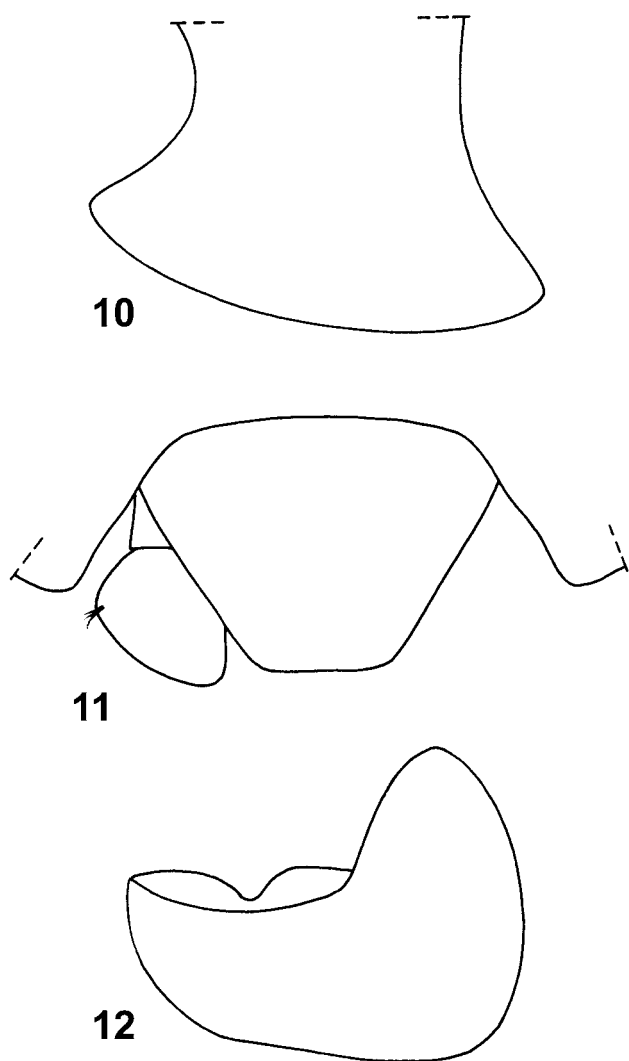

Figs. 10–12. *Armadillidium album* (northeastern Greece, SMNS 2421). – **10.** ♀, 7.2 × 3.0 mm, pereion-epimeron 1, lateral view. **11.** ♀, 7.2 × 3.0 mm, telson and uropod, dorsal view. **12.** ♂, 5.5 × 2.3 mm, pleopod-exopodite 1, dorsal view.

Maries de la Mer, beach, leg. BURMEISTER, 20.V.1978 (SMNS 3063).

Spain: 1 ex., Mediterranean coast, province Gerona, Ampurias, leg. M. BAEHR & B. HOFFMANN, 10.IV.1981 (SMNS 9106). – 24 ex., Atlantic coast, Cantabria, Laredo, Oriñon, sandy beach, leg. ERHARD, 3.I.1996 (SMNS 9316).

Madeira: 1 ex., Porto Santo, Ponta, leg. R. GRIMM, 18.XII.1986 (SMNS 15365).

Tunisia: 1 ex., Nabeul, leg. SCHÖNFELD, 16.IV.2001 (SMNS 15566).

Diagnostic characters

Maximum dimensions: 7.2 × 3.0 mm.

Coloration: Reduced pigmentation, yellowish with epimera partly light gray-brown.

Cuticular structures: Tergites slightly granulated, with short upright spiny setae (compare Fig. 5).

Head of duplocarinate type, with the ridge forming the upper edge of the frontal triangle extended to the sides of the head (Fig. 4) as in *A. bicurvatum* (SCHMALFUSS 2006a: 22, fig. 42). Frontal shield from behind surpassing frontal margin of head only slightly, upper margin straight, no angles laterally (Figs. 2–3); antennal lobes trapezoidal (Fig. 4). Hind margin of pereion-epimeron 1 completely rounded (Fig. 10). Telson shorter than wide, with straight sides and broadly truncated apex (Fig. 11). Antenna short and stout (Fig. 6), flagellum with distal segment about three times as long as proximal one. Male pereiopod 1 with brush of short spines on carpus and merus (Fig. 7); male pereiopod 7 with ischium ventrally concave, basipodite distally with very conspicuous process (Figs. 8–9). Male pleopod-exopodite 1 with rounded triangular hind-lobe and indented respiratory field (Fig. 12), endopodite 1 with apex bent outwards.

Distribution

The species is known from the coast of the northern and southwestern Mediterranean (the present paper contains the first records from Greece, see map Fig. 13) and the Atlantic coasts of Europe north to England and the Netherlands. It has also been found on Madeira.

Remarks

In contrast to all other members of the genus the species lives in marine supra-littoral sandy beaches, where it is found on wooden logs and trunks deeply buried in the sand.

3.2 *Armadillidium bicurvatum* Verhoeff, 1901

This species was treated in the 23rd contribution of this series (SCHMALFUSS 2006a). It is known from the western parts of Greece including the Peloponnese and western Crete and has also been found in southern Albania.

3.3 *Armadillidium fossuligerum* Verhoeff, 1902 (Figs. 14–23, map Fig. 24)

Literature records (all from Greece)

VERHOEFF 1902: 250 (Southern mainland, Timfristós Mountain); VERHOEFF 1907: 484; SCHMALFUSS 1981: 283, figs. 35–41 (Timfristós Mountain); SCHMALFUSS 1985: 291 (Timfristós Mountain and Parnassós Mountain).

Material examined

Greece: 8 ex., southern mainland, prefecture Viotia, Delfi, 400 m, leg. BARTSCH, 30.VI.2005 (SMNS 2868). – 20 ex., as before, Parnassós Mountain, 1200–1800 m, leg. MALICKY,

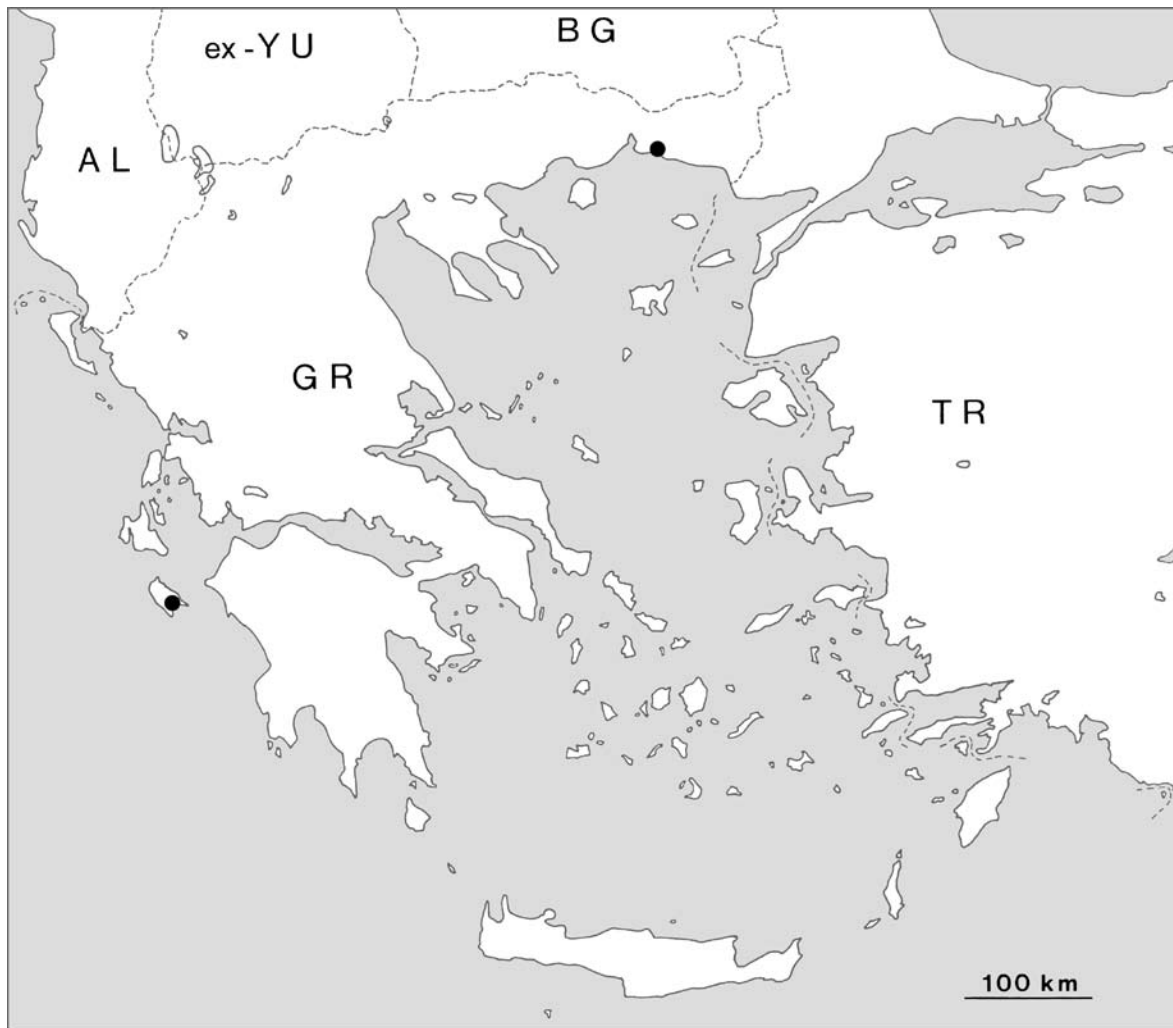

Fig. 13. Greek records of *Armadillidium album*.

22.IV.1984 and leg. SCHMALFUSS, 11.X.2000 (SMNS 2101, 2680, 2681). – 1 ex., southern mainland, prefecture Etolía Akarnanía, Lake Trichonída, Pámfi, leg. SCHMALFUSS, 7.X.2000 (SMNS 2671). – 25 ex., southern mainland, prefecture Evritanía, Panetolikó Mountain, near Prussós, 1000–1200 m, *Abies*, leg. MALICKY, 25.V.1987 and leg. SCHMALFUSS, 10.X.2000 (SMNS 2474, 2679). – 64 ex., as before, Timfristós Mountain, above Karpenísi, 1000–1600 m, *Abies*, leg. SCHMALFUSS, 28.–29.IX.1989 and 10.X.2000 (SMNS 2219, 2221, 2677, 2678). – 7 ex., central mainland, prefecture Trikala, Kalambáka, Kastaniá, 1300–1500 m, leg. A. & F. RIEDEL, 26.V.2001 (SMNS 2705). – 23 ex., northern mainland, prefecture Imathía, Vértmio Mountain, 7 km SW of Véria, 600 m, maquis and deciduous forest, leg. SCHAWALLER & SCHMALFUSS, 2.V.1994 (SMNS 2413). – 4 ex., northern mainland, prefecture Péla, Vértmio Mountain, 10 km S of Édessa, 500 m, deciduous forest, leg. SCHMALFUSS, 1.V.1994 (SMNS 2429). – 2 ex., northern mainland, prefecture Imathía, Piéria Mountains, Rizómata, leg. PIEPER & RUNZE, 7.X.1978 (SMNS 1892). – 1 ex., northern mainland, Ólimpos Mountain, Fotiná, river shore with *Platanus*, leg. SCHMALFUSS, 30.IV.1979 (SMNS 1134). – 1 ex., top of Ólimpos Mountain, Skólio, leg. KÜHNELT, 28.VII.1973 (SMNS

1809). – 4 ex., Ólimpos Mountain, between Pétra and Kokinopilós, leg. RUNZE, 10.V.1977 (SMNS 1772). – 1 ex., northern mainland, prefecture Thessaloníki, Lake Korónia, Evangelismós, leg. SCHMALFUSS, 14.V.1990 (SMNS 2264). – 3 ex., northern mainland, prefecture Sérres, Meníkio Mountain, Khionokhóri, 700 m, leg. PIEPER, 11.V.2002 (SMNS 2745). – 2 ex., as before, Kerkíni Mountains, Áno Poría, 1000 m, leg. STEINBRÜCK, 20.V.1988 (SMNS 2182). – 21 ex., as before, Kerkíni Mountains, above Platanákia, mixed forest, 500 m, leg. SCHMALFUSS, 13.V.1990 (SMNS 2258). – 18 ex., as before, Kerkíni Mountains, above Platanákia, *Fagus*, 800–1400 m, leg. SCHMALFUSS, 18.IX.1988 and 13.V.1990 (SMNS 2242, 2259, 2260). – 27 ex., as before, Lake Kerkíni, Lithótopos, leg. STEINBRÜCK, 24.V.1988 and leg. SCHMALFUSS, 23.X.2005 (SMNS 2186, 2871, 2872).

Ex-Yugoslavian Macedonia: 5 ex., southern part, river Vardar, Demir Kapija, leg. KONTSCHÁN et al., 17.X.2006 (SMNS 5059). – 9 ex., southeastern part, Belasica Mountains (continuation of the Kerkíni Mountains to the west), Kolešino, ruderal vegetation, 300 m, leg. KONTSCHÁN et al., 18.X.2006 (SMNS 5085).

Bulgaria: 11 ex., SW-Bulgaria, Pirin Mountains, 25 km S of

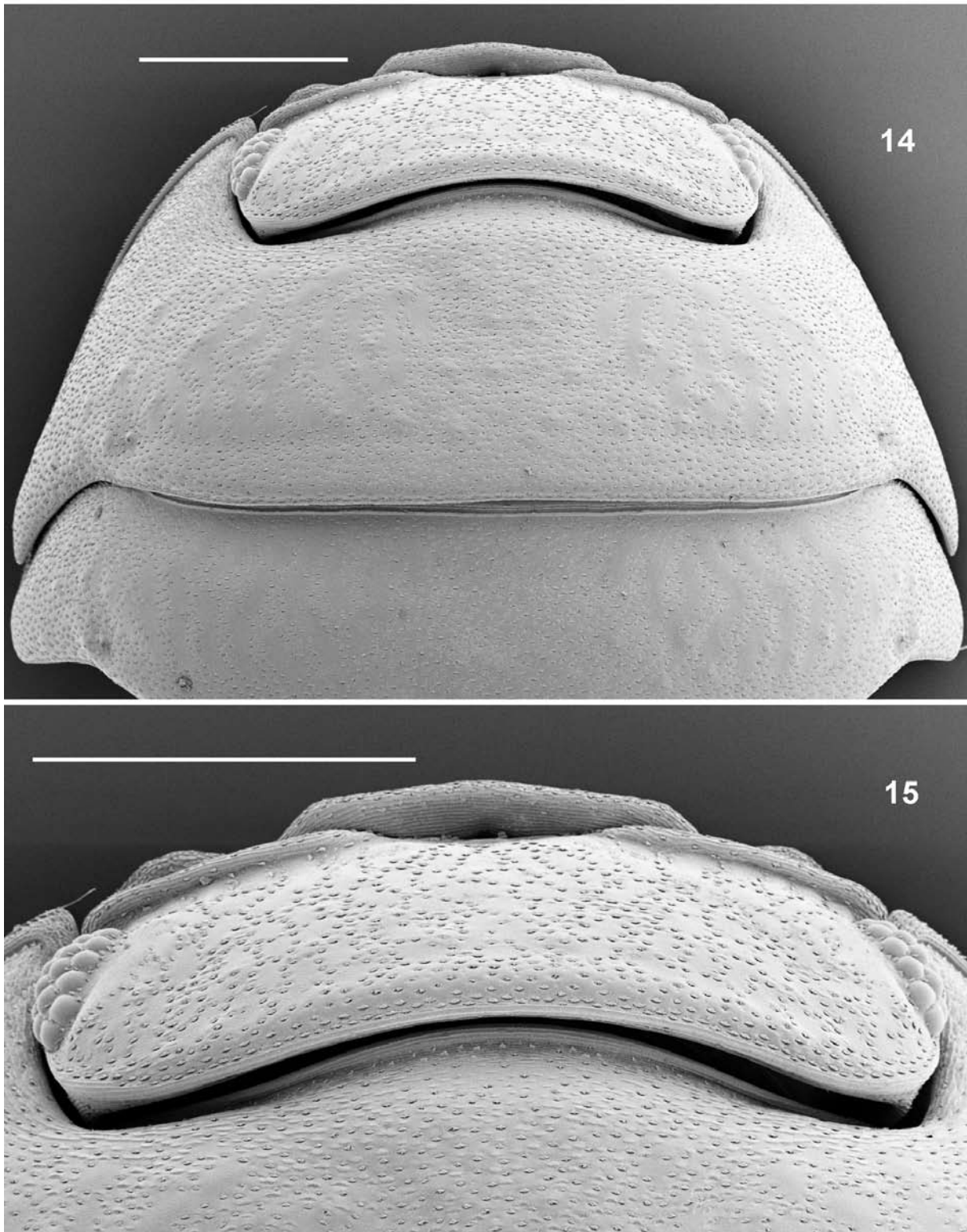

Figs. 14–15. *Armadillidium fossuligerum* (northern Greece, Vértio Mountain, SMNS 2413), ♂, 11.5×4.5 mm. – 14. Head and pereion-tergite 1, dorsal view. 15. Head, dorsal view. – Scales: 1 mm.

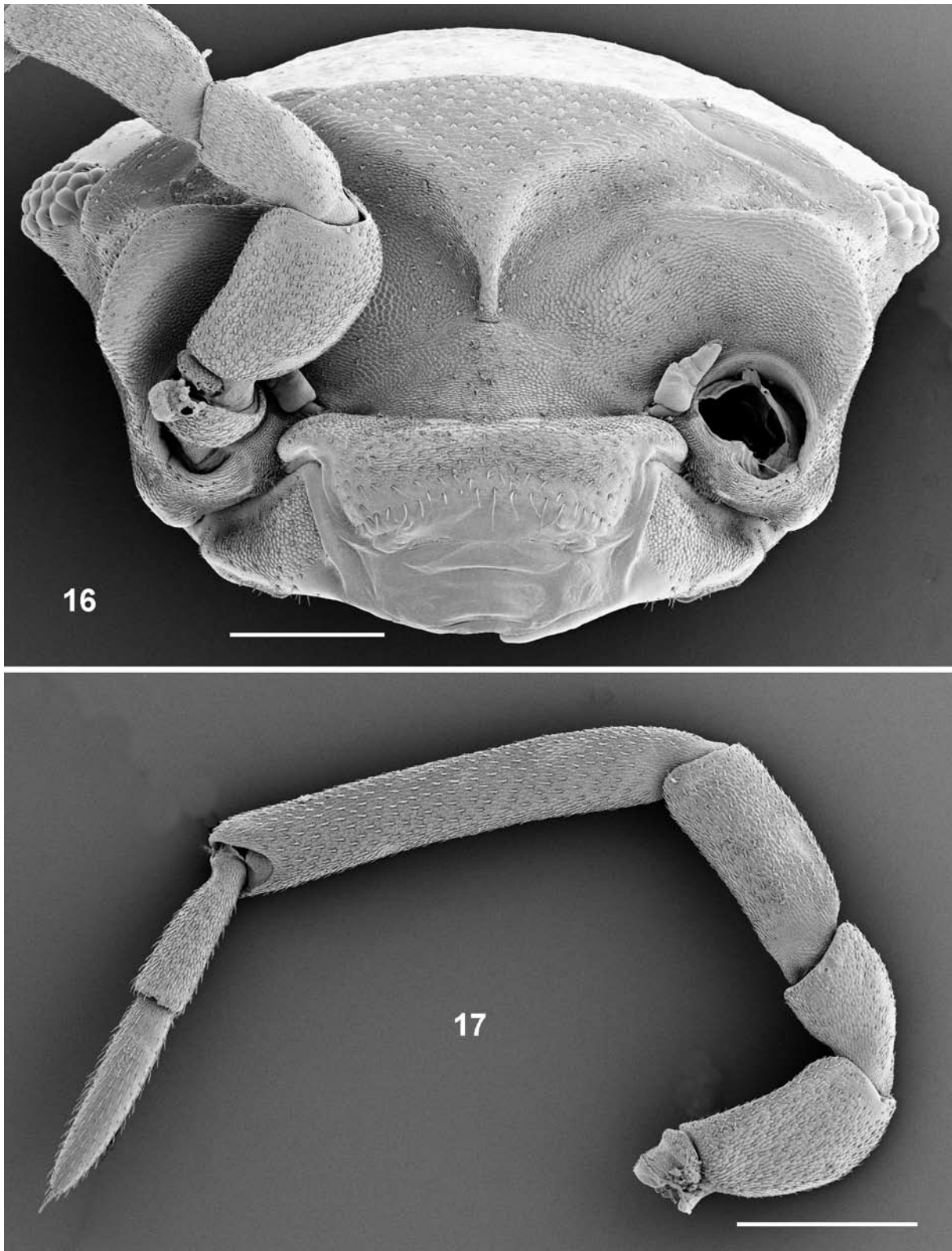

Figs. 16–17. *Armadillidium fossuligerum* (northern Greece, Vérnio Mountain, SMNS 2413). – 16. ♀, 13.5×6.0 mm, head, frontal view. 17. ♂, 11.5×4.5 mm, antenna. – Scales: 0.5 mm.

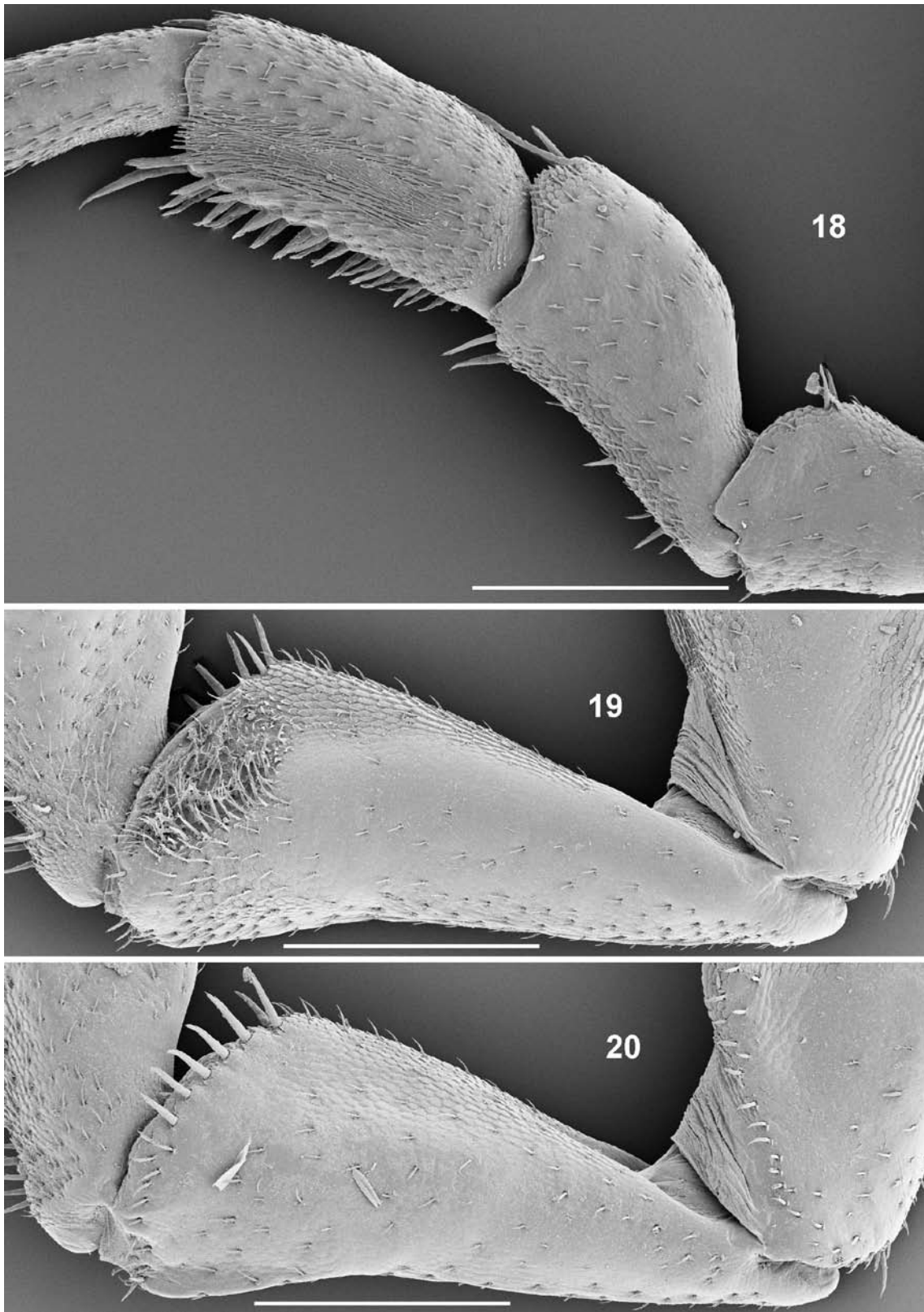

Figs. 18–20. *Armadillidium fossuligerum* (northern Greece, Vértio Mountain, SMNS 2413), ♂, 11.5×4.5 mm. – 18. Pereiopod 1, frontal view. 19. Ischium 7, frontal view. 20. Ischium 7, caudal view. – Scales: 0.4 mm.

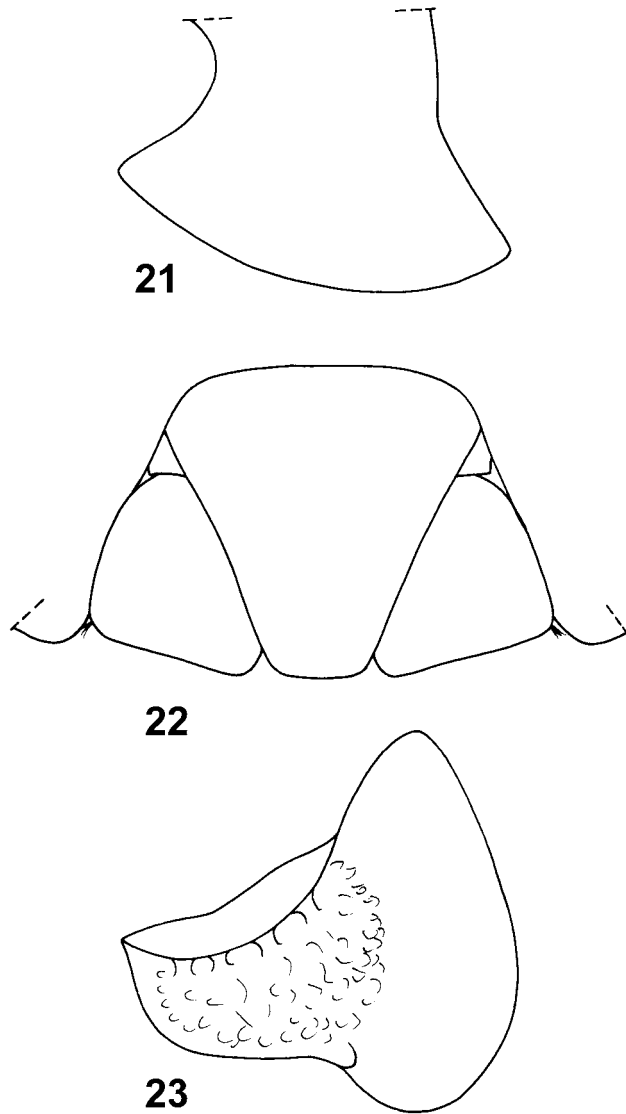

Figs. 21–23. *Armadillidium fossuligerum* (northern Greece, Vêrmio Mountain, SMNS 2413), ♂, 11.5×4.5 mm. – **21.** Pereion-epimeron 1, lateral view. **22.** Telson and uropods in situ, dorsal view. **23.** Pleopod-exopodite 1, dorsal view.

Blagoevgrad, 600 m, leg. S. HUBER, 5.VIII.2005 (SMNS 5554). – 25 ex., SW-Bulgaria, N of Blagoevgrad, 550 m, leg. S. HUBER, 6.VIII.2005 (SMNS 5558). – 17 ex., SW-Bulgaria, 30 km N of Blagoevgrad, Rila Monastery, edge of forest, 850 m, leg. S. HUBER, 6.VIII.2005 (SMNS 5559).

Diagnostic characters

Maximum dimensions: 15×7 mm.

Coloration: Tergites grayish brown, epimera lighter, bigger specimens often uniformly blackish.

Cuticular structures: Variable, tergites smooth to granulated (Fig. 14). It seems that specimens from higher altitudes are less granulated.

Frontal shield from behind surpassing frontal margin of head in a varying degree, upper margin nearly straight to rounded, oblique angles laterally (Fig. 15); antennal lobes trapezoidal (Fig. 16). Hind margin of pereion-epimeron 1 with obtuse angle (Fig. 21). Telson as wide as long, with nearly straight sides and truncate apex (Fig. 22). Antenna see Fig. 17, distal segment of the flagellum slightly longer than proximal one. Male carpus 1 with brush of short spines (Fig. 18); male ischium 7 ventrally slightly concave, frontally with distal hair-field (Figs. 19–20). Male pleopod-exopodite 1 with triangular hind-lobe which can vary in length (Fig. 23), endopodite 1 with apex straight.

Distribution

Distributed in the mountain regions in southwestern Bulgaria, southeastern ex-Yugoslavian Macedonia and in a central belt through the Greek mainland (map Fig. 24).

Remarks

The species exhibits, according to its rather wide distribution, some morphological variation in the diagnostic characters, there is, however, no evidence for dividing it into different species.

3.4 *Armadillidium insulanum* Verhoeff, 1907

This species was treated in the 24th contribution of this series (SCHMALFUSS 2006b). It is known from the Aegean islands (except the Dodekánisa and Crete), the northeastern coast of Asia Minor and the northeastern mainland of Greece (map in SCHMALFUSS 2006b: 31, fig. 71).

3.5 *Armadillidium janinense* Verhoeff, 1902 (Figs. 25–33, map Fig. 34)

Synonym: *A. epirense* Strouhal, 1956.

Literature records (all from Greece)

VERHOEFF 1902: 252 (Northwestern mainland, Ioánnina); VERHOEFF 1930: 55, figs. 66–67; STROUHAL 1956: 604, figs. 29–34 (*A. epirense*, northwestern mainland, province Ípiros, many localities); SCHMALFUSS 1981: 287, figs. 62–68; SCHMALFUSS 1985: 295, map fig. 13 (Northwestern mainland, prefectures Préveza, Thesprotía and Ioánnina); SFENTHOURAKIS 1992: 159 (prefecture Ioánnina, Timfi Mountain).

Material examined

Greece: 18 ex., southern mainland, prefecture Evritanía, Timfristós Mountain, above Karpenísi, 1500 m, *Abies*, leg. SCHMALFUSS, 28.IX.1989 (SMNS 2220). – 1 ex., northwestern mainland, province Ípiros, Voidomátis, leg. SFENTHOURAKIS, 19.V.1990 (SMNS 2311). – 1 ex., northwestern mainland, prefecture Ioánnina, Anthokhóri SW of Métésovo, leg. KÜHNELT,

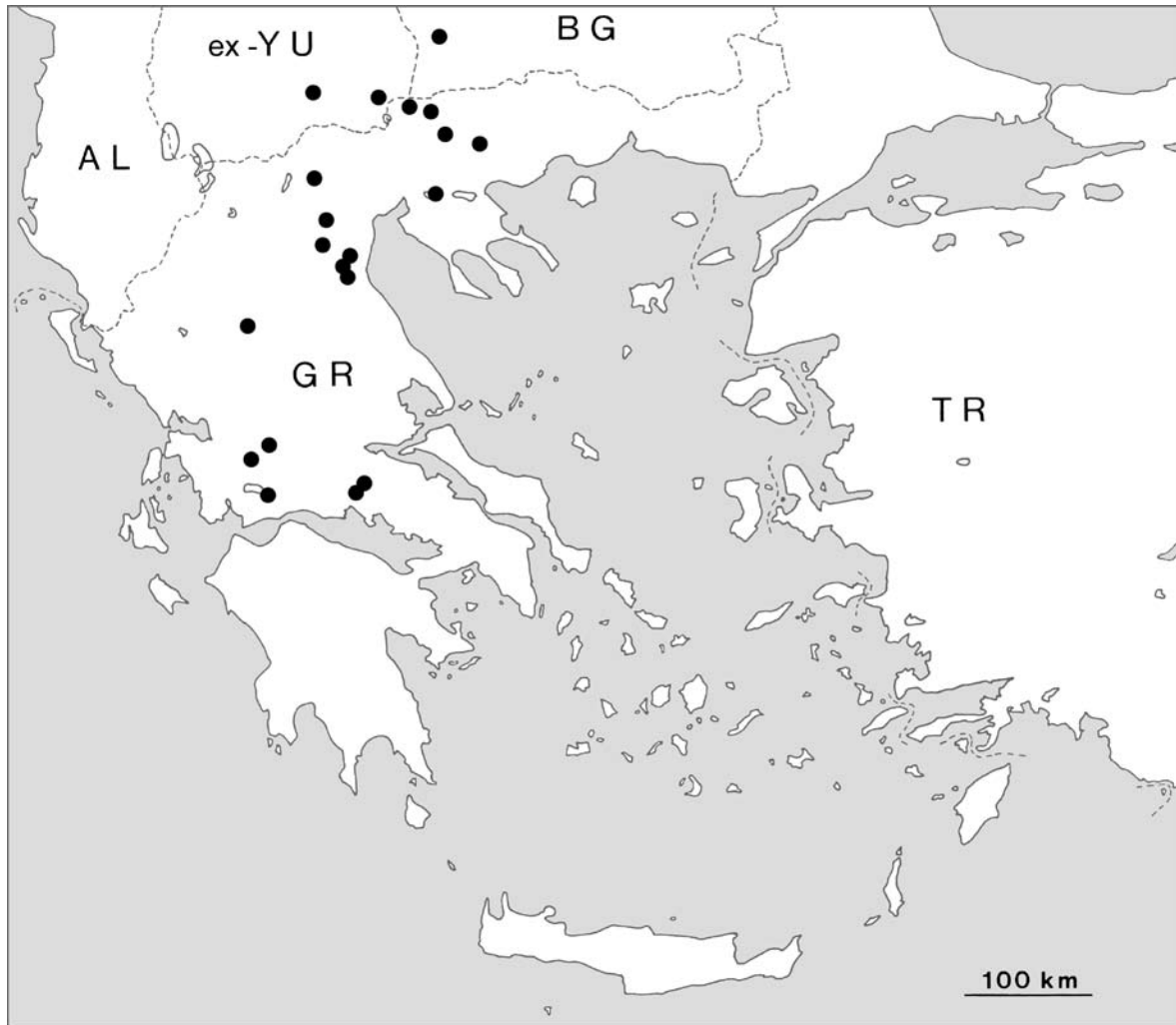

Fig. 24. Records of *Armadillidium fossuligerum*. Additional record from southwestern Bulgaria north of the area covered by the map.

15.VII.1968 (SMNS 1860). – 2 ex., prefecture Ioánnina, Métsovo, below Katára-Pass, 1300 m, *Fagus*, leg. KONTSCHÁN et al., 13.V.2006 (SMNS 1004). – 9 ex., prefecture Ioánnina, Tímfi Mountain, near Pápigko, 900 m, deciduous forest, leg. SFENTHOURLAKIS, 25.IX.1989 (SMNS 2751), leg. SCHAWALLER & SCHMALFUSS, 5.V.1994 (SMNS 2411). – 1 ex., Tímfi Mountain, entrance to Víkos Gorge N of Arísti, 400 m, leg. SCHMALFUSS, 5.V.1994 (SMNS 2415). – 1 ex., Tímfi Mountain, Monodéndri, 1000–1500 m, leg. BARTSCH, 21.VI.2005 (SMNS 2869). – 2 ex., north-western mainland, prefecture Grevená, eastern part of Smólikas Mountain, Samarína, 1400 m, leg. KONTSCHÁN et al., 14.V.2006 (SMNS 1434).

Diagnostic characters

Maximum dimensions: 16.0 × 7.7 mm.

Coloration: Light brown with epimera lighter, big males uniformly blackish.

Cuticular structures: Tergites smooth or very slightly granulated (Fig. 25).

Frontal shield from behind surpassing frontal margin of head, upper margin rounded, no angles laterally, caudally with conspicuous groove (Fig. 25); antennal lobes trapezoidal (Fig. 26). Hind margin of pereion-epimeron 1 completely rounded (Fig. 31). Telson wider than long and with broadly rounded apex (Fig. 32). Antenna see Fig. 27, distal segment of the flagellum slightly longer than proximal one. Male pereopod 1 with dense brush of spines on carpus and merus (Fig. 28); male ischium 7 ventrally slightly concave, frontally with large S-shaped distal hair-field, caudal side with ventral and proximal hair-fields, basipodite 7 with hairy setae along medial margin (Figs. 29–30). Male pleopod-exopodite 1 with short hind-lobe,

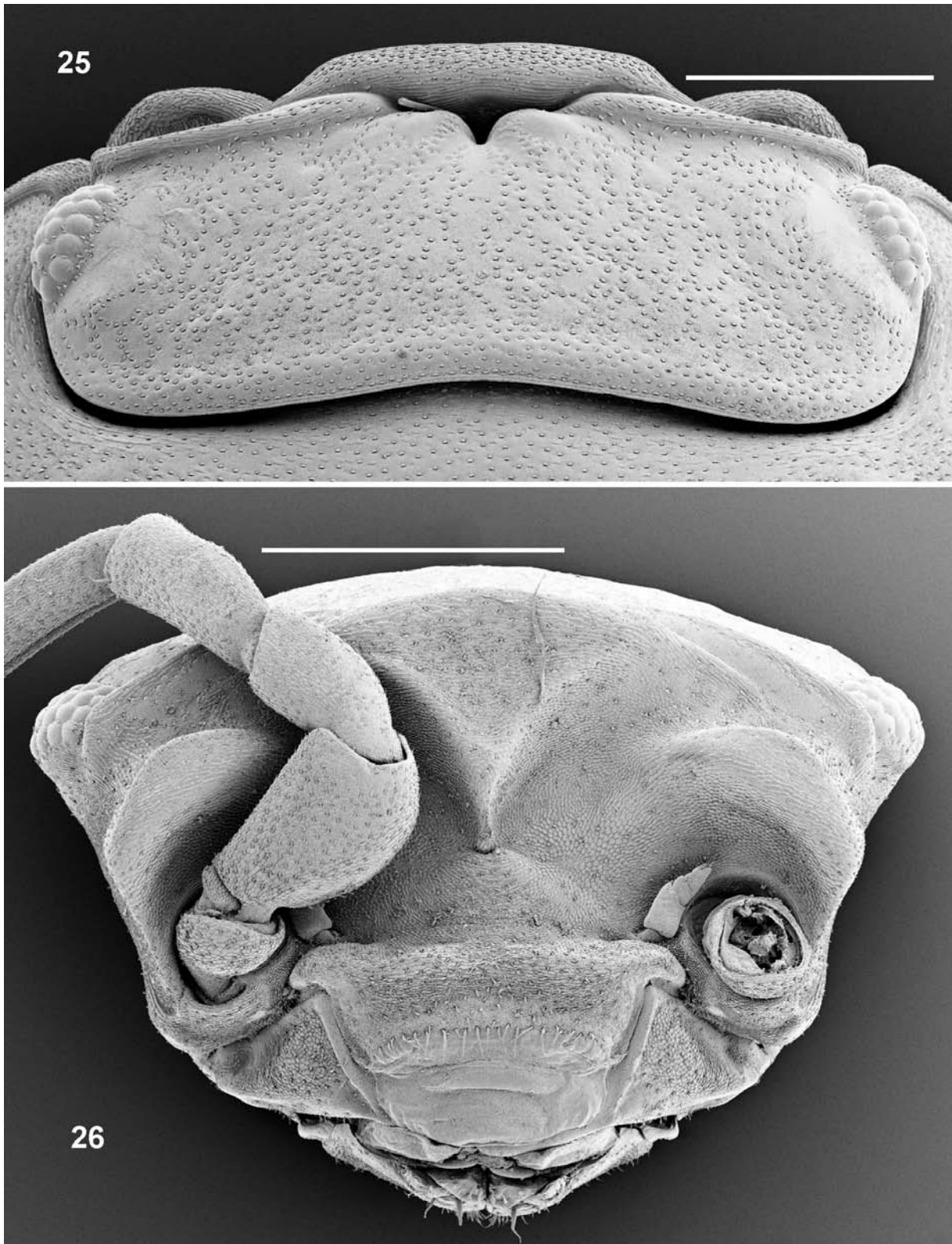

Figs. 25–26. *Armadillidium janinense* (northwestern Greece, Timfi Mountain, SMNS 2751). – 25. ♂, 15.2×7.0mm, head, dorsal view. 26. ♂, 13.3×6.2mm, head, frontal view. – Scales: 1 mm.

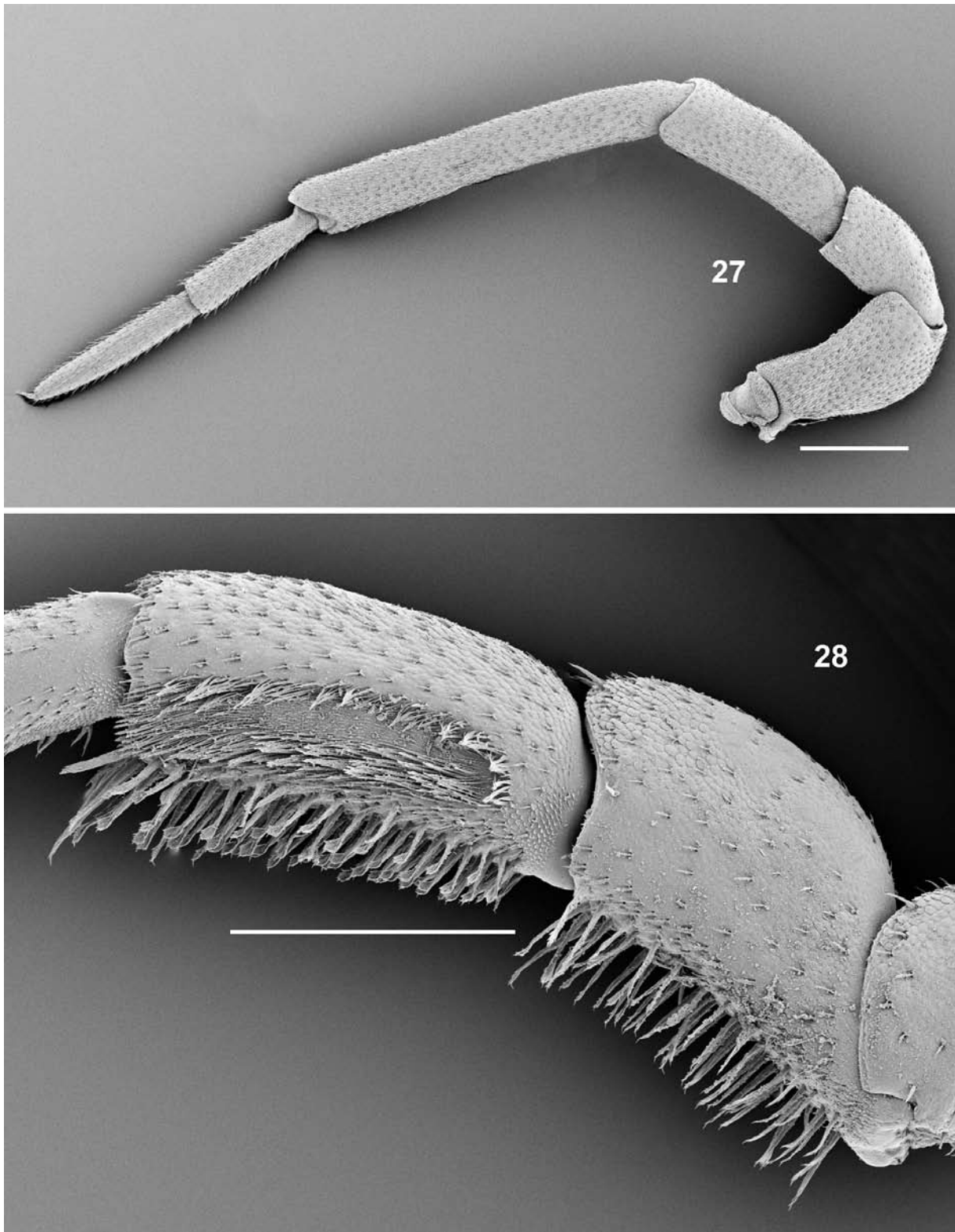

Figs. 27–28. *Armadillidium janinense* (northwestern Greece, Timfi Mountain, SMNS 2751), ♂, 15.2×7.0mm. – 27. Antenna. 28. Pereiopod 1, frontal view. – Scales: 0.5 mm.

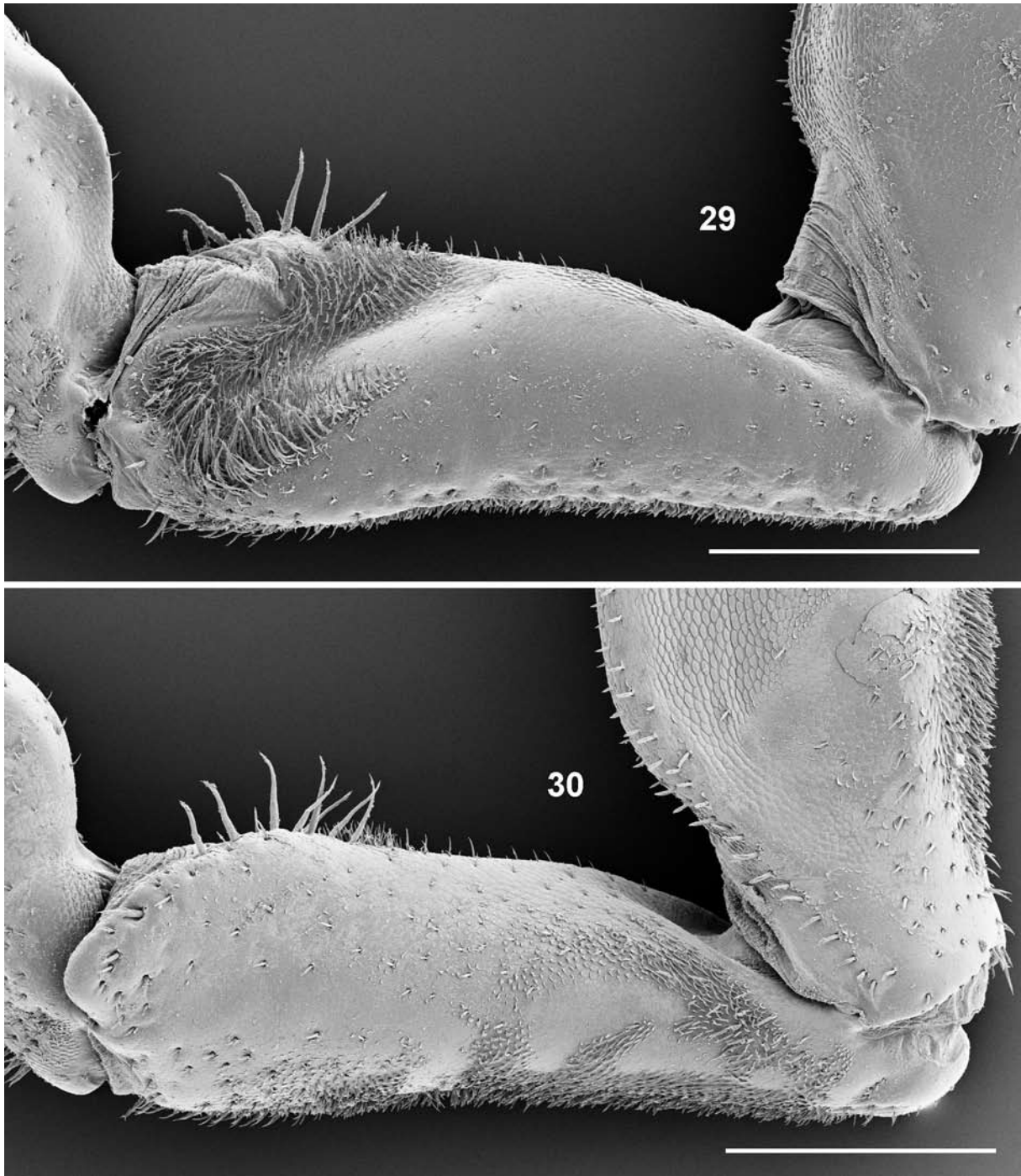

Figs. 29–30. *Armadillidium janinense* (northwestern Greece, Timfi Mountain, SMNS 2751), ♂, 15.2×7.0 mm. – 29. Ischium 7, frontal view. 30. Ischium 7, caudal view. – Scales: 0.5 mm.

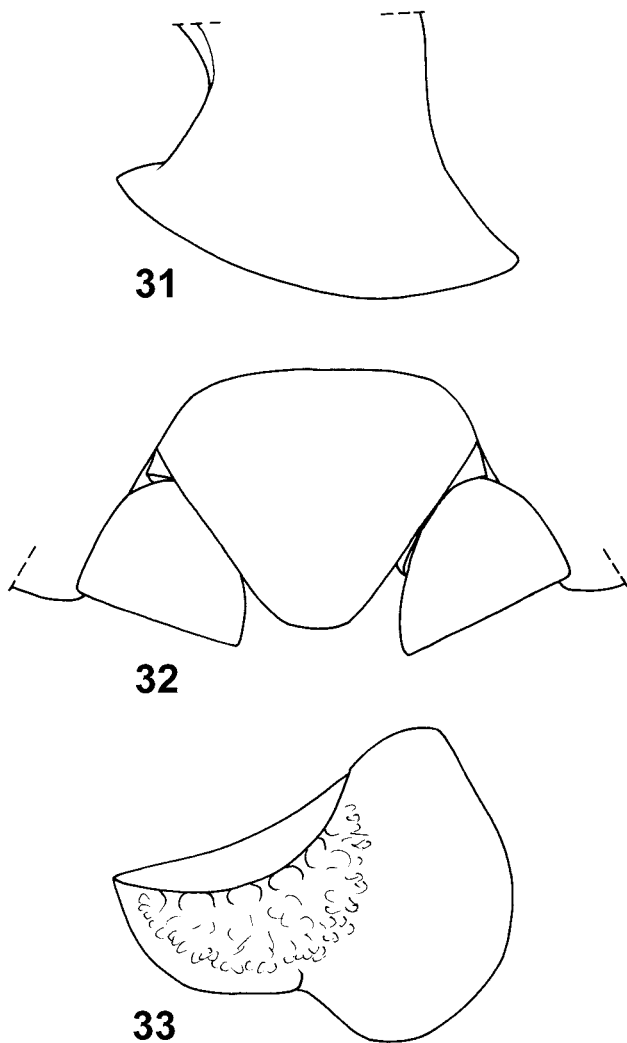

Figs. 31–33. *Armadillidium janinense* (northwestern Greece, Timfi Mountain, SMNS 2411), ♂, 13.0 × 5.8 mm. – **31.** Pereionepimeron 1, lateral view. **32.** Telson and uropods in situ, dorsal view. **33.** Pleopod-exopodite 1, dorsal view.

medial edge slightly concave (Fig. 33), endopodite 1 with apex straight. Uropod-exopodite terminally conspicuously straight-cut with sharp angles (Fig. 32).

Distribution

Known from the western Greek mainland (map Fig. 34), perhaps also occurring in southwestern ex-Yugoslavian Macedonia (see under Remarks).

Remarks

From the illustrations given by FRANKENBERGER (1941: 12) for *A. storkani* n. sp. from the Galičica Mountain in southwestern ex-Yugoslavian Macedonia this species seems to be identical with *A. janinense*. To be sure about

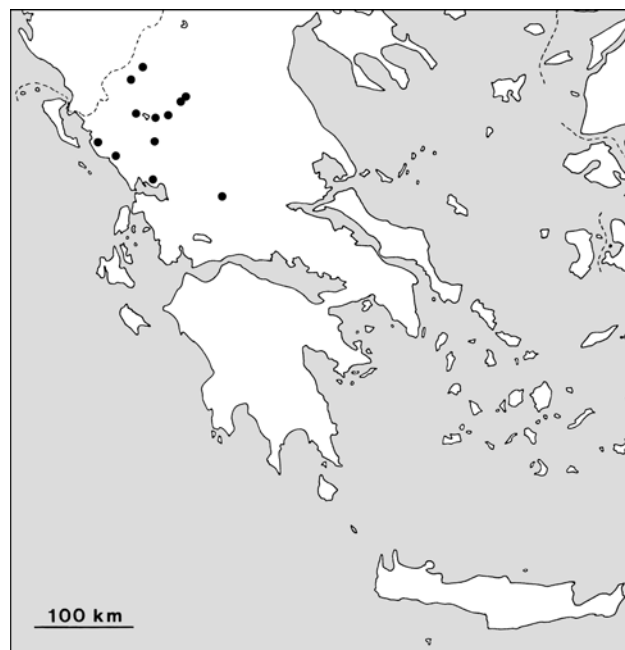

Fig. 34. Known records of *Armadillidium janinense*.

this synonymy the type material of *A. storkani* should be re-investigated, the types are, however, not available.

All diagnostic characters of *A. janinense* show conspicuous similarities with the characters of *A. bensei* Schmalzfuss, 2006 from the Peloponnese (compare SCHMALFUSS 2006a: 18ff.). The characters of the male pereopod 7 are certainly common derived characters (synapomorphies) suggesting the two taxa to be sister species. Another species possessing the same derived hair-field structures is *A. granulatum* Brandt, 1833 (compare SCHMALFUSS 2006a: 29), so the three species possibly form a monophyletic group.

3.6 *Armadillidium jerrentrupii* n. sp.

(Figs. 35–46, map Fig. 47)

Material examined

H o l o t y p e : ♂, 18.5 × 8.5 mm, Greece, northern mainland, prefecture Xánthi, Néstos Gorge N of Toxótes, among boulders on the steep side of the river shore, high maquis vegetation, leg. SCHMALFUSS, 30.IV.1990 (SMNS T597).

P a r a t y p e s : 9 ♂♂, 8 ♀♀, 7 juv., same data as holotype (SMNS 2283). – 32 ex., same locality as holotype, leg. SCHAWALLER & SCHMALFUSS, 25.IV.1994 (SMNS 2435), leg. SCHMALFUSS, 18.X.2005 (SMNS 2864), 11.V.2006 (SMNS 1125). – 22 ex., Greece, northern mainland, prefecture Kavála, Lekáni Mountain, 2 km N of Polínero, mixed forest, leg. SCHMALFUSS, 6.V.1990 (SMNS 2271). – 21 ex., as before, 10 km N of Paleá Kavála, 600 m, maquis and *Castanea* forest, leg. SCHAWALLER & SCHMALFUSS, 20.IV.1994 (SMNS 2430).



Figs. 35–36. *Armadillidium jerrentrupii* n. sp., live animal, photographed by the author in 1990 in the Néstos Gorge near Toxótes (type locality). – 35. Animal walking. 36. Animal rolled-up.

Derivatio nominis

The species is dedicated to HANS JERRENTUP (Avramiliá, prefecture Kavála/Greece), who introduced me to the Néstos Gorge and to other fascinating biotopes in Greece.

Diagnostic characters

Maximum dimensions: 17.0 × 7.3 mm.

Coloration: Dark gray, the specimens from the Néstos Gorge with yellowish epimera and hind margins of tergites, the other samples uniformly gray.

Cuticular structures: Tergites smooth (Fig. 37).

Live animals see Figs. 35–36. Frontal shield from behind surpassing frontal margin of head, upper margin nearly straight, laterally with oblique rounded angles (Fig. 38); antennal lobes semicircular (Fig. 39). Hind margin of pereion-epimeron 1 with pronounced angle (Fig. 44). Telson longer than wide, with nearly straight sides and broadly truncate apex (Fig. 45). Antenna see Fig. 40, segments of the flagellum more or less the same length. Male carpus 1 with brush of short spines (Fig. 41); male ischium 7 ventrally straight, frontally with distal hair-field (Figs. 42–43). Male pleopod-exopodite 1 with short triangular hind-lobe (Fig. 46), endopodite 1 with apex straight. Uropod-exopodite with strongly rounded inner angle (Fig. 45).

Distribution

Northern Greek mainland, lower Néstos river system (map Fig. 47).

Remarks

The new species seems to be a close relative of *A. fossuligerum*, considering the morphology of head, telson and male pleopods, it shows however clear differences indicating a separate species status. The coloration is different, the antenna is much more slender, the male ischium 7 is ventrally straight, not concave as in *A. fossuligerum*, and the uropod-exopodite is longer and has a strongly rounded inner angle. The allopatric distribution is further evidence for a sister group relationship.

3.7 *Armadillidium marmoratum* Strouhal, 1929

This species was treated in the 23rd contribution of this series (SCHMALFUSS 2006a). It is known from the coasts of Greece (Ionian island Lefkáda, Peloponnese, Aegean islands, northern Aegean coast), western Turkey including Black Sea coast, Cyprus, Israel and Egypt. A map of the overall distribution is found in SCHMALFUSS (2000: 79, fig. 4), for safe Greek records see map fig. 153 in SCHMALFUSS (2006a).

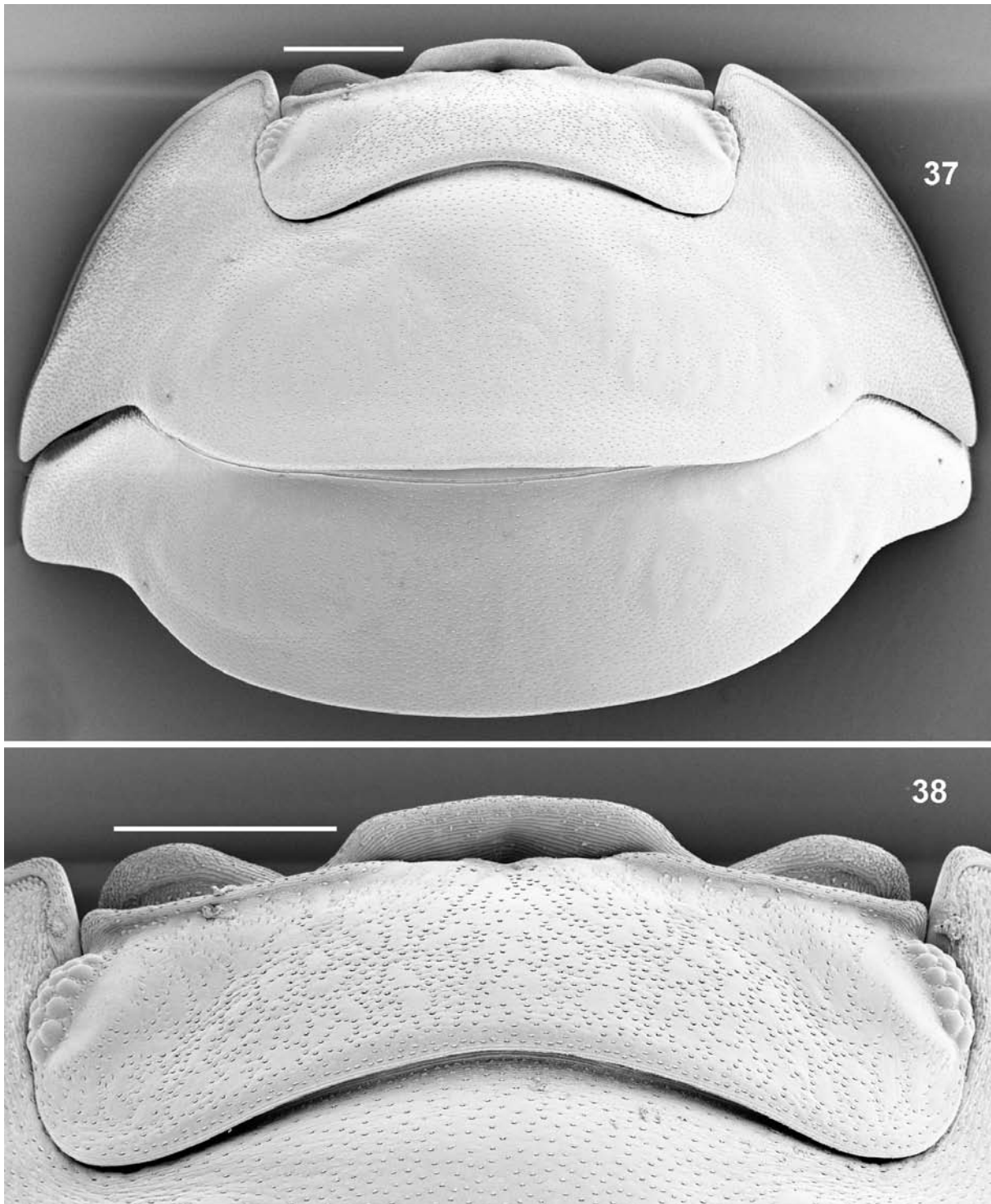

Figs. 37–38. *Armadillidium jerrentrupii* n. sp., ♂, 18.3 × 9.2 mm, paratype from type locality (Néstos Gorge, SMNS 2283). – 37. Head and pereion-tergites 1 and 2, dorsal view. 38. Head, dorsal view. – Scales: 1 mm.

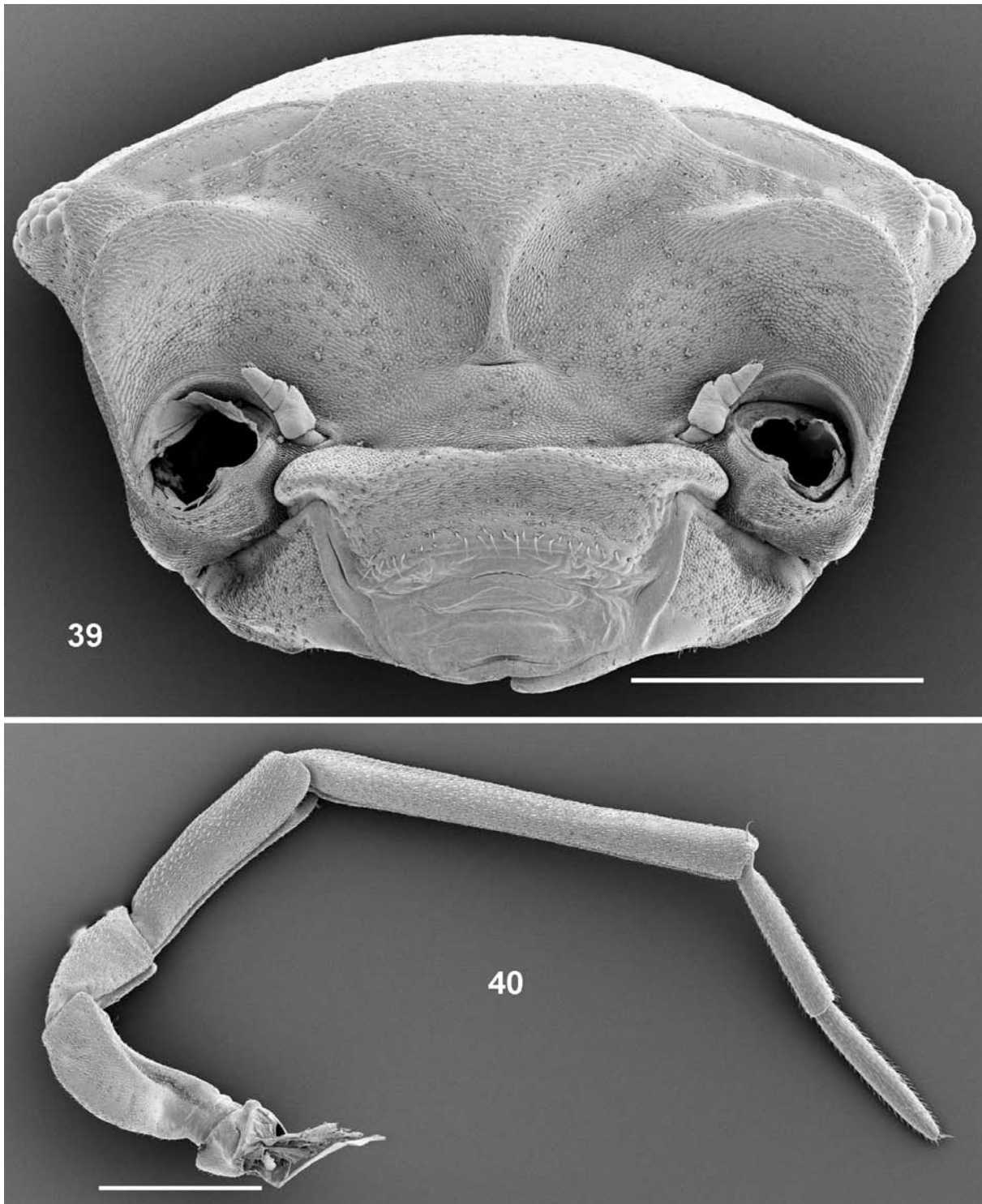

Figs. 39–40. *Armadillidium jerrentrupii* n. sp., paratypes from type locality (Néstor Gorge, SMNS 2283). – 39. ♂, 16.0 × 7.5 mm, head, frontal view. 40. ♂, 18.3 × 9.2 mm, antenna. – Scales: 1 mm.

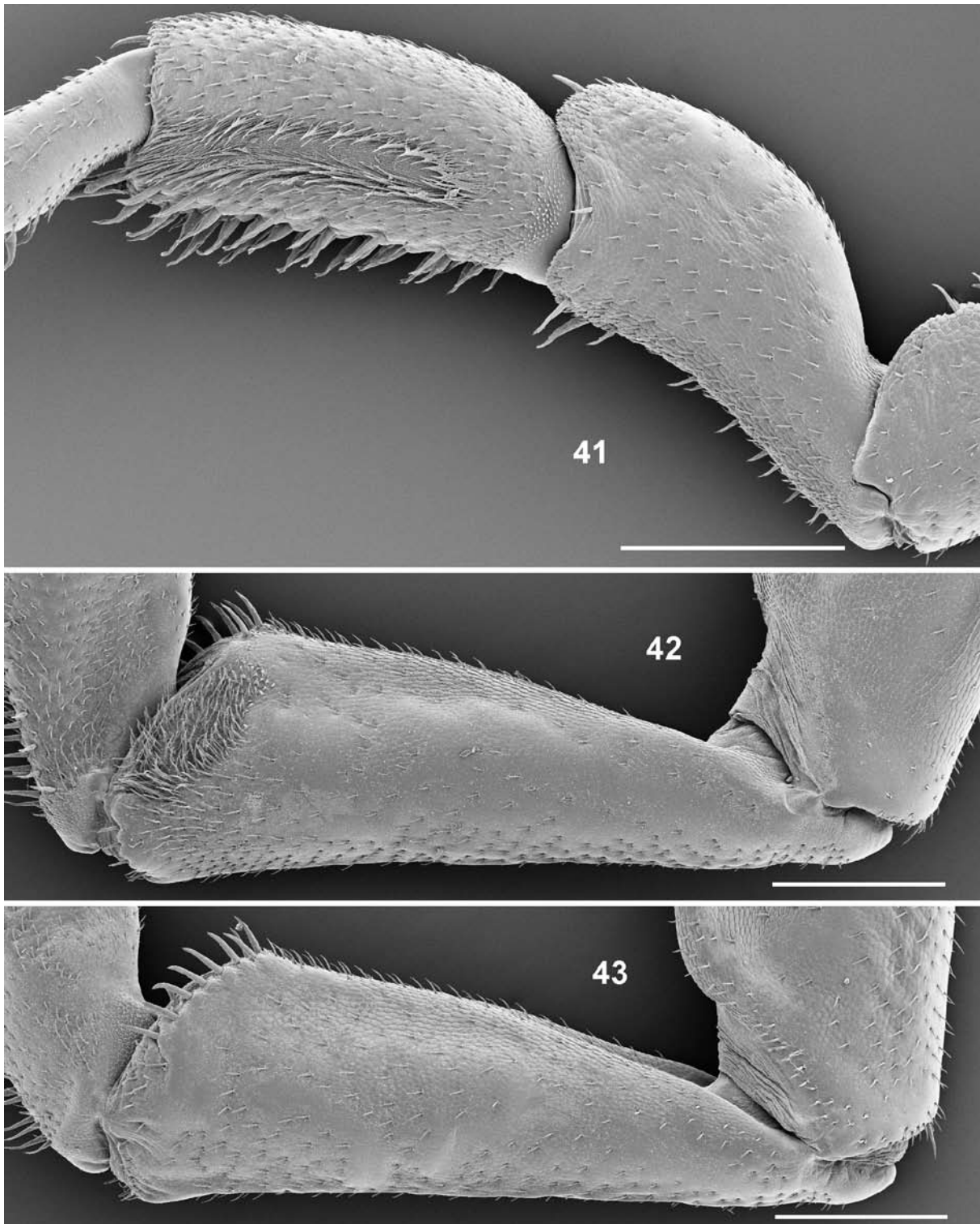

Figs. 41–43. *Armadillidium jerrentrupii* n. sp., ♂, 18.3×9.2mm, paratype from type locality (Néstos Gorge, SMNS 2283). – 41. Pereiopod 1, frontal view. 42. Ischium 7, frontal view. 43. Ischium 7, caudal view. – Scales: 0.5mm.

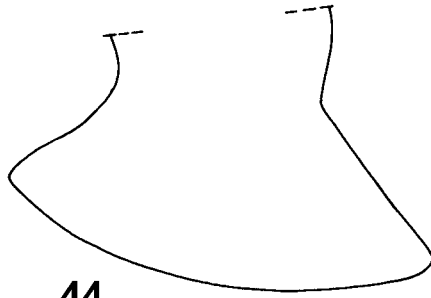

44

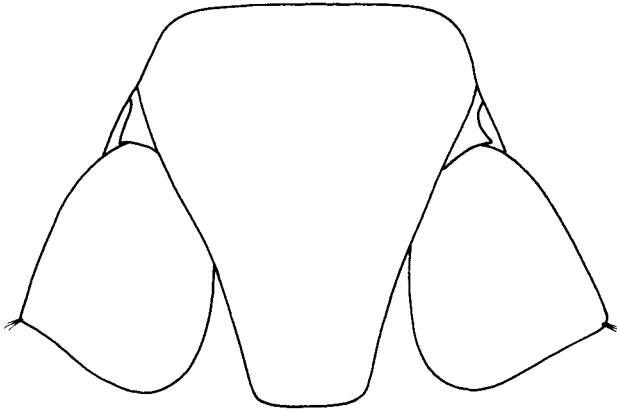

45

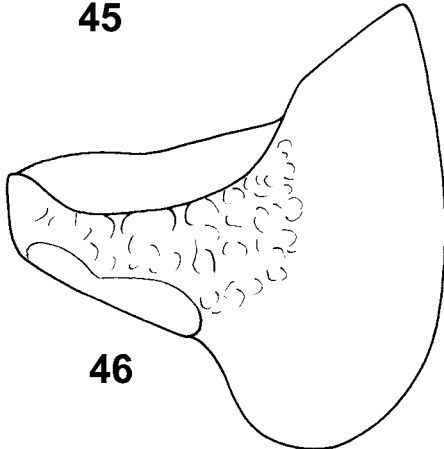

46

Figs. 44–46. *Armadillidium jerrentrupii* n. sp., ♂, 18.3 × 9.2 mm, paratype from type locality (Néstos Gorge, SMNS 2283). – **44.** Pereion-epimeron 1, lateral view. **45.** Telson and uropods in situ, dorsal view. **46.** Pleopod-exopodite 1, dorsal view.

3.8 *Armadillidium pangaionum* n. sp. (Figs. 48–57, map Fig. 88)

Material examined

H o l o t y p e: ♂, 13.5 × 5.8 mm, Greece, northern mainland, prefecture Sérres, Pangéo Mountain, northern side, monastery Ikosifinisi, 500 m, mixed forest, leg. SCHMALFUSS, 4.V.1990 (SMNS T600).

Paratypes: 7 ex., same data as holotype (SMNS 2275). – 5 ex., same locality as holotype, leg. PIEPER, 20.IV.1987 (SMNS 2165). – 1 ex., Pangéo Mountain, northern side, above Próti, 1100 m, *Fagus*, maquis, leg. SCHMALFUSS, 4.V.1990 (SMNS 2274), leg. PIEPER, 11.V.1995 (SMNS 2529). – 12 ex., Pangéo Mountain, 1900 m, above timber line, alpine meadows, leg. SCHMALFUSS, 2.V.1990 (SMNS 2281). – 9 ex., Pangéo Mountain, eastern side, 1500–1600 m, *Fagus*, leg. PIEPER, 19.IV.1987 (SMNS 2159), leg. SCHMALFUSS, 2.V.1990 (SMNS 2279). – 56 ex., Pangéo Mountain, eastern side, 1000–1300 m, leg. MANICASTRI, 4.V.1982 (SMNS 2698), leg. OSELLA, 20.VII.1983 (SMNS 2087), leg. SCHMALFUSS, 1.V.2002 (SMNS 2733). – 26 ex., Pangéo Mountain, eastern side, 650–900 m, *Fagus-Quercus* forest, leg. SCHAWALLER & SCHMALFUSS, 30.IV.1994 (SMNS 2414), leg. SCHMALFUSS, 3.V.1990 (SMNS 2277, 2278). – 10 ex., prefecture Kavála, 5 km W of Eleftherúpoli, 400 m, *Quercus, Platanus*, leg. SCHAWALLER & SCHMALFUSS, 29.IV.1994 (SMNS 2432). – 1 ex., prefecture Sérres, Néa Elvetía, leg. PIEPER, 23.IV.1987 (SMNS 2161).

Derivatio nominis

The species is named after its main distribution area, the Pangéo Mountain in the eastern part of the province Macedonia.

Diagnostic characters

Maximum dimensions: 13.5 × 5.8 mm.

Coloration: Tergites dark gray with small light muscle-spots.

Cuticular structures: Tergites smooth with a very faint rugosity (Fig. 48).

Frontal shield from behind surpassing frontal margin of head, upper margin slightly rounded, with obtuse angles laterally, caudally with conspicuous groove (Fig. 49); antennal lobes semicircular (Fig. 50). Hind margin of pereion-epimeron 1 with pronounced obtuse angle (Fig. 44). Telson slightly longer than wide, with nearly straight sides and rounded apex (Fig. 45). Antenna see Fig. 40, distal segment of the flagellum slightly longer than proximal one. Male carpus 1 with brush of short spines (Fig. 52); male ischium 7 ventrally concave, frontally with distal and ventral hair-fields (Figs. 53–54). Male pleopod-exopodite 1 with hind-lobe elongated to a narrow pointed apex (Fig. 57), endopodite 1 with apex straight.

Distribution

Northern Greece, seems to be restricted to the region of the Pangéo Mountain (map Fig. 88).

Remarks

The species seems to be another member of the *insulanum*-group, which includes the species *insulanum*, *atticum* and *pelionense* (see SCHMALFUSS 2006b: 18, 32). The elongated hind-lobe of the male pleopod-exopodite 1 and a number of other differences (pereion-epimeron 1, telson, male ischium 7) indicate a separation on the species level.

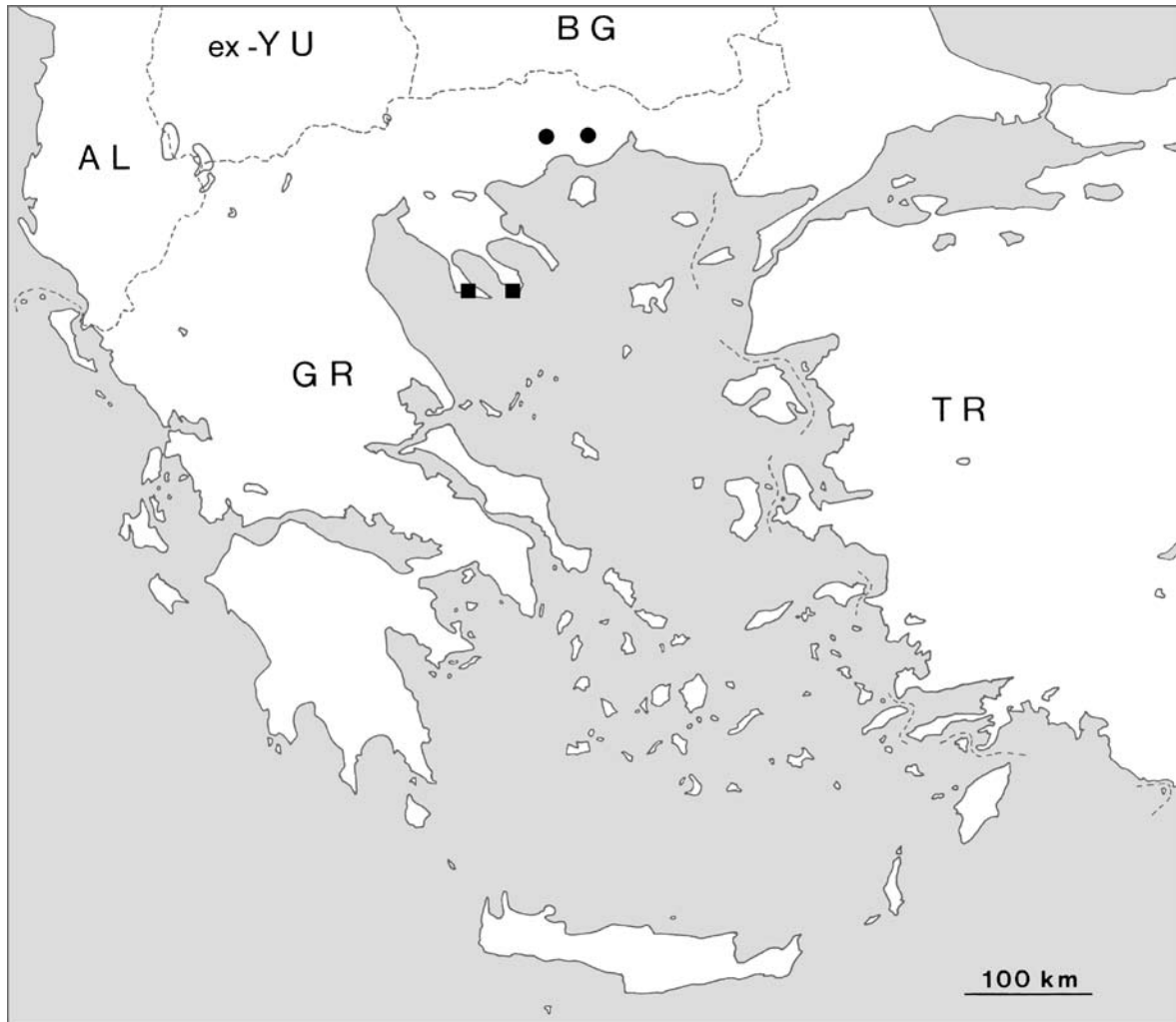
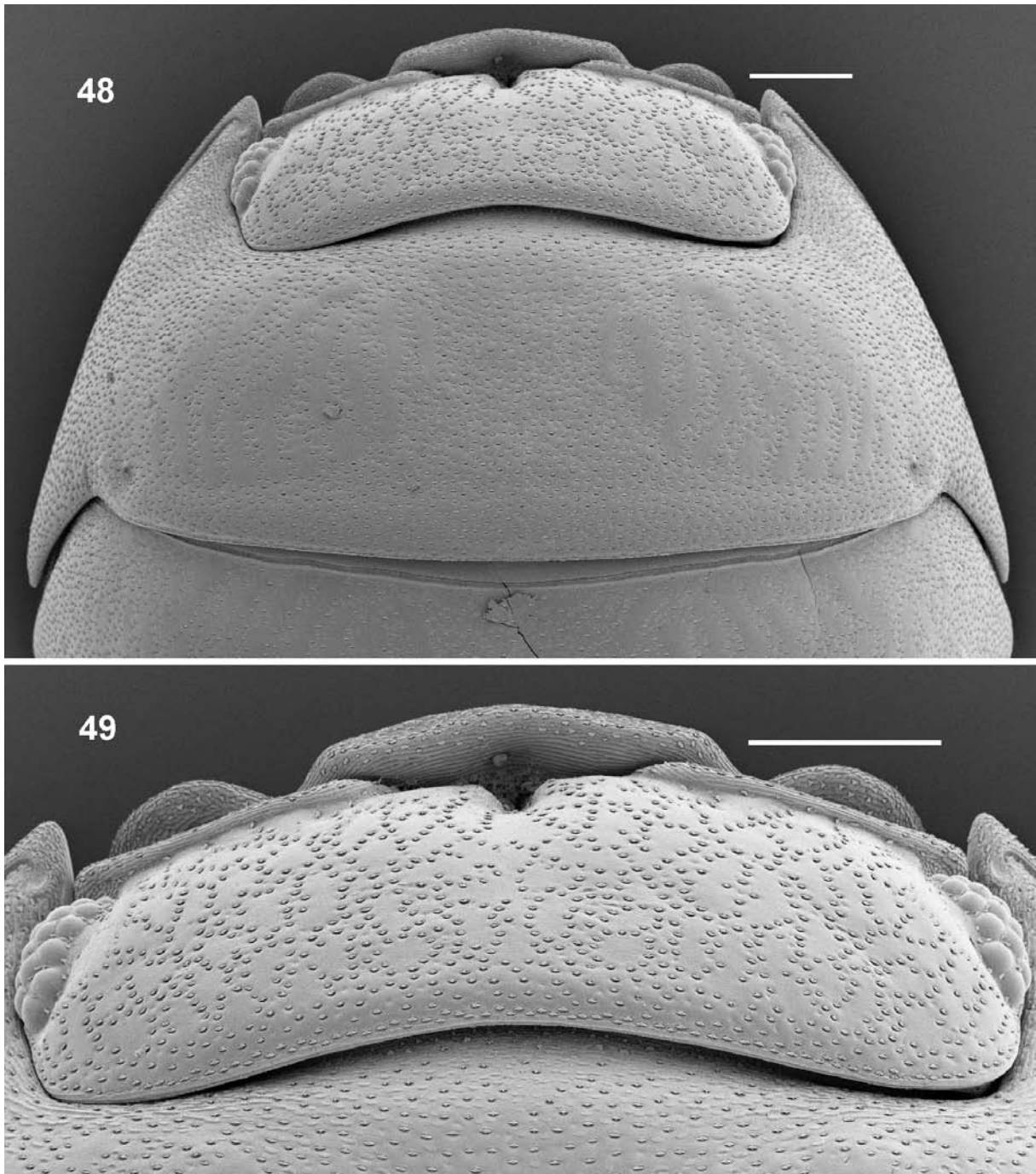
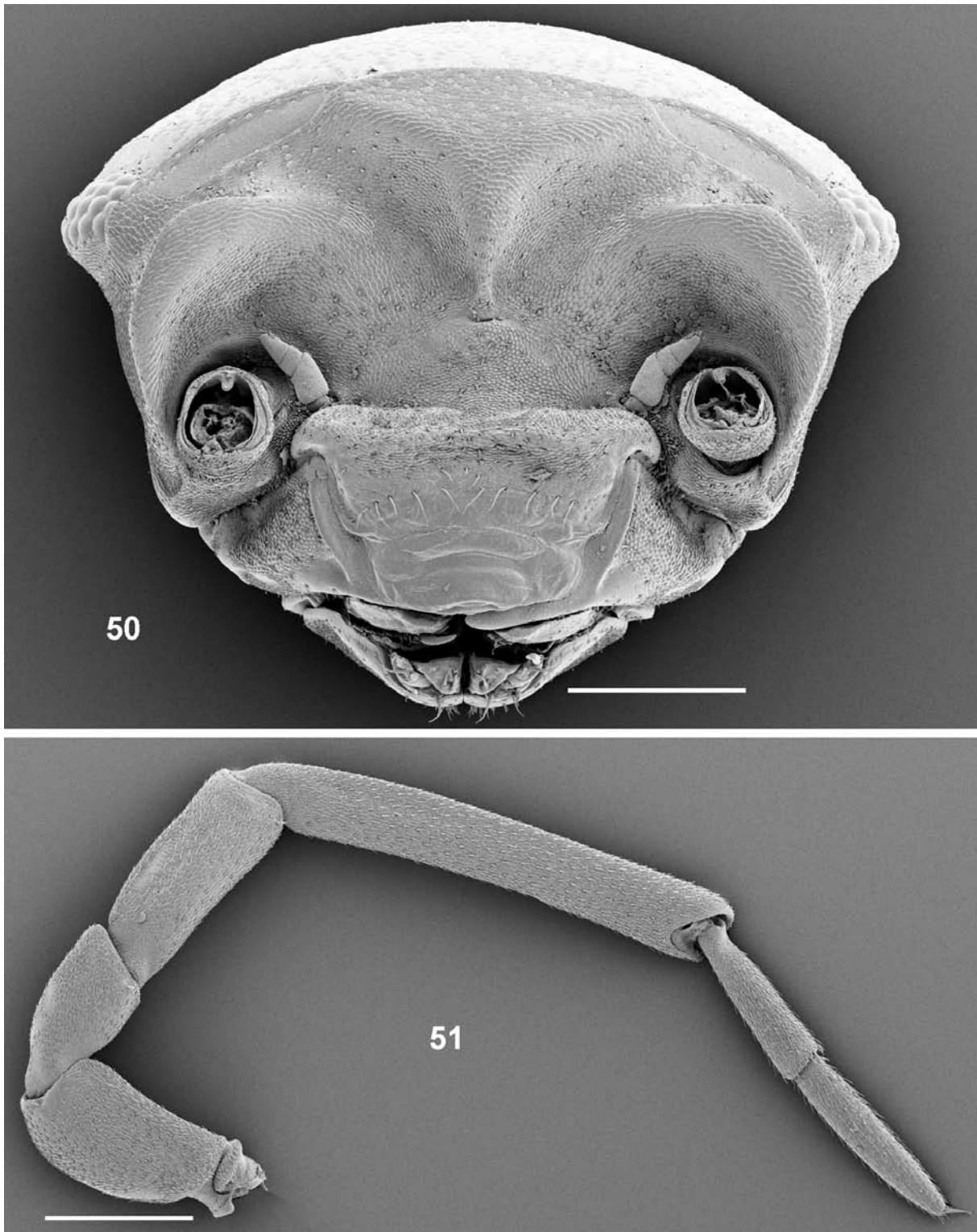

Fig. 47. Known records of *Armadillidium jerrentrupii* n. sp. (●) and *A. pieperi* n. sp. (■).



Figs. 48–49. *Armadillidium pangaionum* n. sp., ♂, 12.0×4.7 mm, paratype from Pangéo Mountain (SMNS 2414). – 48. Head and pereion-tergite 1, dorsal view. 49. Head, dorsal view. – Scales: 0.5 mm.



Figs. 50–51. *Armadillidium pangaionum* n. sp., paratypes from Pangéo Mountain (SMNS 2414). – 50. ♂, 11.2×4.4 mm, head, frontal view. 51. ♂, 12.0×4.7 mm, antenna. – Scales: 0.5 mm.

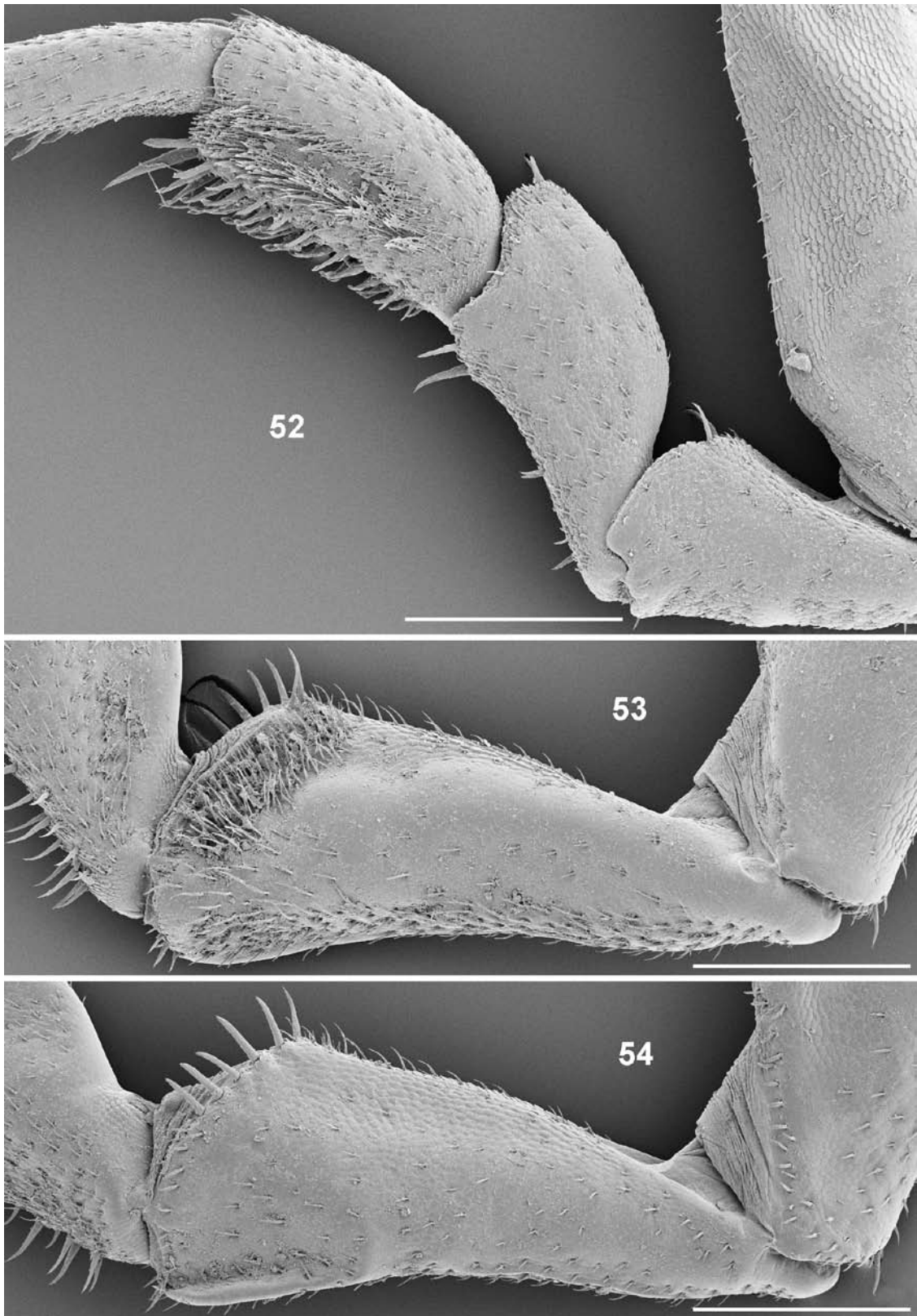

Figs. 52–54. *Armadillidium pangaionum* n. sp., ♂, 12.0×4.7 mm, paratype from Pangéo Mountain (SMNS 2414). – 52. Pereiopod 1, frontal view. 53. Ischium 7, frontal view. 54. Ischium 7, caudal view. – Scales: 0.4 mm.

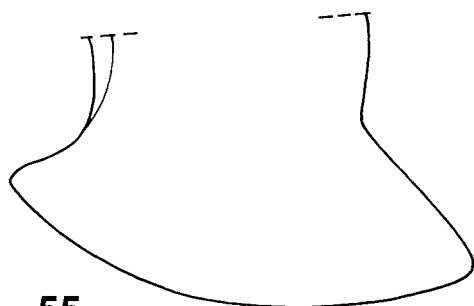

55

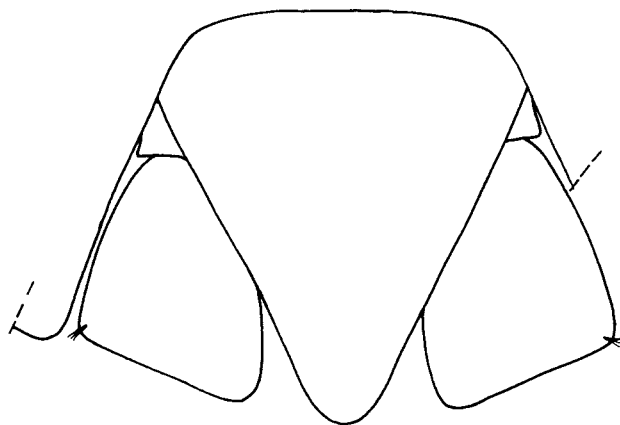

56

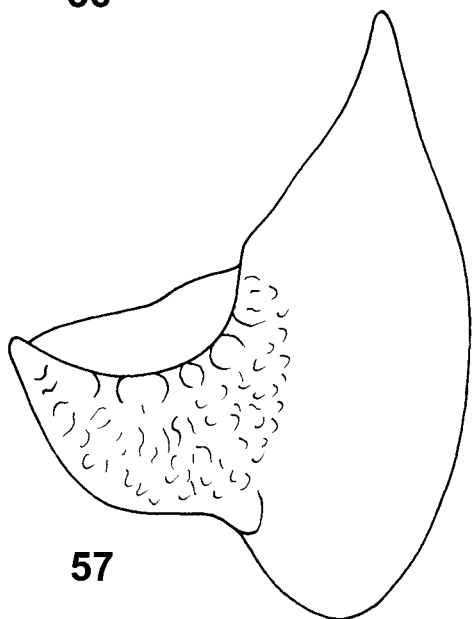

57

Figs. 55–57. *Armadillidium pangaionum* n. sp., ♂, 13.5 × 5.8 mm, holotype (SMNS T600). – 55. Pereion-epimeron 1, lateral view. 56. Telson and uropods in situ, dorsal view. 57. Pleopod-exopodite 1, dorsal view.

3.9 *Armadillidium petralonense* n. sp.

(Figs. 58–67, map Fig. 68)

Material examined

H o l o t y p e : ♂, 15.0 × 7.2 mm, northern Greece, prefecture Khalkidiki, Petralona, leg. MARTENS, 15.III.1963 (SMNS T601).

P a r a t y p e s : 2 ex., same data as holotype (SMNS 1500). – 7 ex., northern Greece, prefecture Thessaloniki, Thessaloniki, “Arsakli”, leg. KÜHNELT, III.1960 (SMNS 1685). – 7 ex., prefecture Khalkidiki, Galátista, leg. PIEPER, 28.IX.1995 (SMNS 2534).

Derivatio nominis

The species' name refers to the locus typicus Petralona (northern Greece, prefecture Khalkidiki).

Diagnostic characters

Maximum dimensions: 15 × 7 mm.

Coloration: Tergites gray with small yellowish muscle-spots, epimera yellowish gray.

Cuticular structures: Tergites smooth with a very faint rugosity (Fig. 58).

Frontal shield from behind surpassing frontal margin of head, upper margin completely rounded, no angles laterally, caudally with conspicuous groove (Fig. 59); antennal lobes semicircular (Fig. 60). Hind margin of pereion-epimeron 1 with obtuse angle (Fig. 65). Telson slightly longer than wide, with nearly straight sides and broadly rounded apex (Fig. 66). Antenna see Fig. 61, distal segment of the flagellum slightly longer than proximal one. Male carpus 1 with brush of short spines (Fig. 62); male ischium 7 ventrally straight, frontally with distal hair-field (Figs. 63–64). Male pleopod-exopodite 1 with triangular hind-lobe (Fig. 67), endopodite 1 with apex straight.

Distribution

Northern Greece, Khalkidiki and region east of Thessaloniki (map Fig. 68).

Remarks

The species is very similar to *A. pieperi* n. sp., the differences in the shape of the male ischium 7 (ventrally strongly concave in *petralonense*, straight in *pieperi*) suggest, however, that we have to treat the two forms as separate species. The two species seem to belong to the *fossuligerum*-complex including *fossuligerum* and *jerrentrupii*, differing from the latter species of this group by the shape of the telson (pointed instead of truncate).

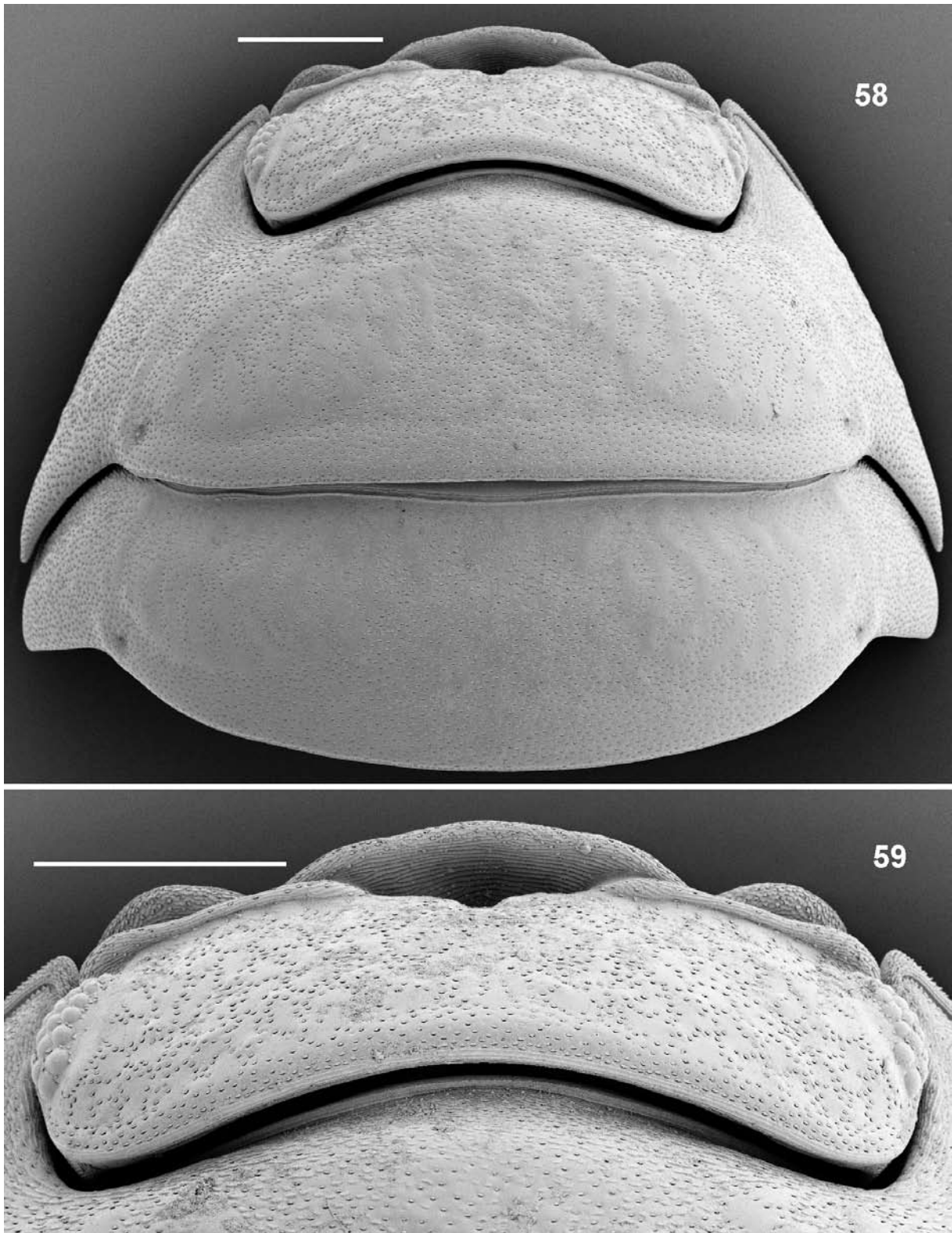

Figs. 58–59. *Armadillidium petralonense* n. sp., ♂, 15.2×7.0 mm, paratype from type locality (Petrálona, SMNS 1500). – 58. Head and pereion-tergite 1, dorsal view. 59. Head, dorsal view. – Scales: 1 mm.

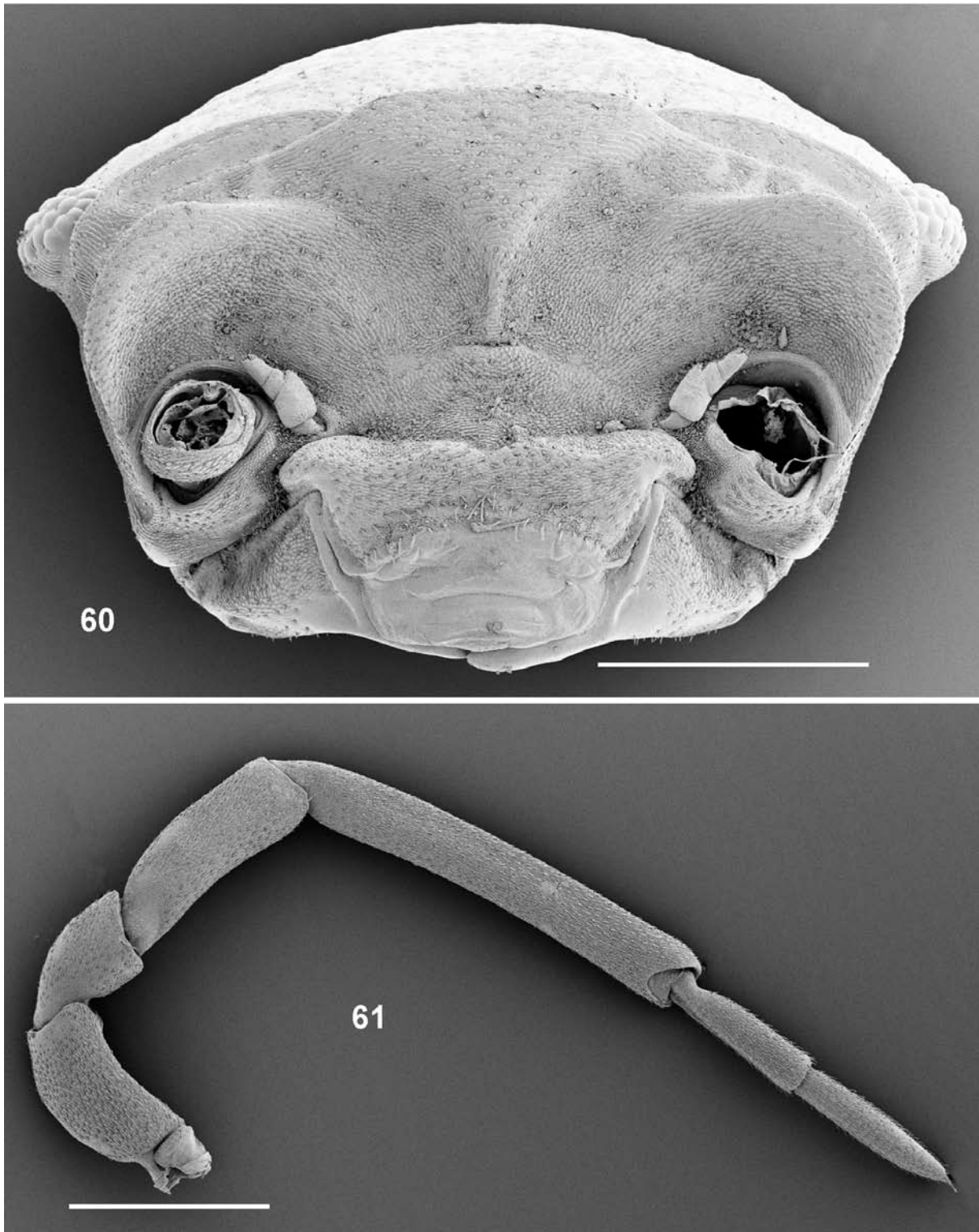

Figs. 60–61. *Armadillidium petralonense* n. sp., ♂, 15.2×7.0 mm, paratypes from type locality (Petráloná, SMNS 1500). – **60.** ♂, 14.0×6.7 mm, head, frontal view. **61.** ♂, 15.2×7.0 mm, antenna. – Scales: 1 mm.

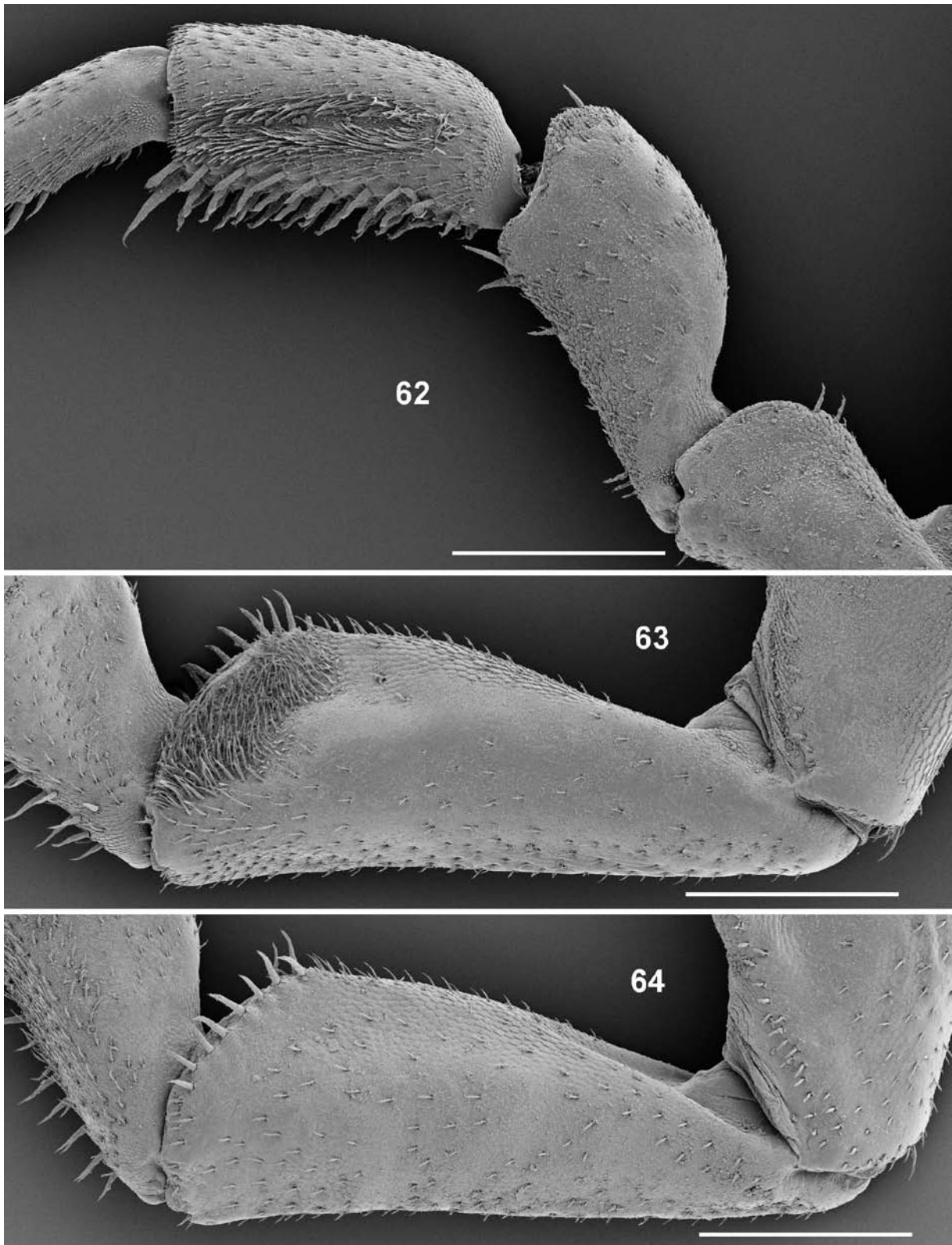

Figs. 62–64. *Armadillidium petralonense* n. sp., ♂, 15.2 × 7.0 mm, paratype from type locality (Petrálon, SMNS 1500). – **62.** Pereopod 1, frontal view. **63.** Ischium 7, frontal view. **64.** Ischium 7, caudal view. – Scales: 0.5 mm.

3.10 *Armadillidium phalacronum* n.sp.

(Figs. 69–79, map Fig. 68)

Material examined

Holotype: ♂, 11×5 mm, Greece, northern mainland, prefecture Dráma, Falakró Mountain, western flank, 1300 m, *Fagus, Pinus*, leg. SCHMALFUSS, 30.IV.1990 (SMNS T598).

Paratypes: 28 ex., same data as holotype (SMNS 2426). – 2 ex., same locality as holotype, 1100 m, leg. PIEPER, 21.IX.1995 (SMNS 2530). – 41 ex., same locality as holotype, 800 m, maquis, leg. SCHMALFUSS, 5.V.2002 (SMNS 2736). – 45 ex., Falakró Mountain, Khionótripa, 1700–1800 m, alpine meadows above timber line, leg. SCHAWALLER & SCHMALFUSS, 19.IV.1994 (SMNS 2437), leg. PIEPER, 21.IX.1995 (SMNS 2535). – 17 ex., Falakró Mountain, eastern flank, 8 km N of Livaderó, 650 m, deciduous forest, leg. SCHMALFUSS, 28.IV.1994 (SMNS 2434). – 1 ex., as before, 2 km S of Livaderó, leg. PIEPER, 22.IV.1987 (SMNS 2157). – 28 ex., Falakró Mountain, southern flank, 400 m, maquis, leg. SCHAWALLER & SCHMALFUSS, 28.IV.1994 (SMNS 2422). – 7 ex., prefecture Dráma, Rodópi Mountains, 5 km W of Elatiá, 1600 m, *Fagus-Pinus* forest, leg. SCHMALFUSS, 28.IV.1994 (SMNS 2436).

Derivatio nominis

The species' name refers to its distribution area, which is the Falakró Mountain and its immediate neighborhood to the north.

Diagnostic characters

Maximum dimensions: 12.5×5.5 mm.

Coloration: Brownish gray, sometimes light spots at bases of epimera.

Cuticular structures: Tergites nearly completely smooth (Fig. 69).

Frontal shield from behind surpassing frontal margin of head, upper margin nearly straight, obtuse angles laterally, caudally with conspicuous groove (Fig. 70); antennal lobes semicircular (Figs. 71–72). Hind margin of pereion-epimeron 1 with obtuse angle (Fig. 77). Telson wider than long, with straight sides and rounded apex (Fig. 78). Antenna see Fig. 73, distal segment of the flagellum somewhat longer than proximal one. Male carpus 1 with faintly developed brush of short spines (Fig. 74); male ischium 7 ventrally slightly concave, frontally with distal hair-field (Figs. 75–76). Male pleopod-exopodite 1 with triangular hind-lobe (Fig. 79), endopodite 1 with apex straight.

Distribution

Northern Greece, Falakró Mountain and southern slope of western Rodópi Mountains (map Fig. 66).

Remarks

The species is very close to *A. insulanum*. Because of slight morphological differences (*phalacronum*: rounded instead of straight upper margin of frontal triangle, rounded instead of trapezoidal antennal lobes, male pleopod-exopodite 1 with a conspicuously longer hind-lobe) I consider *A. phalacronum* a different taxon on the species level,

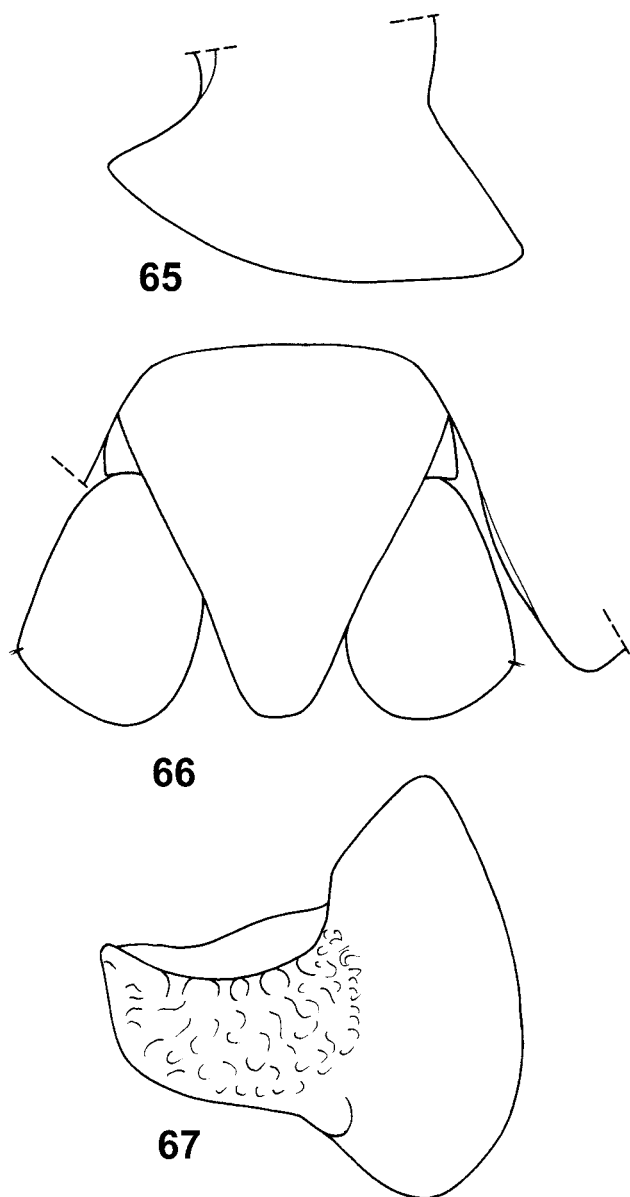

Figs. 65–67. *Armadillidium petralonense* n. sp., ♂, 15.3×7.2 mm, holotype (SMNS T601). – **65.** Pereion-epimeron 1, lateral view. **66.** Telson and uropods in situ, dorsal view. **67.** Pleopod-exopodite 1, dorsal view. – Scales: 0.5 mm.

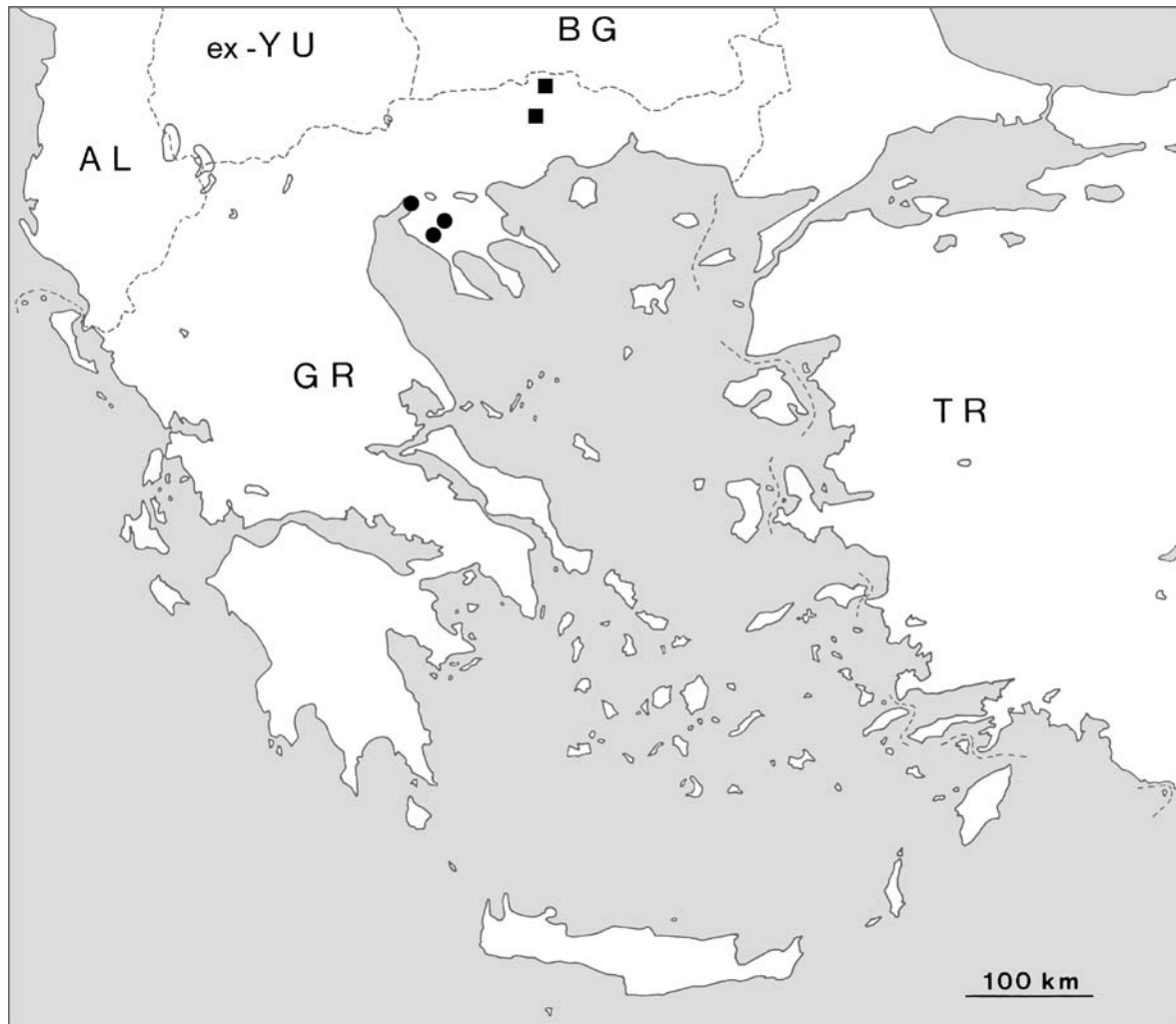
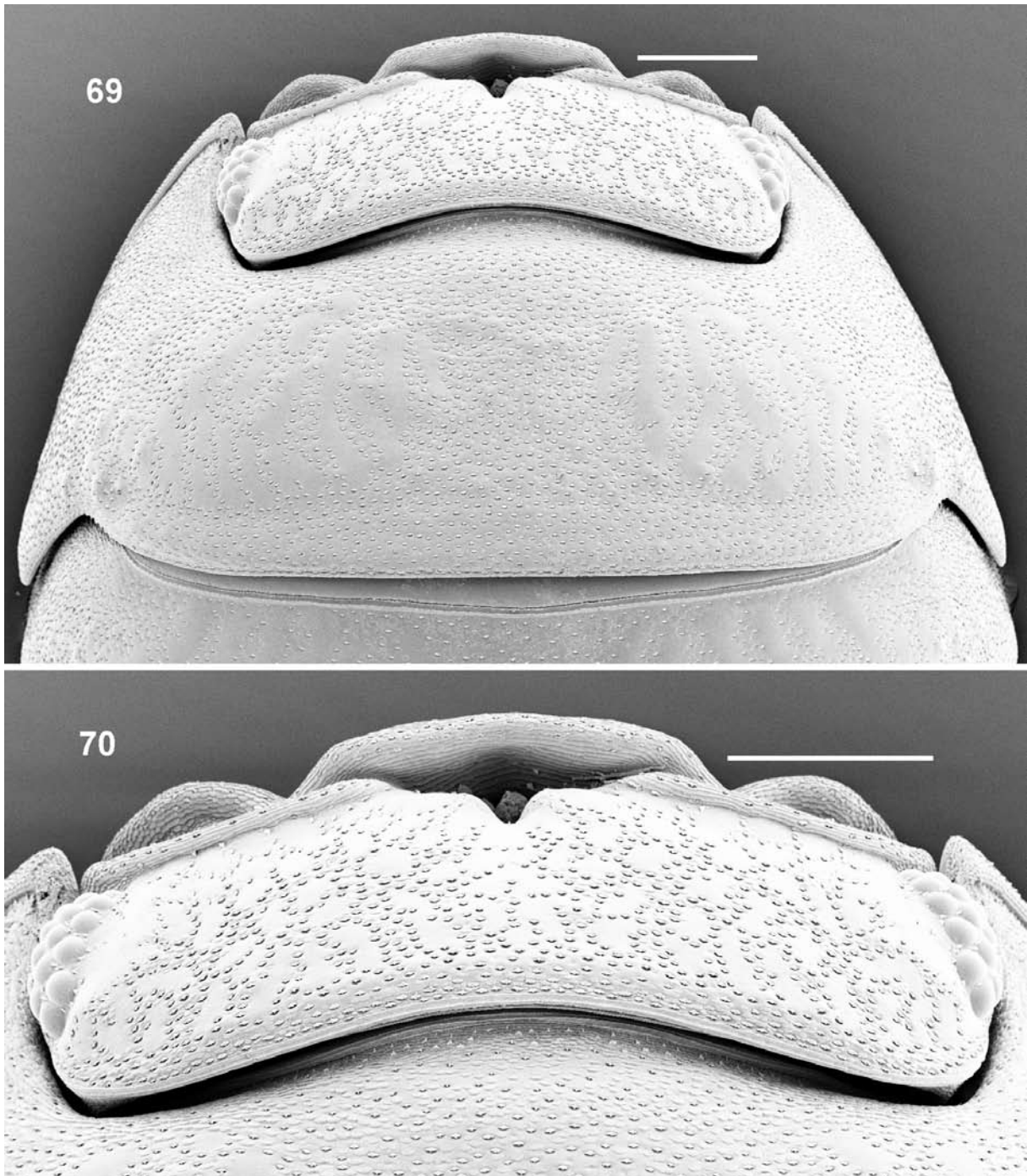
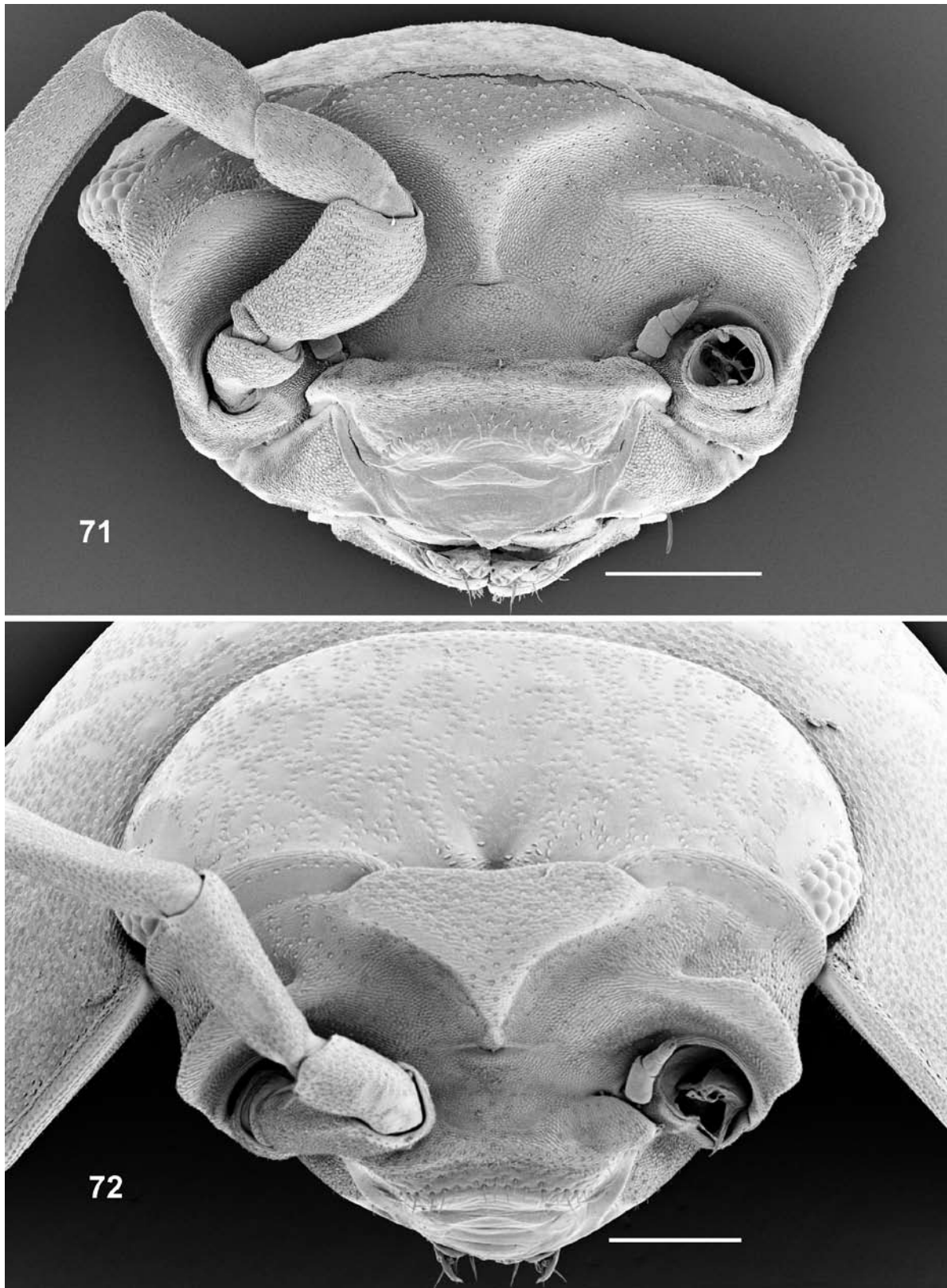

Fig. 68. Known records of *Armadillidium petralonense* n. sp. (●) and *A. phalacronum* n. sp. (■).



Figs. 69–70. *Armadillidium phalacronum* n. sp., ♂, 10.5 × 4.7 mm, paratype from type locality (Falakró Mountain, SMNS 2426). – 69. Head and pereion-tergite 1, dorsal view. 70. Head, dorsal view. – Scales: 0.5 mm.



Figs. 71–72. *Armadillidium phalacronum* n.sp., paratypes from type locality (Falakró Mountain, SMNS 2426). – 71. ♀, 11.2×5.2 mm, head, frontal view. 72. ♂, 13.0×5.5 mm, head, oblique frontal view. – Scales: 0.5 mm.

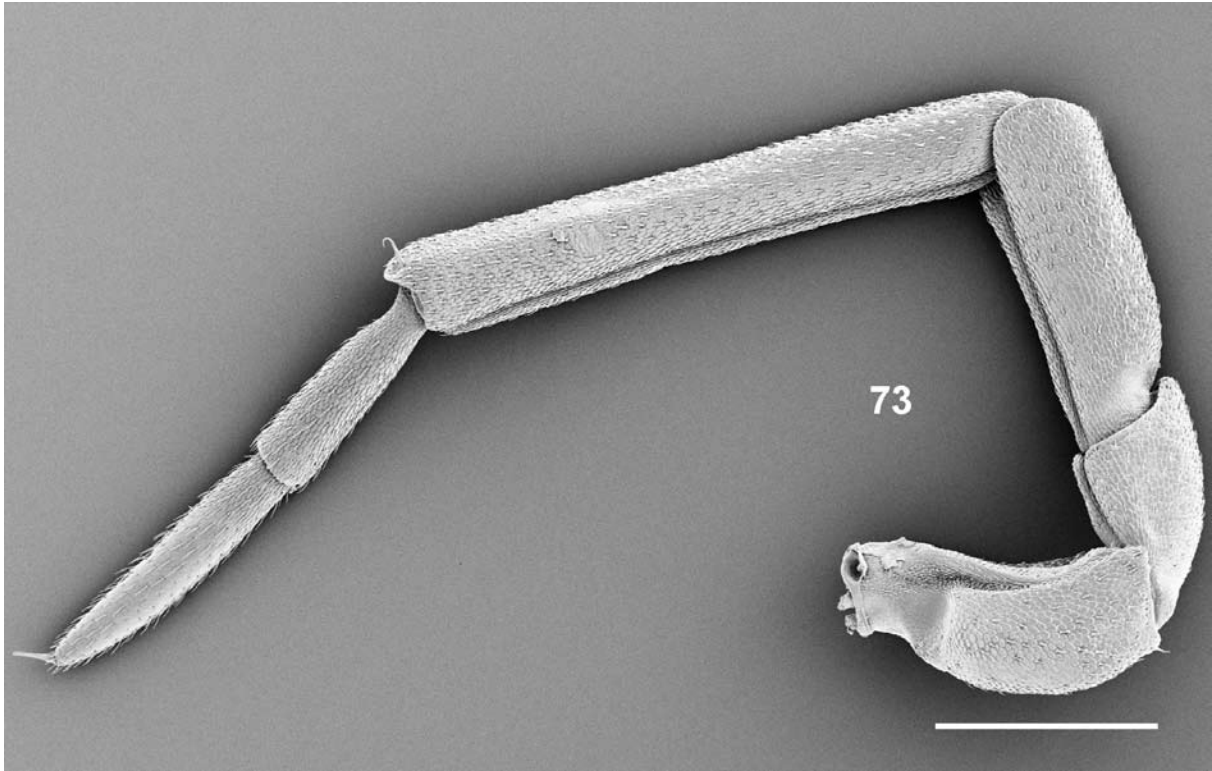
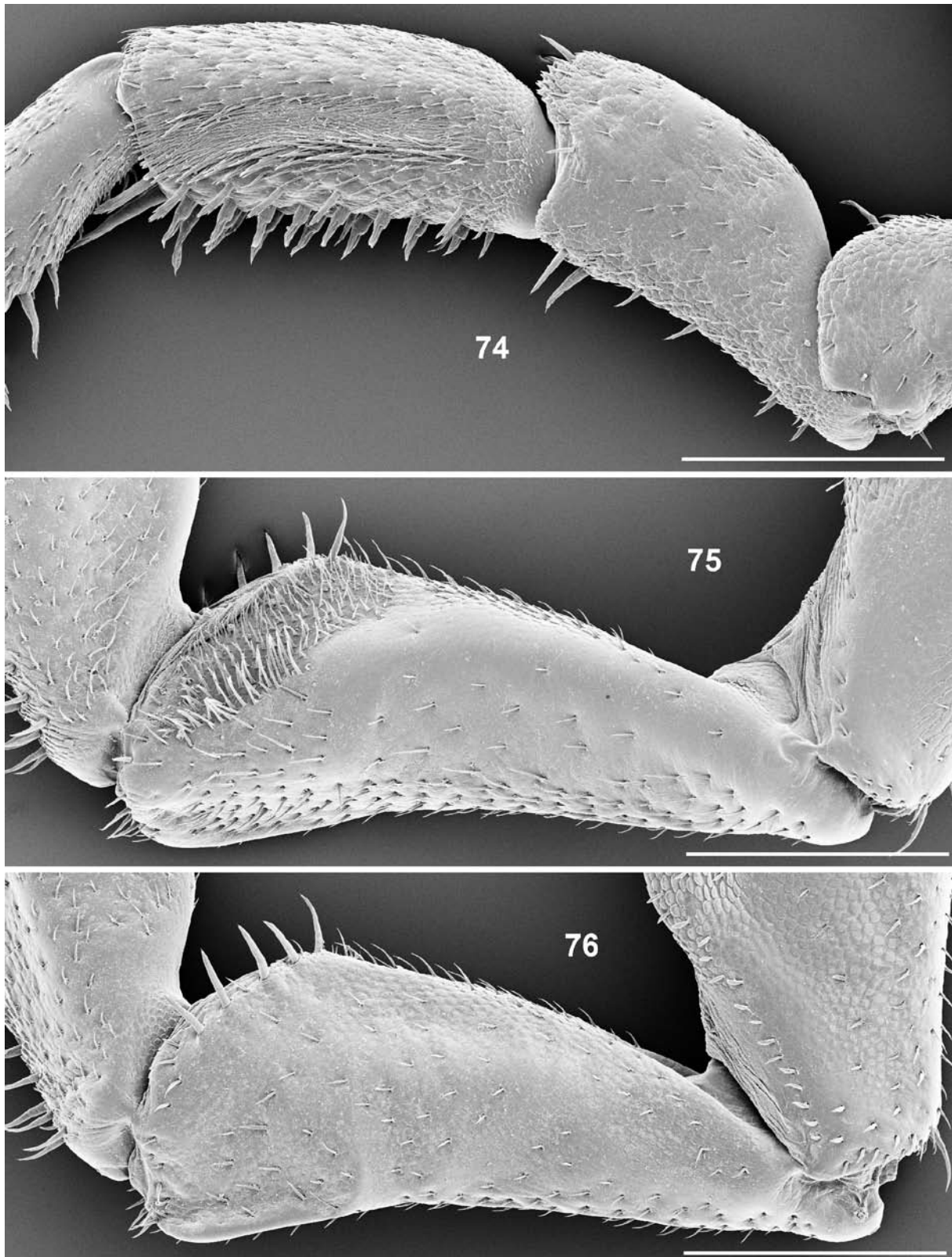

Fig. 73. *Armadillidium phalacronum* n. sp., ♂, 10.5 × 4.7 mm, paratype from type locality (Falakró Mountain, SMNS 2426), antenna.
– Scale: 0.5 mm.



Figs. 74–76. *Armadillidium phalacronum* n. sp., ♂, 10.5×4.7 mm, paratype from type locality (Falakró Mountain, SMNS 2426). – 74. Pereiopod I, frontal view. 75. Ischium 7, frontal view. 76. Ischium 7, caudal view. – Scales: 0.4 mm.

further investigations including molecular data should clarify this questionable point.

3.11 *Armadillidium pieperi* n. sp.
(Figs. 80–87, map Fig. 47)

Material examined

H o l o t y p e : ♂, 12.2 × 5.5 mm, Greece, northern mainland, prefecture Khalkidiki, peninsula Sithonia, 1 km S of Pórtó Kufós, leg. PIEPER, 26.IX.1995 (SMNS T603).

P a r a t y p e s : 2 ex., same data as holotype (SMNS 2531). – 3 ex., as before, peninsula Kassándra, 12 km W of Paliúri, leg. R. GRIMM, 30.VII.1980 (SMNS 1900).

Derivatio nominis

The species is named after Dr. HARALD PIEPER (Kiel/Germany), whose extensive isopod collections have considerably enlarged our knowledge on the distribution of these animals in Greece.

Diagnostic characters

Maximum dimensions: 17.0 × 6.7 mm.

Coloration: Tergites grayish brown, epimera lighter.

Cuticular structures: Tergites faintly tuberculated (Fig. 80).

Frontal shield from behind surpassing frontal margin of head, upper margin completely rounded, no angles laterally, caudally with conspicuous groove (Fig. 80); antennal lobes trapezoidal (Fig. 81). Hind margin of pereion-epimeron 1 with obtuse angle (Fig. 85). Telson as wide as long, with nearly straight sides and rounded apex (Fig. 86). Antenna see Fig. 82, distal segment of the flagellum slightly longer than proximal one. Male carpus 1 with very few short spines (Fig. 83); male ischium 7 ventrally concave, frontally with distal hair-field (Fig. 84). Male pleopod-exopodite 1 with triangular hind-lobe (Fig. 87), endopodite 1 with apex straight.

Distribution

Northern Greece, Khalkidiki, peninsulas Kassándra and Sithonia (map Fig. 47).

Remarks

The species is very close to the allopatric *A. petralonense*, conspicuous differences in the morphology of the male ischium 7 (see under *petralonense*) plead, however, for a separate species status.

3.12 *Armadillidium sfenthourakisi* n. sp.
(Figs. 89–97, map Fig. 88)

Material examined

H o l o t y p e : ♂, 18.0 × 7.8 mm, Greece, north-central mainland, prefecture Piería, E of Ólimpos Mountain, Litókhoro, leg. KÜHNELT, 1.V.1960 (SMNS T605).

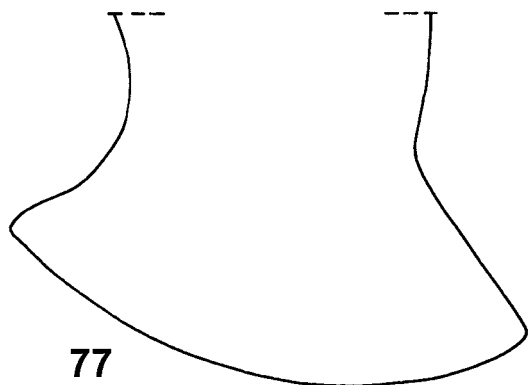

77

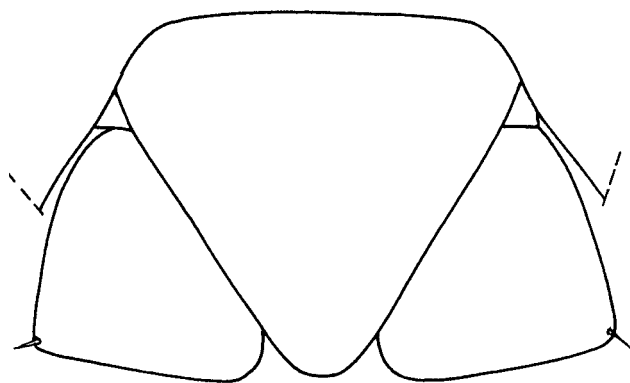

78

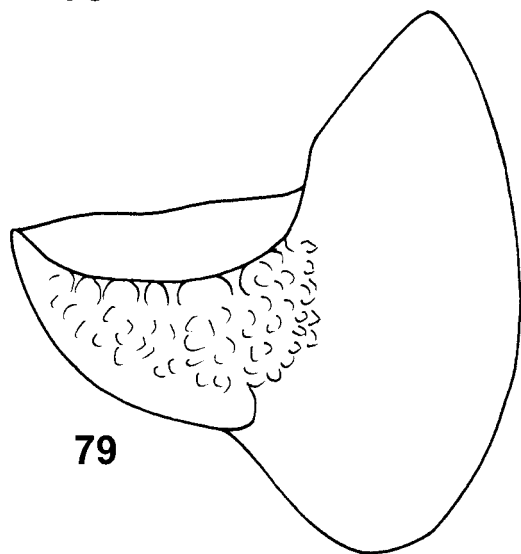

79

Figs. 77–79. *Armadillidium phalacronum* n. sp., ♂, 10.5 × 4.7 mm, paratype from type locality (Falakró Mountain, SMNS 2426). – 77. Pereion-epimeron 1, lateral view. 78. Telson and uropods in situ, dorsal view. 79. Pleopod-exopodite 1, dorsal view.

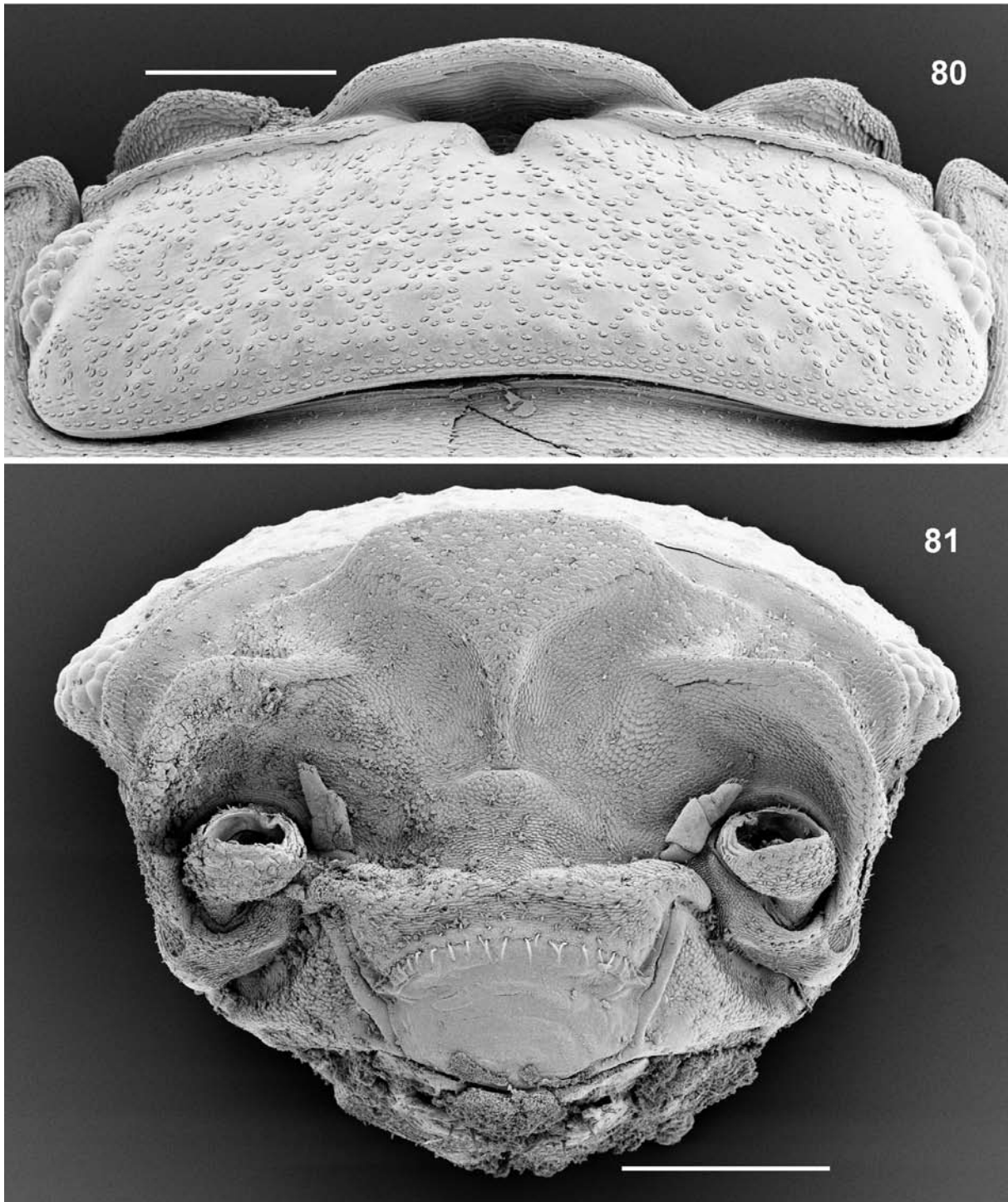

Figs. 80–81. *Armadillidium pieperi* n. sp., paratype from peninsula Kassándra (SMNS 1900). – **80.** ♀, 11.2×5.0 mm, head, dorsal view. **81.** ♂, 9.5×4.2 mm, head, frontal view. – Scales: 0.5 mm.

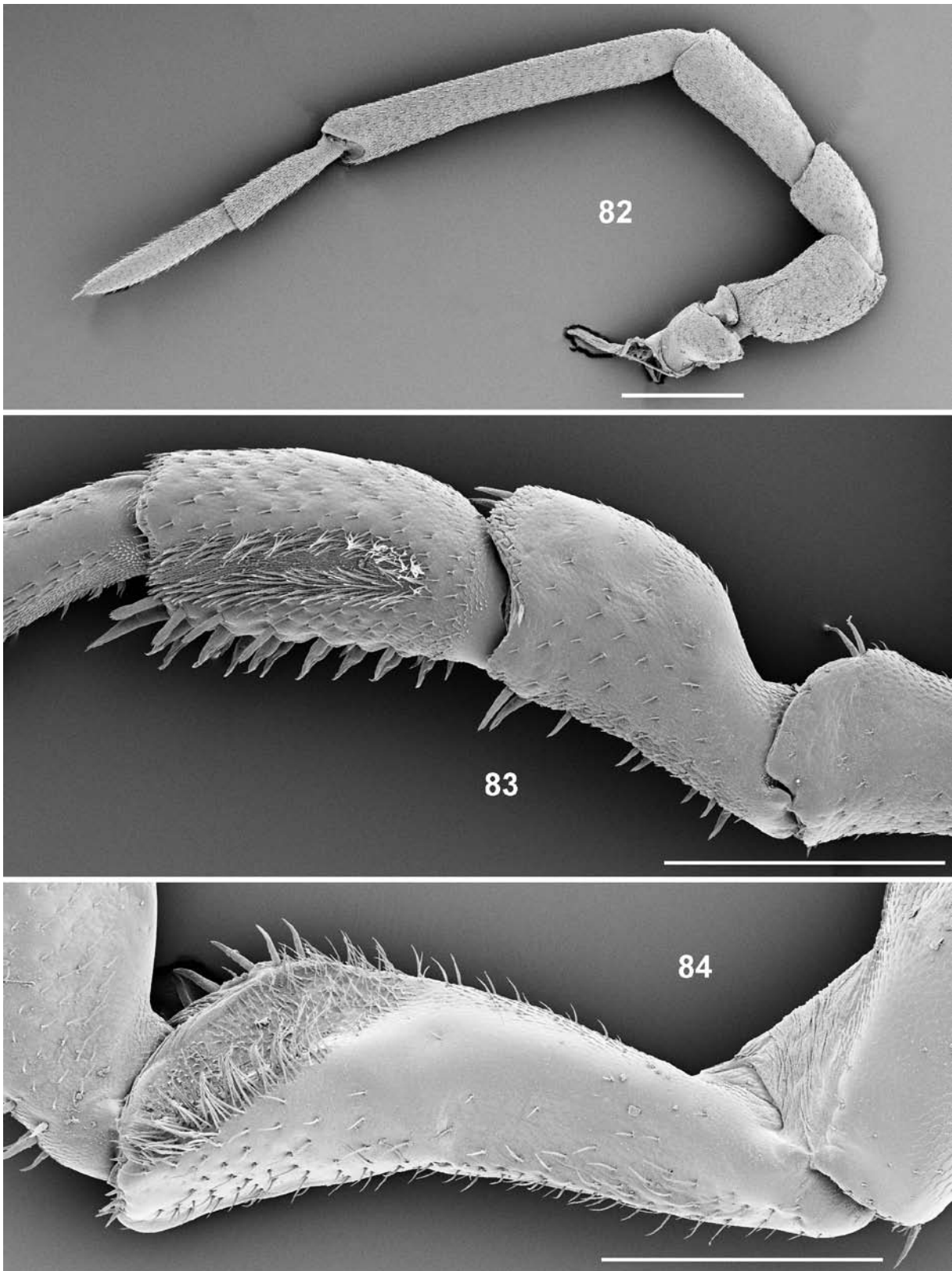

Figs. 82–84. *Armadillidium pieperi* n. sp. – **82.** Paratype from peninsula Kassándra (SMNS 1900), 11.2 × 5.0 mm, antenna. **83.** ♂, 12.2 × 5.5 mm, holotype (SMNS T603), pereopod 1, frontal view. **84.** As before, ischium 7, frontal view. – Scales: 0.5 mm.

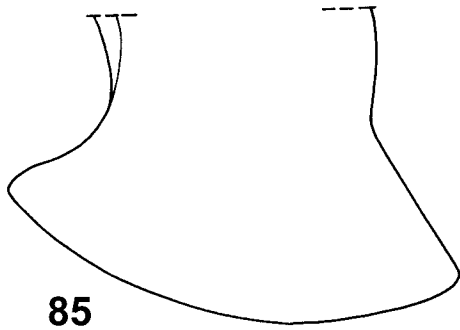

85

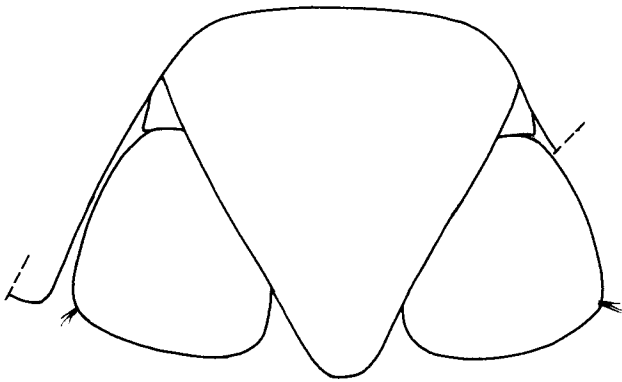

86

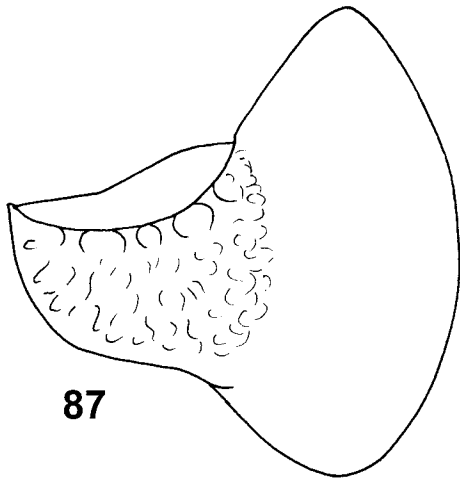

87

Figs. 85–87. *Armadillidium pieperi* n. sp., ♂, 12.2 × 5.5 mm, holotype (SMNS T603). – **85.** Pereion-epimeron 1, lateral view. **86.** Telson and uropods in situ, dorsal view. **87.** Pleopod-exopodite 1, dorsal view.

Paratypes: 4 ex., same data as holotype (SMNS 1701). – 6 ex., prefecture Pieria, 20 km S of Katerini, Dio, leg. SCHÖNFELD, 13.VII.2001 (SMNS 2716). – 10 ex., prefecture Pieria, eastern foot of Ólimpos Mountain, maquis, 500 m, leg. SFENTHOURAKIS, 2.VIII.1990 (SMNS 2772). – 2 ex., prefecture Pieria, eastern foot of Ólimpos Mountain, 1500 m, leg. SFENTHOURAKIS, 3.VIII.1990 (SMNS 2308). – 2 ex., prefecture Pieria, Ólimpos Mountain, “Stavros”, leg. KÜHNELT, 2.V.1960 (SMNS 1680). – 8 ex., prefecture Pieria, northern foot of Ólimpos Mountain, SW of Fotiná, mixed forest, leg. SCHMALFUSS, 7.VI.1976 (SMNS 1725). – 1 ex., central Greek mainland, prefecture Lárissa, E of Kariá, mixed forest, leg. SCHMALFUSS, 2.VI.1976 (SMNS 1799).

Derivatio nominis

Named after Dr. SPYROS SFENTHOURAKIS (Pátra/Greece), whose detailed investigations led to a first comprehensive overview of the terrestrial isopod fauna of the central Aegean islands and to the discovery of a considerable number of island endemisms.

Diagnostic characters

Maximum dimensions: 17.0 × 6.7 mm.

Coloration: Adult specimens blackish gray, smaller specimens lighter and brownish.

Cuticular structures: Tergites granulated (Fig. 89).

Frontal shield from behind surpassing frontal margin of head, upper margin straight, obtuse angles laterally (Fig. 89); antennal lobes triangular (Fig. 90). Hind margin of pereion-epimeron 1 with obtuse angle (Fig. 95). Telson conspicuously longer than wide, with straight sides and broadly rounded apex (Fig. 96). Antenna very slender, segments of the flagellum more or less the same length (Fig. 91). Male carpus 1 with brush of short spines (Fig. 92); male ischium 7 ventrally straight, frontally with distal hair-field (Figs. 93–94). Male pleopod-exopodite 1 with triangular pointed hind-lobe (Fig. 97), endopodite 1 with apex straight.

Distribution

North-central Greek mainland, seems to be restricted to the Ólimpos Mountain massive (map Fig. 88).

Remarks

This species does not exhibit any clear affinities to other species of the region. Perhaps the next relatives are the species of the *jonicum*-group (*jonicum* and *epiroticum*) from the western part of Greece, but it is only the shape of the telson that points in this direction.

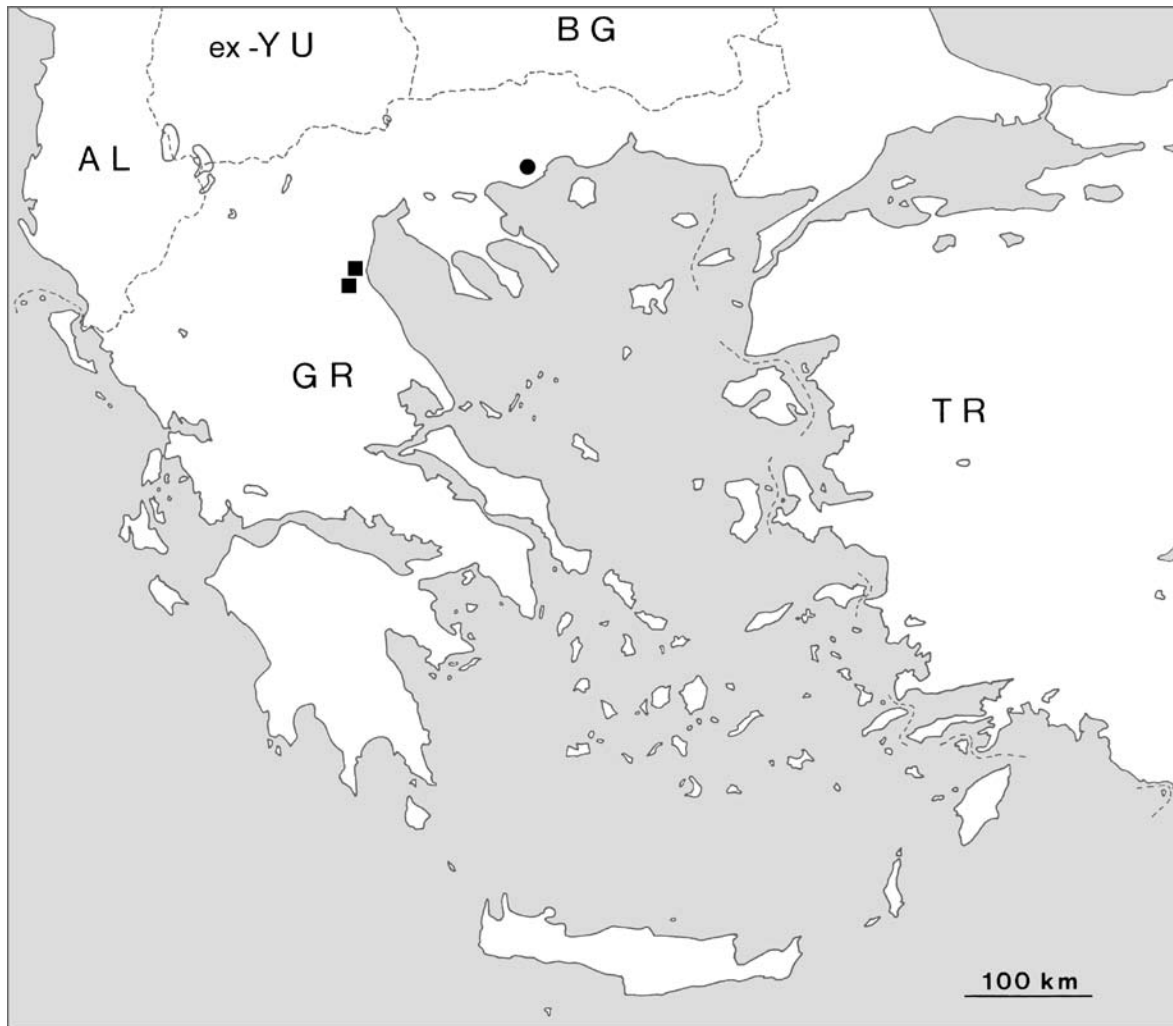
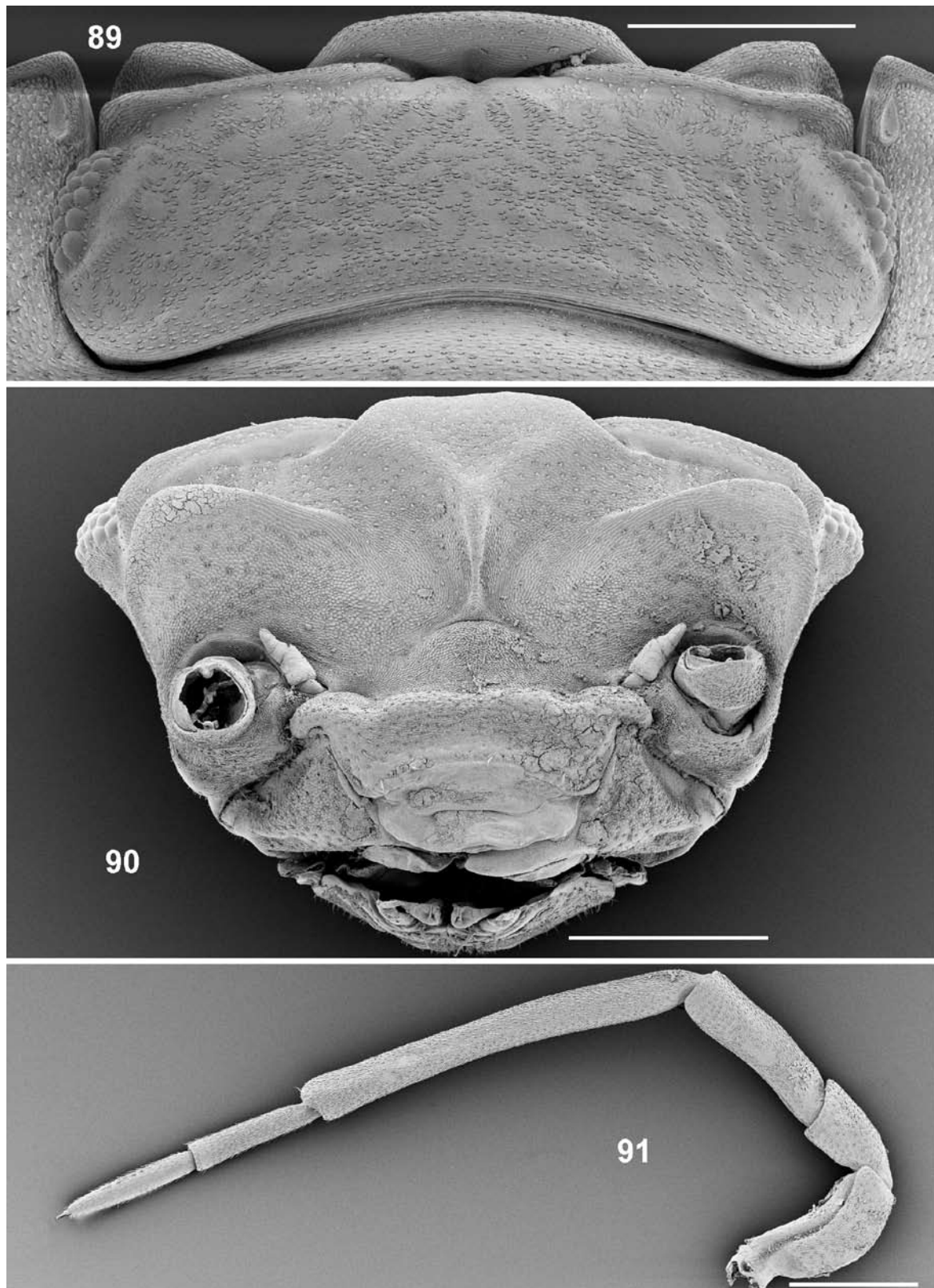
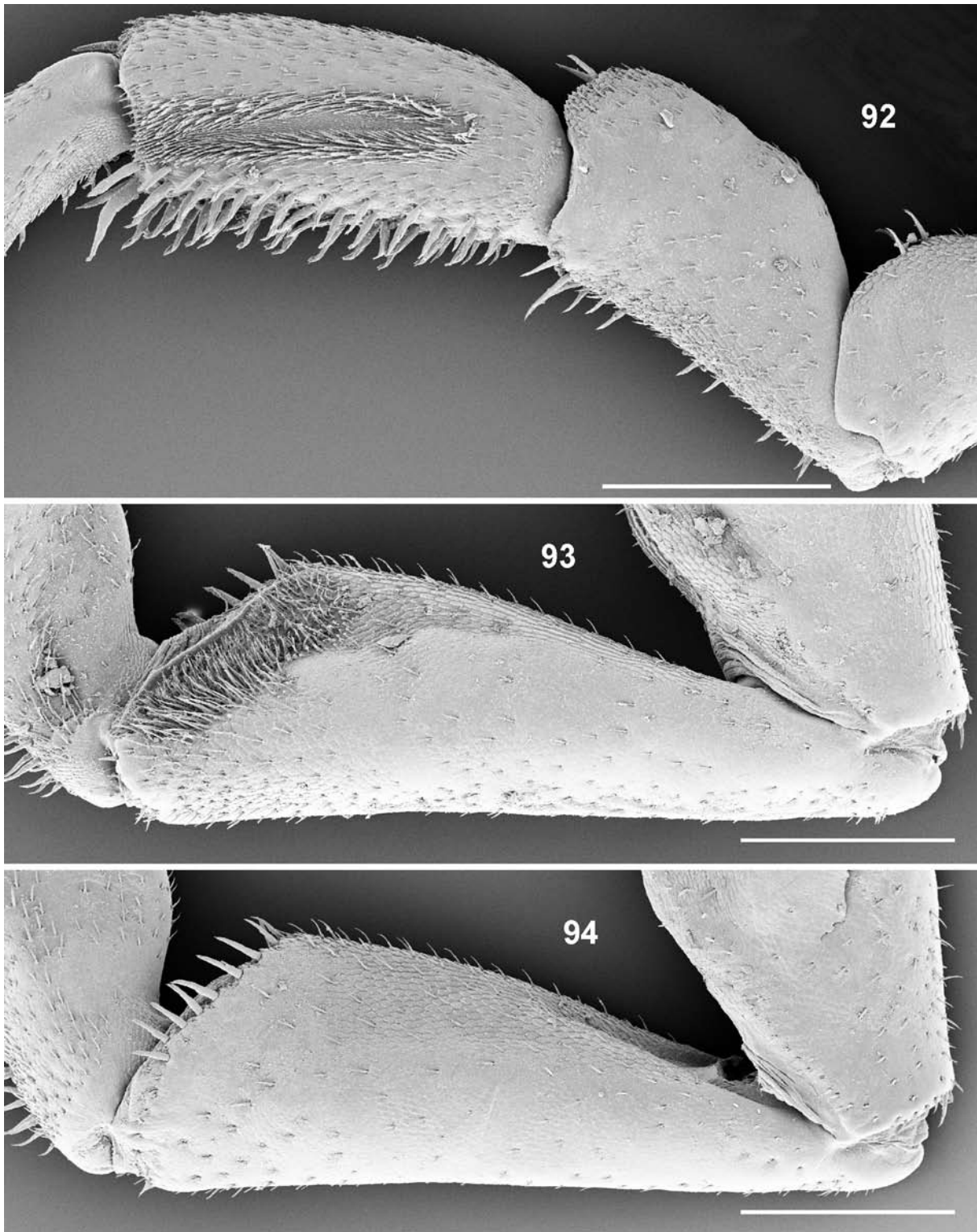

Fig. 88. Known records of *Armadillidium pangaionum* n. sp. (●) and *A. sfenthourakisi* n. sp. (■).



Figs. 89–91. *Armadillidium sfenthourakisi* n. sp., paratypes from type locality (Litókhoro, SMNS 1701). – **89.** ♂, 16.5×7.8 mm, head, dorsal view. **90.** ♂, 16.5×8.0 mm, head, frontal view. **91.** ♂, 16.5×8.0 mm, antenna. – Scales: 1 mm.



Figs. 92–94. *Armadillidium sfenthourakisi* n. sp., paratype from type locality (Litókhoro, SMNS 1701). – 92. Pereiopod 1, frontal view. 93. Ischium 7, frontal view. 94. Ischium 7, caudal view. – Scales: 0.5 mm.

3.13 *Armadillidium tuberculatum* n.sp.
(Figs. 98–107, map Fig. 108)

Material examined

Holotype: ♂, 9.0×3.8 mm, Greece, northern mainland, prefecture Kavála, SW of Pangéo Mountain, Galipsós, maquis, leg. SCHMALFUSS, 5.V.1990 (SMNS T604).

Paratypes: 13 ex., same data as holotype (SMNS 2273). – 21 ex., prefecture Kavála, 15 km SW of Kavála, Néa Iraklitsa, beach, leg. SCHMALFUSS, 5.V.1990 (SMNS 2272). – 3 ex., prefecture Kavála, Pangéo Mountain, southern side, 2 km W of Podokhóri, leg. PIEPER, 19.IV.1987 (SMNS 2233). – 8 ex., prefecture Kavála, Pangéo Mountain, southern side, 550 m, maquis, leg. SCHMALFUSS, 3.V.1990 (SMNS 2276). – 13 ex., prefecture Kavála, 5 km W of Eleftherúpoli, maquis, *Quercus, Platanus*, leg. SCHMALFUSS, 29.IV.1994 (SMNS 2432). – 16 ex., prefecture Kavála, SW of Kavála, Simvoló Mountain, 700 m, maquis, leg. SCHMALFUSS, 2.V.2002 (SMNS 2734).

Derivatio nominis

The name of the species is derived from the very conspicuous tuberculation of the tergal parts.

Diagnostic characters

Maximum dimensions: 10.0×3.8 mm.

Coloration: Tergites light brown, epimera yellowish.

Cuticular structures: Tergites conspicuously tuberculated (Figs. 98, 100).

Frontal shield from behind surpassing frontal margin of head, upper margin straight, rounded obtuse angles laterally, caudally with conspicuous groove (Fig. 99); antennal lobes trapezoidal (Fig. 100). Hind margin of pereion-epimeron 1 with obtuse angle (Fig. 105). Telson wider than long, with nearly straight sides and truncate apex (Fig. 106). Antenna see Fig. 101, distal segment of the flagellum slightly longer than proximal one. Male carpus 1 with brush of short spines (Fig. 102); male ischium 7 ventrally very slightly concave, frontally with distal field of tiny setae (Figs. 103–104). Male pleopod-exopodite 1 with short rounded triangular hind-lobe (Fig. 107), endopodite 1 with apex straight.

Distribution

Northern Greece, coastal region in the prefecture Kavála (map Fig. 108).

Remarks

The species shows affinities to *A. bicurvatum* and *A. peloponnesiacum* (compare SCHMALFUSS 2006a). The main differences towards *A. bicurvatum* are: lack of a duplocarinate frons, posterior margin of epimeron 1 with pronounced angle, proximal segment of antennal flagellum two thirds as long as distal segment. *A. peloponnesiacum* exhibits a very different morphology of the male ischium 7 (ventrally strongly concave with a peculiar ventral-proximal scale field, see SCHMALFUSS 2006a: 77–78, figs. 169–170).

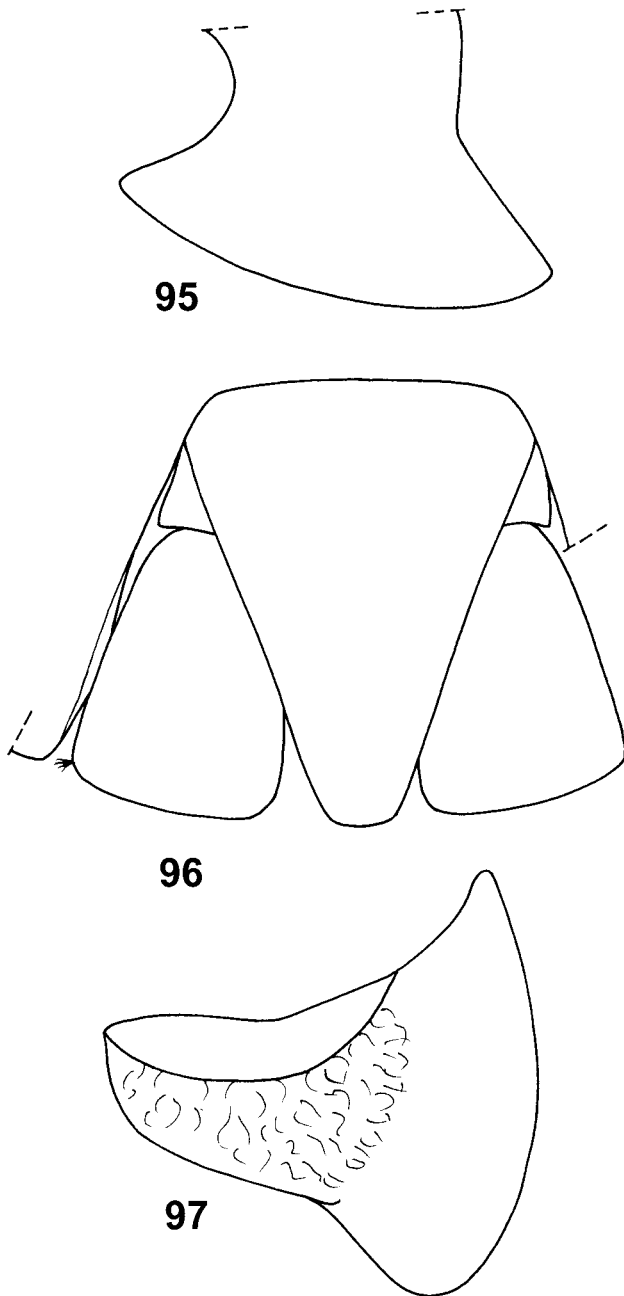

Figs. 95–97. *Armadillidium sfenthourakisi* n.sp., ♂, 18.0×7.8 mm, holotype (SMNS T605). – **95.** Pereion-epimeron 1, lateral view. **96.** Telson and uropods in situ, dorsal view. **97.** Pleopod-exopodite 1, dorsal view.

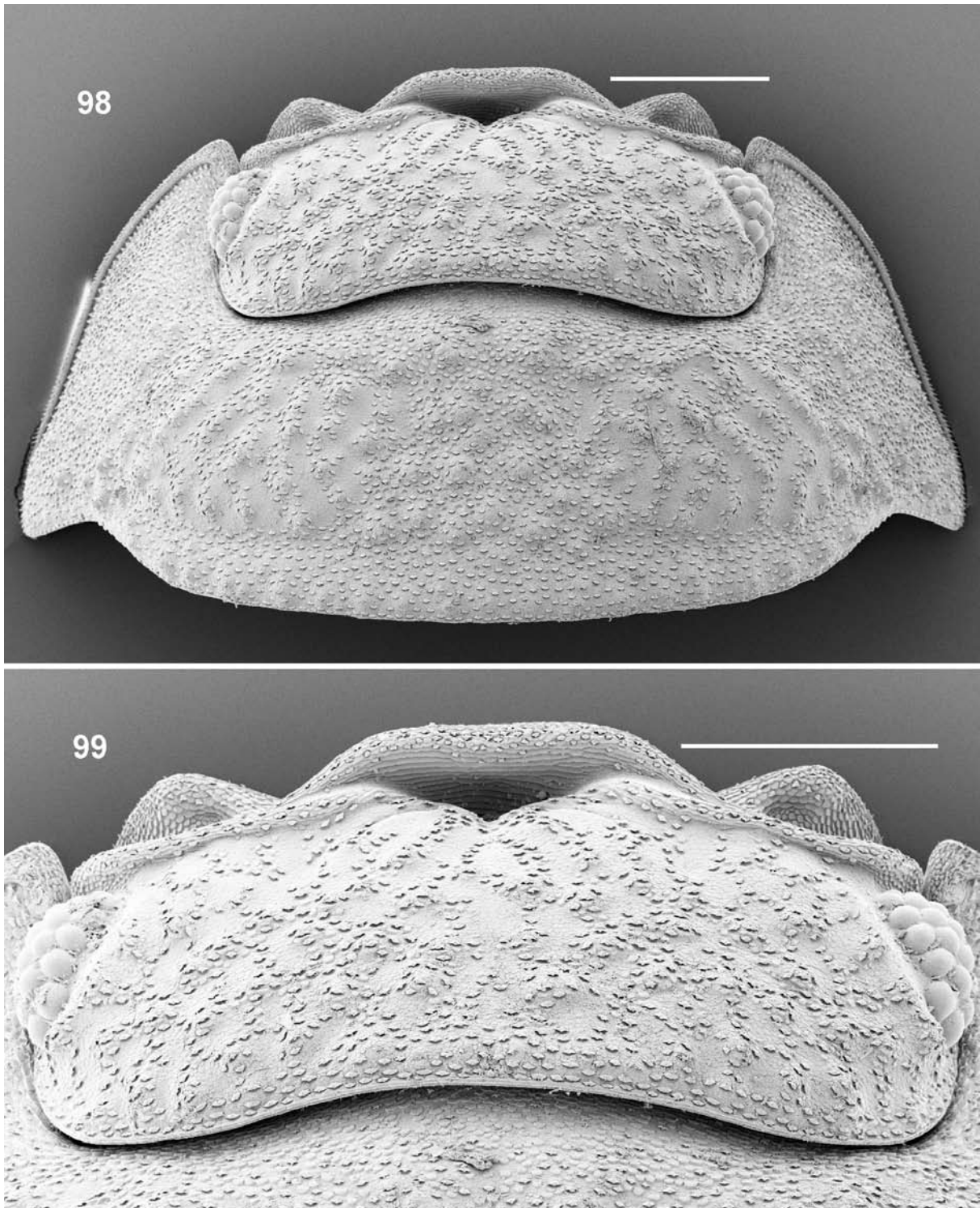

Figs. 98–99. *Armadillidium tuberculatum* n. sp., ♂, 7.8×3.5 mm, paratype from type locality (Pangéo Mountain, SMNS 2273). – 98. Head and pereion-tergite 1, dorsal view. 99. Head, dorsal view. – Scales: 0.5 mm.

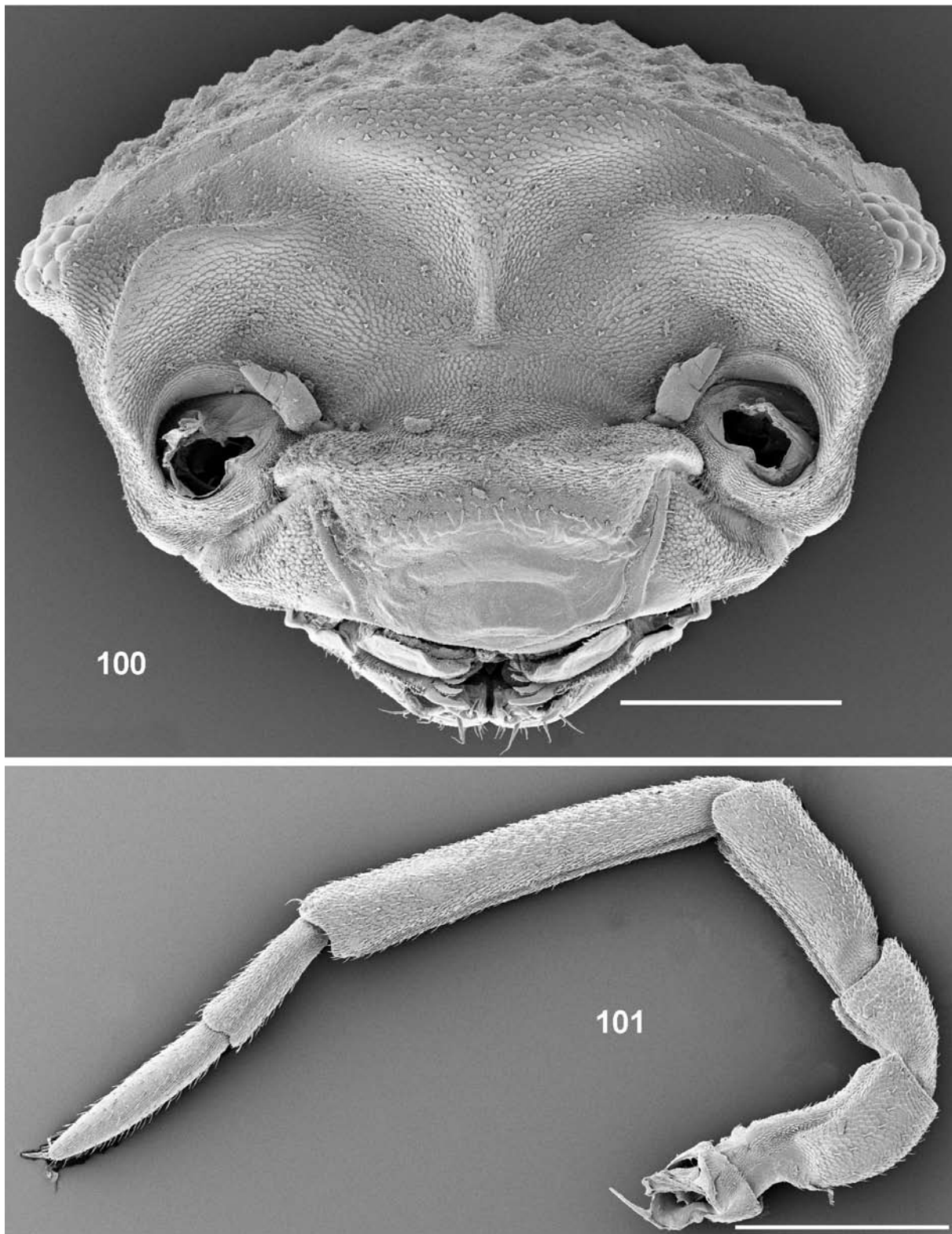

Figs. 100–101. *Armadillidium tuberculatum* n.sp., paratypes from type locality (Pangéo Mountain, SMNS 2273). – **100.** ♀, 10.2×4.0 mm, head, frontal view. **101.** ♂, 7.8×3.5 mm, antenna. – Scales: 0.5 mm.

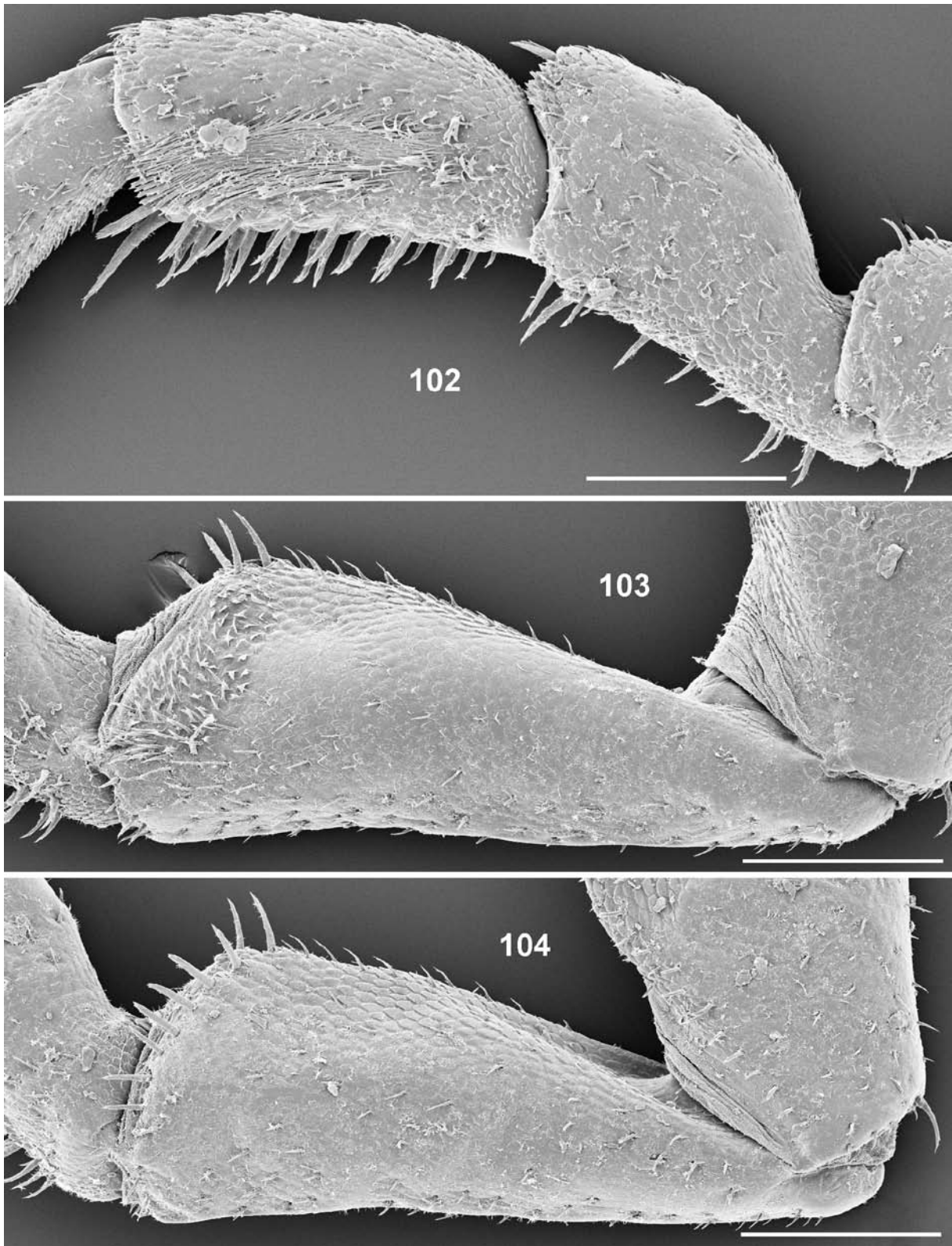

Figs. 102–104. *Armadillidium tuberculatum* n. sp., ♂, 7.8×3.5 mm, paratype from type locality (Pangéo Mountain, SMNS 2273). – **102.** Pereiopod 1, frontal view. **103.** Ischium 7, frontal view. **104.** Ischium 7, caudal view. – Scales: 0.2 mm.

3.14 *Armadillidium vulgare* (Latreille, 1804)

This species was again treated in the 23rd contribution of this series (SCHMALFUSS 2006a). It originated with great probability in southeastern Europe and has been transported by human activities to all parts of the world, where it thrives mostly in disturbed biotopes where the indigenous fauna was destroyed together with the original vegetation for agricultural reasons. A map of all Greek records is given in SCHMALFUSS (2006a).

4 References

- FRANKENBERGER, Z. (1941): Isopodes terrestres de la frontière alban-yougoslave. – Bulletin international, Académie tchèque des Sciences **42**: 1–15.
- SCHMALFUSS, H. (1981): Die Landisopoden (Oniscoidea) Griechenlands. 2. Beitrag: Gattung *Armadillidium*, Teil I (Armadillidiidae). – Spixiana **4**: 275–289.
- SCHMALFUSS, H. (1985): Die Landisopoden (Oniscoidea) Griechenlands. 6. Beitrag: Gattung *Armadillidium*, Teil III (Armadillidiidae). – Sitzungsberichte der österreichischen Akademie der Wissenschaften, mathematisch-naturwissenschaftliche Klasse, Abteilung I, **193**: 289–301.
- SCHMALFUSS, H. (2000): Distributional patterns in the Greek species of the terrestrial isopod genus *Armadillidium* Brandt, 1833. – Belgian Journal of Zoology **130** (Supplement): 77–82.
- SCHMALFUSS, H. (2003): World catalog of terrestrial isopods (Isopoda: Oniscoidea). – Stuttgarter Beiträge zur Naturkunde, Serie A (Biologie) **654**: 341 pp. <http://www.naturkunde.museum-bw.de/stuttgart/projekte/oniscoidea-catalog>.
- SCHMALFUSS, H. (2006a): The terrestrial isopods (Isopoda: Oniscoidea) of Greece. 23rd contribution: The genus *Armadillidium* (Armadillidiidae) on the Peloponnese. – Stuttgarter Beiträge zur Naturkunde, Serie A (Biologie) **693**: 102 pp.
- SCHMALFUSS, H. (2006b): The terrestrial isopods (Isopoda: Oniscoidea) of Greece. 24th contribution: The genus *Armadillidium* (Armadillidiidae) on the Aegean islands. – Stuttgarter Beiträge zur Naturkunde, Serie A (Biologie) **698**: 43 pp.
- SFENTHOURLAKIS, S. (1992): Altitudinal effect on species richness of Oniscoidea (Crustacea; Isopoda) on three mountains in Greece. – Global Ecology and Biogeography Letters **2**: 157–164.
- STROUHAL, H. (1956): Zoologische Studien in West-Griechenland. VI. Teil. Isopoda terrestria, II.: Armadillidiidae. – Sitzungsberichte der österreichischen Akademie der Wissenschaften, mathematisch-naturwissenschaftliche Klasse, Abteilung I, **165**: 585–618.
- VANDEL, A. (1962): Isopodes terrestres (deuxième partie). – Faune de France **66**: 417–931; Paris (Lechevalier).
- VERHOEFF, K. (1902): Über paläarktische Isopoden. 8. Aufsatz: Armadillidien der Balkanhalbinsel und einiger Nachbarländer, insbesondere auch Tirols und Norditaliens. – Zoologischer Anzeiger **25**: 241–255.
- VERHOEFF, K. (1907): Über paläarktische Isopoden. 9. Aufsatz: Neuer Beitrag zur Kenntnis der Gattung *Armadillidium*. – Zoologischer Anzeiger **31**: 457–505.
- VERHOEFF, K. (1930): Zur Kenntnis osteuropäischer Isopoden. – Zoologische Jahrbücher, Abteilung für Systematik, Ökologie und Geographie der Tiere **59**: 1–64, pls. 1–3.

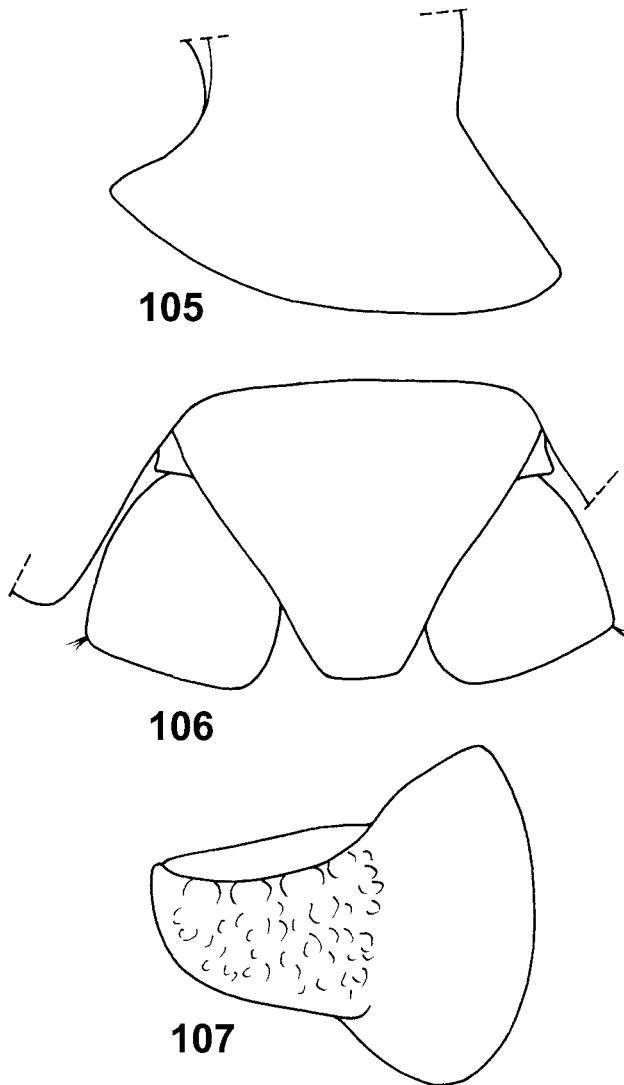

Figs. 105–107. *Armadillidium tuberculatum* n.sp., ♂, 9.0 × 3.8 mm, holotype (SMNS T604). – **105.** Pereion-epimeron 1, lateral view. **106.** Telson and uropods in situ, dorsal view. **107.** Pleopod-exopodite 1, dorsal view.

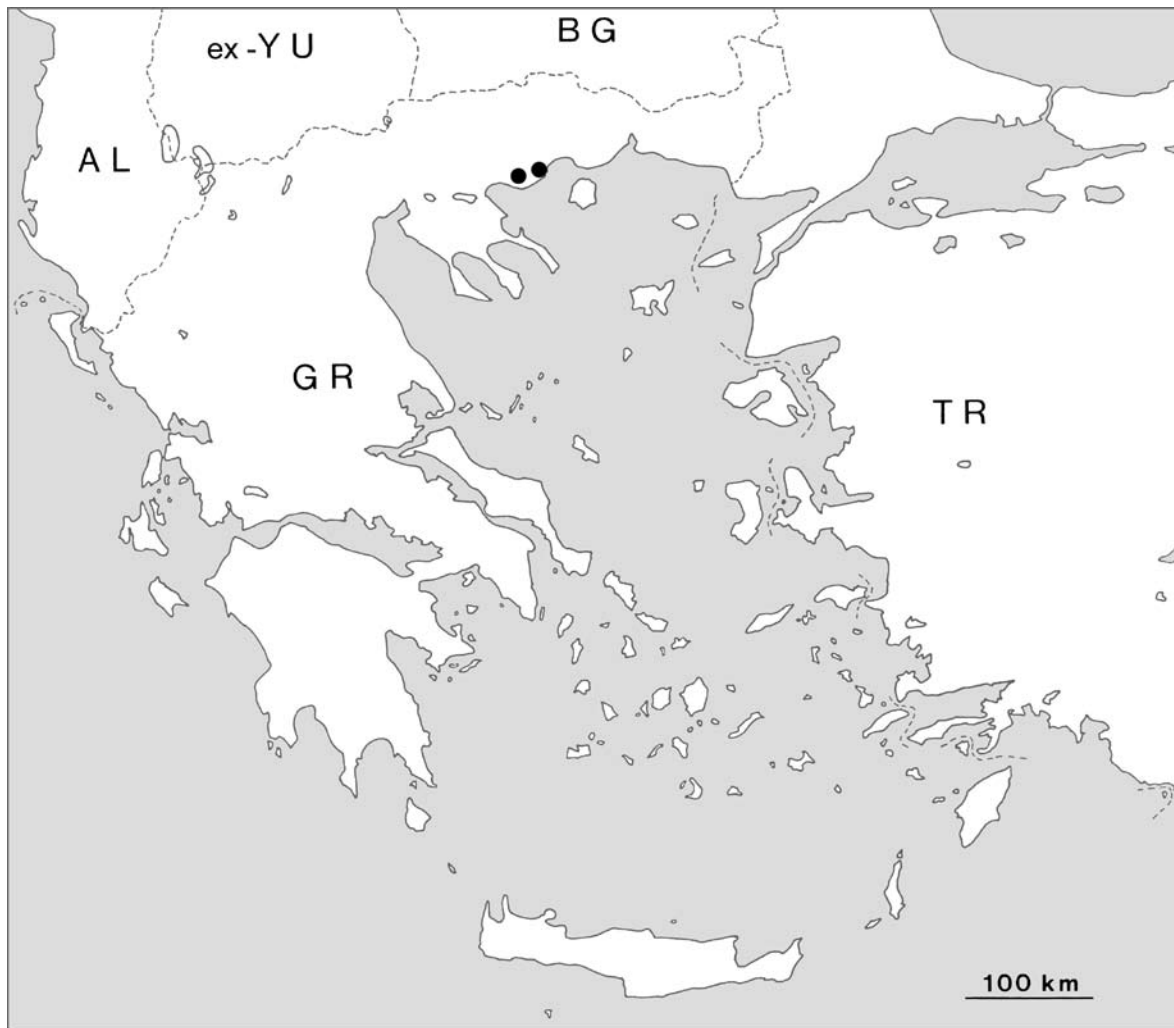

Fig. 108. Known records of *Armadillidium tuberculatum* n. sp.

Author's address:

Dr. HELMUT SCHMALFUSS, Staatliches Museum für Naturkunde, Rosenstein 1, 70191 Stuttgart, Germany;
e-mail: schmalfuss.smns@naturkundemuseum-bw.de

Manuscript received: 22.VIII.2007, accepted: 25.IX.2007.

ZOBODAT - www.zobodat.at

Zoologisch-Botanische Datenbank/Zoological-Botanical Database

Digitale Literatur/Digital Literature

Zeitschrift/Journal: [Stuttgarter Beiträge Naturkunde Serie A \[Biologie\]](#)

Jahr/Year: 2008

Band/Volume: [NS_1_A](#)

Autor(en)/Author(s): Schmalfluss Helmut

Artikel/Article: [The terrestrial isopods \(Isopoda: Oniscidea\) of Greece. 25th contribution: The genus *Armadillidium* \(Armadillidiidae\) in the provinces Macedonia and Thrace 153-201](#)